



**NEXCOM International Co., Ltd.**

**IoT Automation Solutions Business Group**

**PC-based Factory Automation System**

**NIFE 300 Series**

User Manual

# CONTENTS

## Preface

Copyright .....	iv
Disclaimer .....	iv
Acknowledgements .....	iv
Regulatory Compliance Statements .....	iv
Declaration of Conformity .....	iv
RoHS Compliance .....	v
Warranty and RMA .....	vi
Safety Information .....	viii
Installation Recommendations .....	viii
Safety Precautions .....	ix
Technical Support and Assistance .....	x
Conventions Used in this Manual .....	x
Global Service Contact Information .....	xi
Package Contents .....	xiii
Ordering Information .....	xiv

## Chapter 1: Product Introduction

Overview .....	1
Key Features .....	1
Hardware Specifications .....	2
Knowing Your NIFE 300 Series .....	4
Front View .....	4
Top View .....	5
Mechanical Dimensions .....	6

NIFE 300 .....	6
NIFE 300P2/NIFE 300P2E/NIFE 300E16 .....	7
NIFE 300P3 .....	8

## Chapter 2: Jumpers and Connectors

Before You Begin .....	9
Precautions .....	9
Jumper Settings .....	10
Locations of the Jumpers and Connectors for NIFB 300 .....	11
Top View .....	11
Bottom View .....	12
Jumpers .....	13
AT/ATX Mode Select .....	13
CMOS Clear Select .....	13
COM3 RI Select .....	14
PCH Config Pin Header .....	14
PCIe Configuration Settings .....	15
Connector Pin Definitions .....	16
External I/O Interfaces - Front Panel .....	16
24V DC Power Input .....	16
COM 1 Port (RS232/422/485) .....	16
COM 2 Port (RS232/422/485) .....	17
LAN3 and USB 2.0 Ports .....	18
LAN2 and USB 3.0 Ports .....	19
LAN1 and USB 3.0 Ports .....	20
DVI-D Connector .....	21

HDMI .....	21
Audio Connectors .....	22
LED Indicators .....	22
Internal Connectors .....	23
System Fan Connector .....	23
LED Pin Header .....	23
Debug Port .....	24
SMBus .....	24
Remote Power On/Off & S3 Connector .....	25
COM3 and COM4 Connector .....	25
USB 2.0 Connector .....	26
Line-in Pin Header .....	26
SATA Power Connectors.....	27
SATA Connectors .....	27
SIM Card Slot.....	28
GPIO Pin Header .....	28
Reset Connector .....	29
Power Connector.....	29
Power Button.....	30
EDP.....	30
CFast .....	31
PS2 KB/MS Pin Header .....	31
Mini-PCIe Connector (WLAN/GSM) .....	32
Mini-PCIe/mSATA Connector.....	33
PCIe x16 Slot.....	34

## Chapter 3: System Setup

Installing a CPU.....	36
Installing a SO-DIMM Memory Module .....	41
Installing a SIM Card .....	44
Installing a CFast Card .....	46
Installing a 3G/GSM Module .....	48

Installing an mSATA Module (NIFE 300 Only).....	51
Installing an mSATA Module (NIFE 300P2/P3/P2E/E16/E3) .....	53
Installing an External SATA Hard Drive .....	55
Installing an Internal SATA Hard Drive .....	57
Installing a PCI or PCIe Card.....	59
PCI Volts Configuration on NIFE 300 Riser Cards.....	61
Wallmount Mounting .....	62

## Chapter 4: BIOS Setup

About BIOS Setup .....	63
When to Configure the BIOS.....	63
Default Configuration .....	64
Entering Setup .....	64
Legends .....	64
BIOS Setup Utility.....	66
Main .....	66
Advanced .....	67
Chipset.....	74
Security .....	78
Boot.....	78
Save & Exit .....	79

## Appendix A: Power Consumption .....81

## Appendix B: Watchdog Programming Guide.....82

## Appendix C: GPI/O Programming Guide .....83

## Appendix D: Riser Card 3.3V and 5V Jumper Configuration ....85

# PREFACE

## Copyright

This publication, including all photographs, illustrations and software, is protected under international copyright laws, with all rights reserved. No part of this manual may be reproduced, copied, translated or transmitted in any form or by any means without the prior written consent from NEXCOM International Co., Ltd.

## Disclaimer

The information in this document is subject to change without prior notice and does not represent commitment from NEXCOM International Co., Ltd. However, users may update their knowledge of any product in use by constantly checking its manual posted on our website: <http://www.nexcom.com>. NEXCOM shall not be liable for direct, indirect, special, incidental, or consequential damages arising out of the use of any product, nor for any infringements upon the rights of third parties, which may result from such use. Any implied warranties of merchantability or fitness for any particular purpose is also disclaimed.

## Acknowledgements

NIFE 300, NIFE 300P2, NIFE 300P2E, NIFE 300E16 and NIFE 300P3 are trademarks of NEXCOM International Co., Ltd. All other product names mentioned herein are registered trademarks of their respective owners.

## Regulatory Compliance Statements

This section provides the FCC compliance statement for Class A devices and describes how to keep the system CE compliant.

## Declaration of Conformity

### FCC

This equipment has been tested and verified to comply with the limits for a Class A digital device, pursuant to Part 15 of FCC Rules. These limits are designed to provide reasonable protection against harmful interference when the equipment is operated in a commercial environment. This equipment generates, uses, and can radiate radio frequency energy and, if not installed and used in accordance with the instructions, may cause harmful interference to radio communications. Operation of this equipment in a residential area (domestic environment) is likely to cause harmful interference, in which case the user will be required to correct the interference (take adequate measures) at their own expense.

### CE

The product(s) described in this manual complies with all applicable European Union (CE) directives if it has a CE marking. For computer systems to remain CE compliant, only CE-compliant parts may be used. Maintaining CE compliance also requires proper cable and cabling techniques.



## RoHS Compliance



### **NEXCOM RoHS Environmental Policy and Status Update**

NEXCOM is a global citizen for building the digital infrastructure. We are committed to providing green products and services, which are compliant with European Union RoHS (Restriction on Use of Hazardous Substance in Electronic Equipment) directive 2011/65/EU, to be your trusted green partner and to protect our environment.

RoHS restricts the use of Lead (Pb) < 0.1% or 1,000ppm, Mercury (Hg) < 0.1% or 1,000ppm, Cadmium (Cd) < 0.01% or 100ppm, Hexavalent Chromium (Cr6+) < 0.1% or 1,000ppm, Polybrominated biphenyls (PBB) < 0.1% or 1,000ppm, and Polybrominated diphenyl Ethers (PBDE) < 0.1% or 1,000ppm.

In order to meet the RoHS compliant directives, NEXCOM has established an engineering and manufacturing task force to implement the introduction of green products. The task force will ensure that we follow the standard NEXCOM development procedure and that all the new RoHS components and new manufacturing processes maintain the highest industry quality levels for which NEXCOM are renowned.

The model selection criteria will be based on market demand. Vendors and suppliers will ensure that all designed components will be RoHS compliant.

### **How to recognize NEXCOM RoHS Products?**

For existing products where there are non-RoHS and RoHS versions, the suffix "(LF)" will be added to the compliant product name.

All new product models launched after January 2013 will be RoHS compliant. They will use the usual NEXCOM naming convention.

## Warranty and RMA

### NEXCOM Warranty Period

NEXCOM manufactures products that are new or equivalent to new in accordance with industry standard. NEXCOM warrants that products will be free from defect in material and workmanship for 2 years, beginning on the date of invoice by NEXCOM.

### NEXCOM Return Merchandise Authorization (RMA)

- Customers shall enclose the “NEXCOM RMA Service Form” with the returned packages.
- Customers must collect all the information about the problems encountered and note anything abnormal or, print out any on-screen messages, and describe the problems on the “NEXCOM RMA Service Form” for the RMA number apply process.
- Customers can send back the faulty products with or without accessories (manuals, cable, etc.) and any components from the card, such as CPU and RAM. If the components were suspected as part of the problems, please note clearly which components are included. Otherwise, NEXCOM is not responsible for the devices/parts.
- Customers are responsible for the safe packaging of defective products, making sure it is durable enough to be resistant against further damage and deterioration during transportation. In case of damages occurred during transportation, the repair is treated as “Out of Warranty.”
- Any products returned by NEXCOM to other locations besides the customers’ site will bear an extra charge and will be billed to the customer.

### Repair Service Charges for Out-of-Warranty Products

NEXCOM will charge for out-of-warranty products in two categories, one is basic diagnostic fee and another is component (product) fee.

#### System Level

- Component fee: NEXCOM will only charge for main components such as SMD chip, BGA chip, etc. Passive components will be repaired for free, ex: resistor, capacitor.
- Items will be replaced with NEXCOM products if the original one cannot be repaired. Ex: motherboard, power supply, etc.
- Replace with 3rd party products if needed.
- If RMA goods can not be repaired, NEXCOM will return it to the customer without any charge.

#### Board Level

- Component fee: NEXCOM will only charge for main components, such as SMD chip, BGA chip, etc. Passive components will be repaired for free, ex: resistors, capacitors.
- If RMA goods can not be repaired, NEXCOM will return it to the customer without any charge.

## Warnings

Read and adhere to all warnings, cautions, and notices in this guide and the documentation supplied with the chassis, power supply, and accessory modules. If the instructions for the chassis and power supply are inconsistent with these instructions or the instructions for accessory modules, contact the supplier to find out how you can ensure that your computer meets safety and regulatory requirements.

## Cautions

Electrostatic discharge (ESD) can damage system components. Do the described procedures only at an ESD workstation. If no such station is available, you can provide some ESD protection by wearing an antistatic wrist strap and attaching it to a metal part of the computer chassis.

## Safety Information

Before installing and using the device, note the following precautions:

- Read all instructions carefully.
- Do not place the unit on an unstable surface, cart, or stand.
- Follow all warnings and cautions in this manual.
- When replacing parts, ensure that your service technician uses parts specified by the manufacturer.
- Avoid using the system near water, in direct sunlight, or near a heating device.
- The load of the system unit does not solely rely for support from the rackmounts located on the sides. Firm support from the bottom is highly necessary in order to provide balance stability.
- The computer is provided with a battery-powered real-time clock circuit. There is a danger of explosion if battery is incorrectly replaced. Replace only with the same or equivalent type recommended by the manufacturer. Discard used batteries according to the manufacturer's instructions.

## Installation Recommendations

Ensure you have a stable, clean working environment. Dust and dirt can get into components and cause a malfunction. Use containers to keep small components separated.

Adequate lighting and proper tools can prevent you from accidentally damaging the internal components. Most of the procedures that follow require only a few simple tools, including the following:

- A Philips screwdriver
- A flat-tipped screwdriver
- A grounding strap
- An anti-static pad

Using your fingers can disconnect most of the connections. It is recommended that you do not use needle-nose pliers to disconnect connections as these can damage the soft metal or plastic parts of the connectors.

## Safety Precautions

1. Read these safety instructions carefully.
2. Keep this User Manual for later reference.
3. Disconnect this equipment from any AC outlet before cleaning. Use a damp cloth. Do not use liquid or spray detergents for cleaning.
4. For plug-in equipment, the power outlet socket must be located near the equipment and must be easily accessible.
5. Keep this equipment away from humidity.
6. Put this equipment on a stable surface during installation. Dropping it or letting it fall may cause damage.
7. The openings on the enclosure are for air convection to protect the equipment from overheating. **DO NOT COVER THE OPENINGS.**
8. Make sure the voltage of the power source is correct before connecting the equipment to the power outlet.
9. Place the power cord in a way so that people will not step on it. Do not place anything on top of the power cord. Use a power cord that has been approved for use with the product and that it matches the voltage and current marked on the product's electrical range label. The voltage and current rating of the cord must be greater than the voltage and current rating marked on the product.
10. All cautions and warnings on the equipment should be noted.
11. If the equipment is not used for a long time, disconnect it from the power source to avoid damage by transient overvoltage.
12. Never pour any liquid into an opening. This may cause fire or electrical shock.
13. Never open the equipment. For safety reasons, the equipment should be opened only by qualified service personnel.
14. If one of the following situations arises, get the equipment checked by service personnel:
  - a. The power cord or plug is damaged.
  - b. Liquid has penetrated into the equipment.
  - c. The equipment has been exposed to moisture.
  - d. The equipment does not work well, or you cannot get it to work according to the user's manual.
  - e. The equipment has been dropped and damaged.
  - f. The equipment has obvious signs of breakage.
15. Do not place heavy objects on the equipment.
16. The unit uses a three-wire ground cable which is equipped with a third pin to ground the unit and prevent electric shock. Do not defeat the purpose of this pin. If your outlet does not support this kind of plug, contact your electrician to replace your obsolete outlet.
17. **CAUTION: DANGER OF EXPLOSION IF BATTERY IS INCORRECTLY REPLACED. REPLACE ONLY WITH THE SAME OR EQUIVALENT TYPE RECOMMENDED BY THE MANUFACTURER. DISCARD USED BATTERIES ACCORDING TO THE MANUFACTURER'S INSTRUCTIONS.**

## Technical Support and Assistance

1. For the most updated information of NEXCOM products, visit NEXCOM's website at [www.nexcom.com](http://www.nexcom.com).
2. For technical issues that require contacting our technical support team or sales representative, please have the following information ready before calling:
  - Product name and serial number
  - Detailed information of the peripheral devices
  - Detailed information of the installed software (operating system, version, application software, etc.)
  - A complete description of the problem
  - The exact wordings of the error messages

### Warning!

1. Handling the unit: Carry the unit with both hands and handle it with care.
2. Maintenance: To keep the unit clean, use only approved cleaning products or clean with a dry cloth.
3. CFast: Turn off the unit's power before inserting or removing a CFast storage card.

## Conventions Used in this Manual



### Warning:

Information about certain situations, which if not observed, can cause personal injury. This will prevent injury to yourself when performing a task.



### Caution:

Information to avoid damaging components or losing data.



### Note:

Provides additional information to complete a task easily.



**Safety Warning:** This equipment is intended for installation in a Restricted Access Location only.

## Global Service Contact Information

### Headquarters

#### NEXCOM International Co., Ltd.

9F, No. 920, Chung-Cheng Rd.,  
Zhonghe District, New Taipei City, 23586,  
Taiwan, R.O.C.  
Tel: +886-2-8226-7786  
Fax: +886-2-8226-7782  
www.nexcom.com

### Asia

#### Taiwan

#### NexAIoT Headquarters

#### Industry 4.0 and Cloud Services

13F, No.916, Zhongzheng Rd.,  
Zhonghe District, New Taipei City,  
23586, Taiwan, R.O.C.  
Tel: +886-2-8226-7796  
Fax: +886-2-8226-7926  
Email: sales@nexaiot.com  
www.nexaiot.com

#### NexAIoT Co., Ltd.

#### Taichung Office

16F, No.250, Sec. 2, Chongde Rd.,  
Beitun District,  
Taichung City, 406, Taiwan, R.O.C.  
Tel: +886-4-2249-1179  
Fax: +886-4-2249-1172  
Email: sales@nexaiot.com  
www.nexaiot.com

#### NexCOBOT Taiwan Co., Ltd.

13F, No.916, Chung-Cheng Rd.,  
Zhonghe District,  
New Taipei City, 23586, Taiwan, R.O.C.  
Tel: +886-2-8226-7786  
Fax: +886-2-8226-7926  
Email: sales@nexcobot.com  
www.nexcobot.com

#### GreenBase Technology Corp.

13F, No.922, Chung-Cheng Rd.,  
Zhonghe District,  
New Taipei City, 23586, Taiwan, R.O.C.  
Tel: +886-2-8226-7786  
Fax: +886-2-8226-7900  
Email: sales@nexcom.com.tw  
www.nexcom.com.tw

#### EMBUX Technology Co., Ltd.

13F, No.916, Chung-Cheng Rd.,  
Zhonghe District,  
New Taipei City, 23586, Taiwan, R.O.C.  
Tel: +886-2-8226-7786  
Fax: +886-2-8226-7782  
Email: sales@nexcom.com.tw  
www.nexcom.com.tw

#### TMR Technology Corp.

13F, No.916, Chung-Cheng Rd.,  
Zhonghe District,  
New Taipei City, 23586, Taiwan, R.O.C.  
Tel: +886-2-8226-7786  
Fax: +886-2-8226-7782  
Email: sales@nexcom.com.tw  
www.nexcom.com.tw

### China

#### NEXSEC Incorporated

5F, No.4, No.7 Fengxian Middle Rd.,  
(Beike Industrial Park), Haidian District,  
Beijing, 100094, China  
Tel: +86-10-5704-2680  
Fax: +86-10-5704-2681  
Email: marketing@nexsec.cn  
www.nexsec.cn

#### NEXCOM Shanghai

No.4, 16 Building,  
Shanghai OMNI Tech & Science Park  
No. 1699, Douhui Rd.,  
Shanghai, 201108, China  
Tel: +86-21-5278-5868  
Fax: +86-21-3251-6358  
Email: sales@nexcom.cn  
www.nexcom.cn

## **NEXCOM Surveillance Technology Corp.**

5F, Building C, ZhenHan Industrial Zone,  
GanKeng Community, Buji Street,  
LongGang District,  
ShenZhen, 518112, China  
Tel: +86-755-8364-7768  
Fax: +86-755-8364-7738  
Email: steveyang@nexcom.com.tw  
www.nexcom.cn

## **NEXCOM United System Service**

Room 603/604, Huiyinmingzun Plaza Bldg. 1,  
No. 609, Yunlin East Rd.,  
Shanghai, 200062, China  
Tel: +86-21-5278-5868  
Fax: +86-21-3251-6358  
Email: renwang@nexcom.com.tw  
www.nexcom.cn

## **NEXGOL Chongqing**

1F, Building B4, Electronic 2nd Area,  
(Phoenix Lake Industrial Park), Yongchuan Dist.,  
Chongqing City, 402160, China  
Tel: +86-23-4960-9080  
Fax: +86-23-4966-5855  
Email: sales@nexgol.com.cn  
www.nexcobot.com/NexGOL

## **NexCOBOT China**

Room 501, Building 1, Haichuang Building,  
No.7 Qingyi Road, Guicheng Street,  
Nanhai District, Foshan City,  
Guangdong Province, 528314, China  
Tel: +86-757-8625-7118  
Email: sales@nexcobot.com  
www.nexcobot.com.cn

## **Beijing NexGemo Technology Co.,Ltd.**

5F, Gemotech Building, No.1, Development Rd.,  
Changping International Information Industry Base,  
Changping District,  
Beijing, 102206, China  
Tel: +86-10-8190-9328  
Fax: +86-10-8190-9456  
Email: sales@gemotech.cn  
www.nexgemo.cn

## **Japan**

### **NEXCOM Japan**

9F, Tamachi Hara Bldg.,  
4-11-5, Shiba Minato-ku,  
Tokyo, 108-0014, Japan  
Tel: +81-3-5419-7830  
Fax: +81-3-5419-7832  
Email: sales@nexcom-jp.com  
www.nexcom-jp.com

## **America**

### **USA NEXCOM USA**

46665 Fremont Blvd.,  
Fremont CA 94538, USA  
Tel: +1-510-656-2248  
Fax: +1-510-656-2158  
Email: sales@nexcom.com  
www.nexcomusa.com

## **Europe**

### **United Kingdom NEXCOM EUROPE**

10 Vincent Avenue,  
Crownhill Business Centre,  
Milton Keynes, Buckinghamshire  
MK8 0AB, United Kingdom  
Tel: +44-1908-267121  
Fax: +44-1908-262042  
Email: sales.uk@nexcom.eu  
www.nexcom.co.uk



## Package Contents

Before continuing, verify that the package that you received is complete. Your package should have all the items listed in the following table.

Item	Part Number	Description	Specification	Qty
1	4NCPF00310X00	Terminal Blocks 3P	3.81mm Female DIP Green	1
2	4NCPF00316X00	Terminal Blocks 3P	5.08mm Female 180D DIP Green	1
3	50311F0326X00	Flat Head Screw	F3x5 Nylok NI+Heat Treatment	8
4	50311F0330X00	Round Head Screw	P2x3 NI Nylok	4
5	5060600171X00	2.5 HDD Mylar E-LIN	96.2x70x0.1mm	1
6	5061500010X00	HDD Pulling Tab for NISE 4000	100x35mm T=0.45mm Silicon	1
7	6012200052X00	PE Zipper Bag #8	170x240mm, w/China RoHS Symbol	1
8	6012200053X00	PE Zipper Bag #3	100x70mm, w/China RoHS Symbol	2
9	60177A0489X00	NIFE 300 Quick Reference Guide VER:A Size:A4	Kramer	1
10	6029900037X00	DOW Corning 340 Silicone Heat Sink Compound (3g)		1
11	602DCD1113X00	NIFE 300 DVD Driver VER:1.0	JCL	1

## Ordering Information

The following information below provides ordering information for the NIFE 300 series.

- **NIFE 300 system (P/N: 10J70030000X0)**
- **NIFE 300P2 system (P/N: 10J70030001X0)**
- **NIFE 300P2E system (P/N: 10J70030002X0)**
- **NIFE 300P3 system (P/N: 10J70030003X0)**
- **NIFE 300E16 system (P/N: 10J70030004X0)**
- **24V, 120W AC to DC power adapter w/o power core (P/N: 7400120029X00) For all above systems**
- **24V, 180W AC to DC power adapter w/o power core (P/N: 7400180008X00) Also compatible for NIFE 300E16**

# CHAPTER 1: PRODUCT INTRODUCTION

## Overview



NIFE 300



NIFE 300P2/P2E/E16



NIFE 300P3

## Key Features

- Support 6th generation Intel® Core™ i7/i5/i3 LGA1151 socket type processors
- Intel® Q170 PCH
- 1 x DVI-D, and 1 x HDMI for dual independent display support
- 3 x Intel® GbE LAN ports; support WoL, teaming and PXE
- 4 x USB 3.0, 2 x USB 2.0 and 2 x RS232/422/485 auto
- 1 x front access 2.5" SATA HDD tray
- 2 x Mini-PCIe sockets support optional modules and mSATA device
- 1 x external CFast socket and 1 x SIM card socket
- Support +24VDC input; support ATX power mode
- PCI/PCIe expansions (NIFE 300P2/P2E/E16 and NIFE 300P3 only)

## Hardware Specifications

### CPU Support

- Support 6th generation Intel® Core™ i7/i5/i3 LGA socket type processors
  - Core™ i7-6700TE, quad core, 3.4GHz, 8M cache
  - Core™ i5-6500TE, quad core, 3.3GHz, 6M cache
  - Core™ i3-6100TE, dual core, 2.7GHz, 4M cache
  - Pentium® G4400TE, dual core, 2.9GHz, 3M cache
  - Celeron® G3900TE, dual core, 2.6GHz, 2M cache

### Main Memory

- 2 x DDR4 2133 SO-DIMM sockets, support up to 16GB

### Display Option

- Dual independent display
  - HDMI + DVI-D

### Front I/O Interface Status LEDs

- 1 x Battery/ 1 x C-Fast LEDs
- 4 x GPO status/ 2 x TX/ RX LEDs
- 1 x Power/ 1 x HDD access LEDs

### Front I/O Interface

- 1 x ATX power on/off switch
- 1 x HDMI and 1 x DVI-D
- 4 x USB 3.0 ports (900mA per each)
- 2 x USB 2.0 ports (500mA per each)
- 1 x Line-out and 1 x Mic-in
- 2 x Antenna holes for Wi-Fi/GSM
- 1 x Front access 2.5" HDD tray

- 1 x Mini-PCIe expansion supports optional modules
- 2 x RS232/422/485 auto with 2.5KV Isolation

### Top I/O Interface

- 1 x 3-pin remote switch
- 1 x CFast expansion
- 1 x SIM card

### Storage Device

- 1 x CFast (SATA 3.0)
- 1 x 2.5" HDD (external, SATA 3.0)
- 1 x 2.5" HDD (internal, SATA 3.0)
- 1 x mSATA (via internal Mini-PCIe socket)

### Expansion Slot

- NIFE 300: No expansion
- NIFE 300P2: Two PCI expansion slots
  - Add-on card length: 180mm max
  - Power consumption: 10W/ slot max
- NIFE 300P2E: One PCI expansion slot, and one PCIe x8 expansion slot
  - Add-on card length: 180mm max
  - Power consumption: 10W/ slot max
- NIFE 300P3: Two PCI expansion slots and one PCIe x8 expansion slot
  - Add-on card length: 180mm max
  - Power consumption: 10W/ slot max
- NIFE 300E16: One PCIe x16 expansion slot
  - Add-on card length: 180mm
  - Power consumption: 30W/ slot max

## Power Requirements

- AT/ATX power mode (default with ATX power mode)
- Power input: typical +24VDC +/- 20%
- Power adapter: optional AC to DC power adapter (+24Vdc, 120W)

## Dimensions

- NIFE 300: 90 mm(W) x 185mm (D) x 251mm (H)
- NIFE 300P2: 155 mm(W) x 185mm (D) x 251mm (H)
- NIFE 300P2E: 155 mm(W) x 185mm (D) x 251mm (H)
- NIFE 300E16: 155 mm(W) x 185mm (D) x 251mm (H)
- NIFE 300P3: 175 mm(W) x 185mm (D) x 251mm (H)

## Construction

- Aluminum and metal chassis with front access design

## Environment

- Operating Temperature:  
Ambient with air flow: -5°C to 55°C (according to IEC60068-2-1, IEC60068-2-2, IEC60068-2-14)
- Storage Temperature: -20°C to 85°C
- Relative Humidity: 10% to 93% (non-condensing)
- Shock Protection:
  - HDD: 20G, half sine, 11ms, IEC60068-27
  - CFast: 50G, half sine, 11ms, IEC60068-27
- Vibration protection w/HDD condition:
  - Random: 0.5Grms @ 5~500 Hz, IEC60068-2-64
  - Sinusoidal: 0.5Grms @ 5~500 Hz, IEC60068-2-6

## Certifications

- CE Approval
  - EN61000-4-2
  - EN61000-4-4
- FCC Class A
- LVD

## OS Support Lists

- Windows 7 32-bit and 64-bit
- Windows 8.1 32-bit and 64-bit

## Knowing Your NIFE 300 Series

### Front View

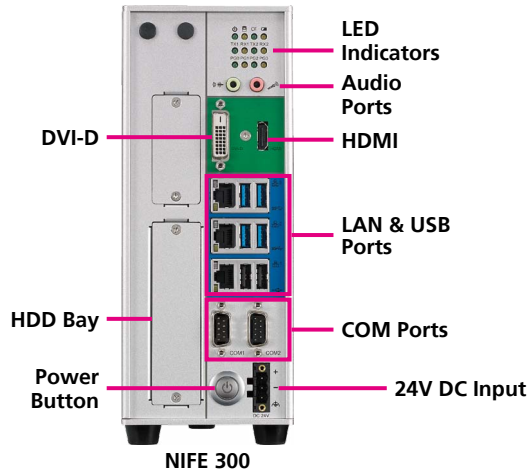

### LED Indicators

Indicates the power, hard drive, CFast, battery, COM1/2 and GPO activity of the system.

### Audio Ports

Line-out and mic-in ports to connect headphones, speakers or microphones.

### DVI-D

Used to connect a digital LCD panel.

### HDMI

Used to connect a high-definition display.

### LAN Ports

Three LAN ports used to connect the system to a local area network.

### USB Ports

USB 2.0 and USB 3.0 ports to connect the system with USB devices.

### HDD Bay

A hard drive bay used to install 2.5" HDDs.

### COM1 and COM2

Two DB9 ports used to connect RS232/422/485 compatible devices.

### Power Button

Press to power-on or power-off the system.

### 24V DC Input

Used to plug a DC power cord.

## Top View

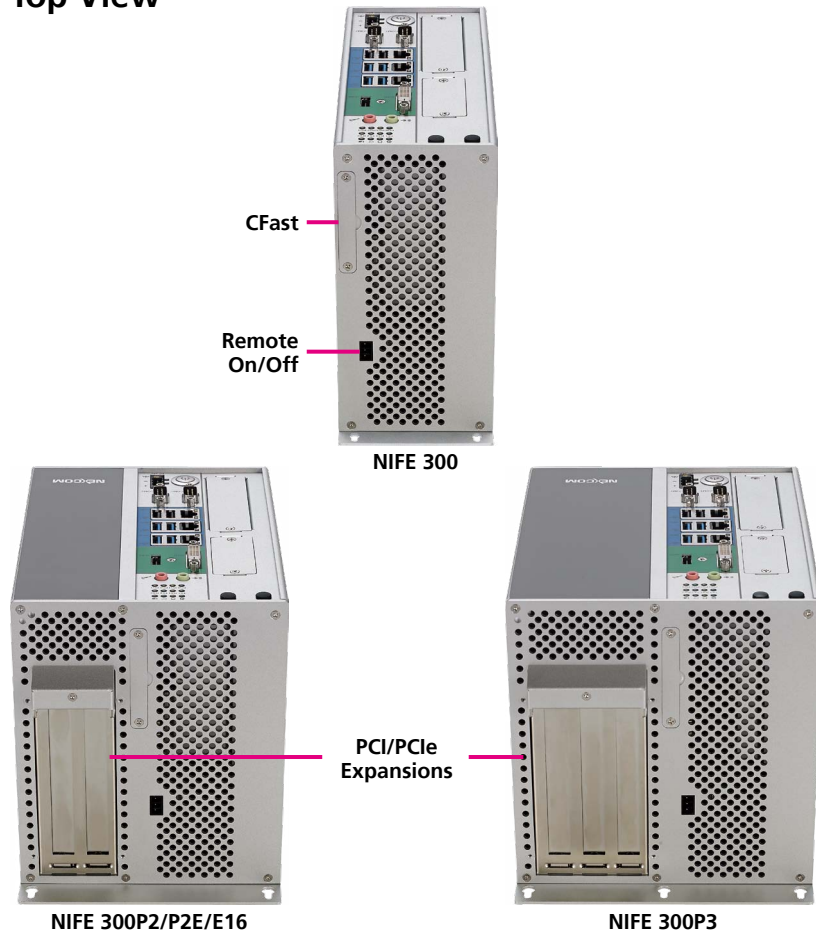

### PCI/PCIe Expansions

PCI/PCIe expansion slots for add-on cards.

NIFE 300: No expansion

NIFE 300P2: Two PCI expansion slots

NIFE 300P2E: One PCI expansion slot and one PCIe x8 expansion slot.

NIFE 300P3: Two PCI expansion slots and one PCIe x8 expansion slot.

NIFE 300E16: One PCIe x16 expansion slot.

### Remote On/Off Switch

Used to connect a remote to power on/off the system.

### CFast Slot

Used to insert a CFast card.

# Mechanical Dimensions

## NIFE 300

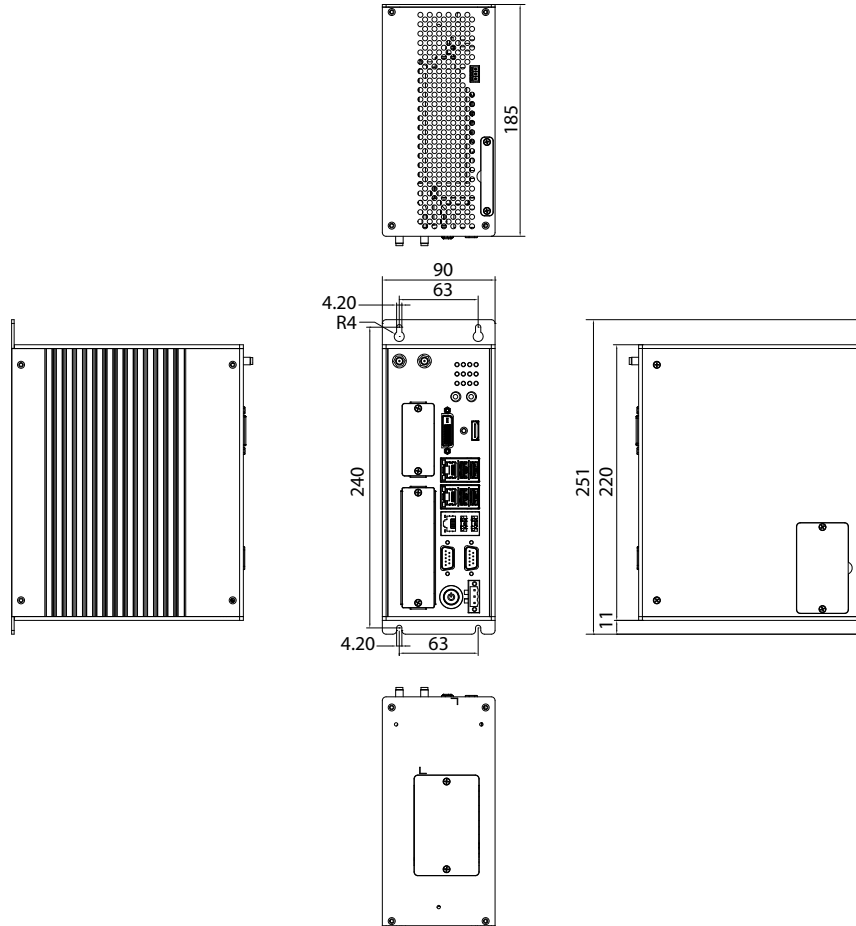



## NIFE 300P2/NIFE 300P2E/NIFE 300E16

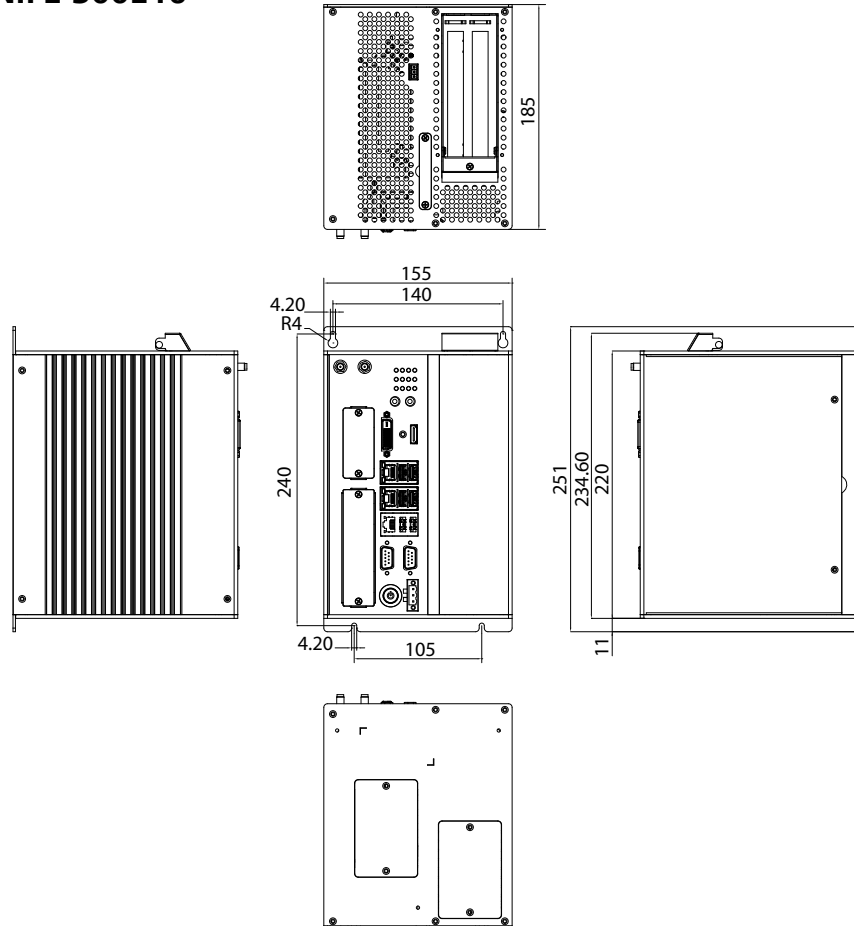

# NIFE 300P3

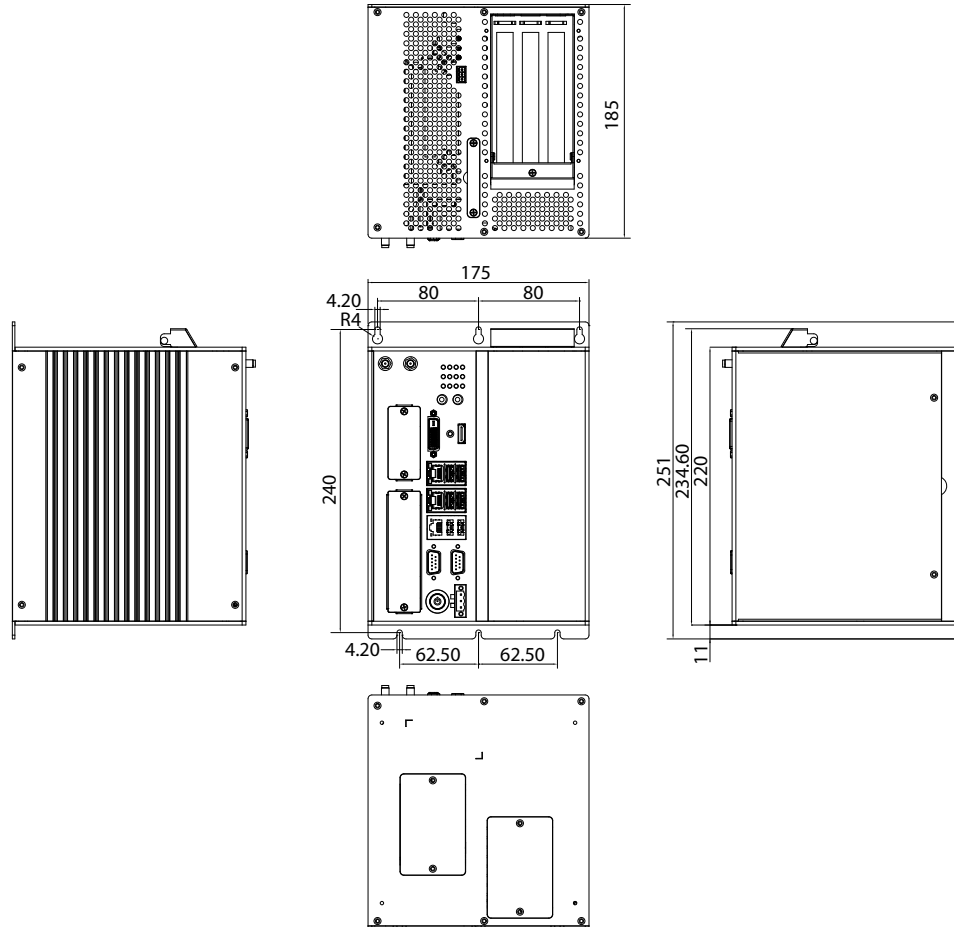

## CHAPTER 2: JUMPERS AND CONNECTORS

This chapter describes how to set the jumpers and connectors on the NIFE 300 series motherboard.

### Before You Begin

- Ensure you have a stable, clean working environment. Dust and dirt can get into components and cause a malfunction. Use containers to keep small components separated.
- Adequate lighting and proper tools can prevent you from accidentally damaging the internal components. Most of the procedures that follow require only a few simple tools, including the following:
  - A Philips screwdriver
  - A flat-tipped screwdriver
  - A set of jewelers screwdrivers
  - A grounding strap
  - An anti-static pad
- Using your fingers can disconnect most of the connections. It is recommended that you do not use needle-nosed pliers to disconnect connections as these can damage the soft metal or plastic parts of the connectors.
- Before working on internal components, make sure that the power is off. Ground yourself before touching any internal components, by touching a metal object. Static electricity can damage many of the electronic components. Humid environments tend to have less static electricity than

dry environments. A grounding strap is warranted whenever danger of static electricity exists.

### Precautions

Computer components and electronic circuit boards can be damaged by discharges of static electricity. Working on computers that are still connected to a power supply can be extremely dangerous.

Follow the guidelines below to avoid damage to your computer or yourself:

- Always disconnect the unit from the power outlet whenever you are working inside the case.
- If possible, wear a grounded wrist strap when you are working inside the computer case. Alternatively, discharge any static electricity by touching the bare metal chassis of the unit case, or the bare metal body of any other grounded appliance.
- Hold electronic circuit boards by the edges only. Do not touch the components on the board unless it is necessary to do so. Don't flex or stress the circuit board.
- Leave all components inside the static-proof packaging that they shipped with until they are ready for installation.
- Use correct screws and do not over tighten screws.

## Jumper Settings

A jumper is the simplest kind of electric switch. It consists of two metal pins and a cap. When setting the jumpers, ensure that the jumper caps are placed on the correct pins. When the jumper cap is placed on both pins, the jumper is short. If you remove the jumper cap, or place the jumper cap on just one pin, the jumper is open.

Refer to the illustrations below for examples of what the 2-pin and 3-pin jumpers look like when they are short (on) and open (off).

Two-Pin Jumpers: Open (Left) and Short (Right)

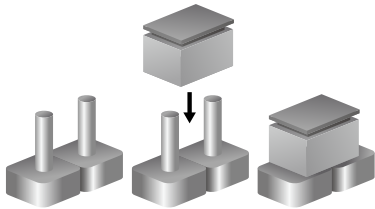

Three-Pin Jumpers: Pins 1 and 2 are Short

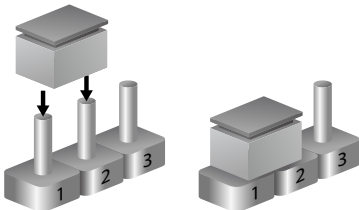

# Locations of the Jumpers and Connectors for NIFB 300

The figure below is the top view of the NIFB 300 main board which is the main board used in NIFE 300 series. It shows the locations of the jumpers and connectors.

Top View

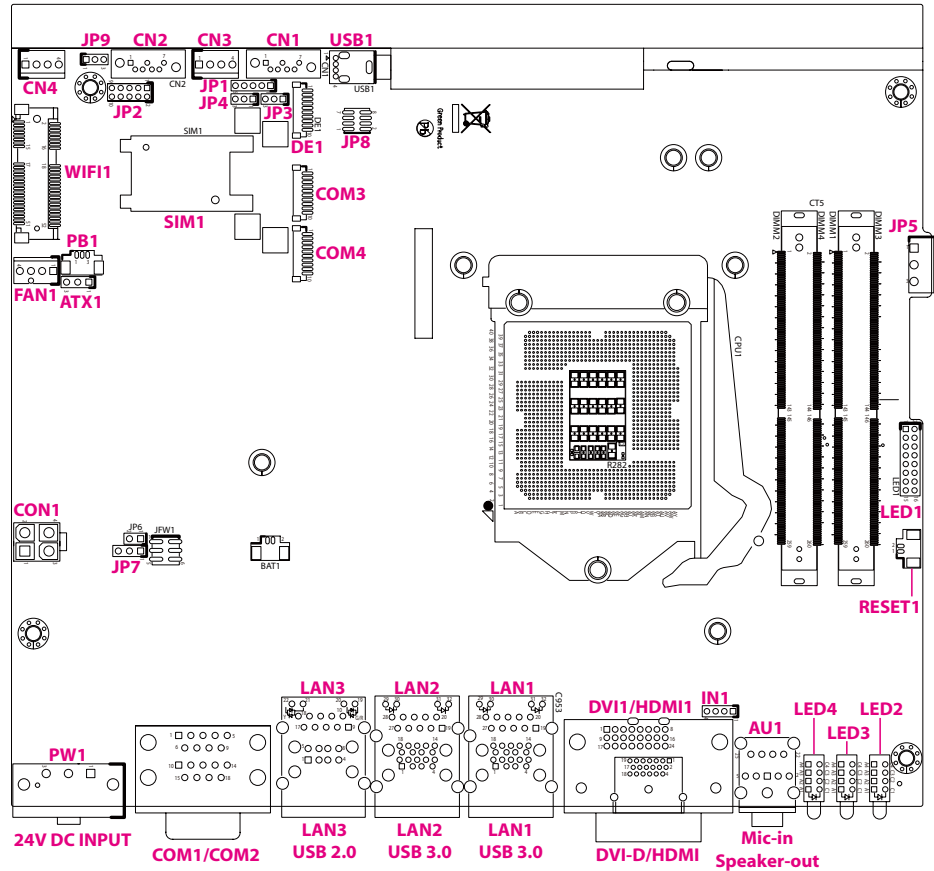

## Bottom View

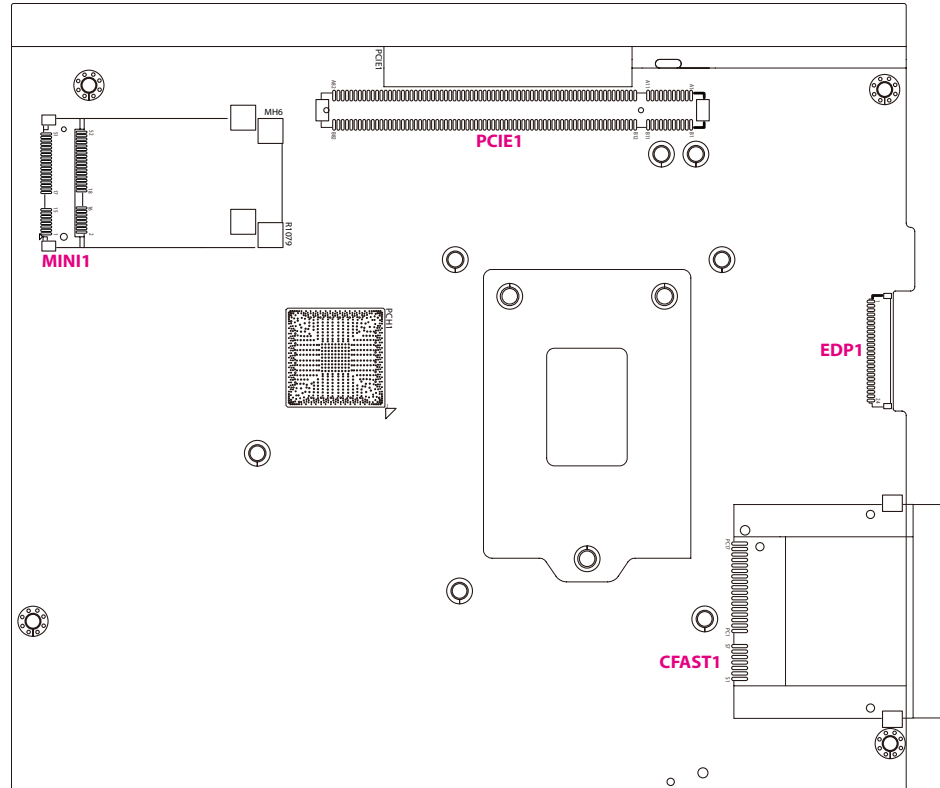

## Jumpers

### AT/ATX Mode Select

Connector type: 1x3 3-pin header

Connector location: ATX1



Pin	Settings
1-2 On	ATX Mode
2-3 On	AT Mode

1-2 On: default

### CMOS Clear Select

Connector type: 1x3 3-pin header

Connector location: JP7



Pin	Settings
1-2 On	Normal
2-3 On	Clear CMOS

1-2 On: default

## COM3 RI Select

Connector type: 1x3 3-pin header  
Connector location: JP1



Pin	Settings
1-2 On	VCC5
2-3 On	VCC12
4-5 On	RING

4-5 On: default

## PCH Config Pin Header

Connector type: 1x3 3-pin header  
Connector location: JP3



Pin	Settings
1-2 On	NORMAL
2-3 On	CONFIGURE
4-5 On	RECOVERY

1-2 On: default



## PCIe Configuration Settings

Connector type: 1x3 3-pin header

Connector location: JP9



Pin	Settings
1-2 On	PCIe x16
2-3 On	PCIe x8 + PCIe x8

1-2 On: default

## Connector Pin Definitions

### External I/O Interfaces - Front Panel

#### 24V DC Power Input

Connector type: Phoenix Contact 1x3 3-pin terminal block

Connector location: PW1

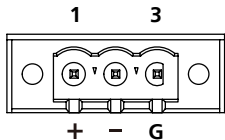

Pin	Definition	Pin	Definition
1	VIN_1	2	VIN_VSS
3	PWR_PIN3	MH1	NA
MH2	NA		

#### COM 1 Port (RS232/422/485)

Connector type: DB-9 port, 9-pin D-Sub

Connector location: COM1/COM2

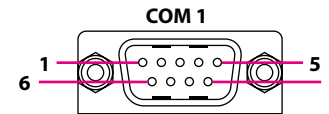

RS232		RS485		RS422	
Pin	Definition	Pin	Definition	Pin	Definition
1	SP1_DCD	1	SP1_DATA-	1	SP1_TX-
2	SP1_RXD	2	SP1_DATA+	2	SP1_TX+
3	SP1_TXD	3	NC	3	SP1_RX+
4	SP1_DTR	4	NC	4	SP1_RX-
5	GND	5	GND	5	GND
6	SP1_DSR	6	NC	6	SP1_RTS-
7	SP1_RTS	7	NC	7	SP1_RTS+
8	SP1_CTS	8	NC	8	SP1_CTS+
9	SP1_RI	9	NC	9	SP1_CTS-
MH2	REAR_GND	MH2	REAR_GND	MH2	REAR_GND
MH1	REAR_GND	MH1	REAR_GND	MH1	REAR_GND

## COM 2 Port (RS232/422/485)

Connector type: DB-9 port, 9-pin D-Sub

Connector location: COM1/COM2

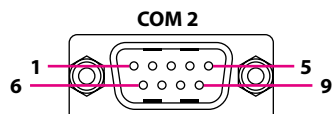

RS232		RS485		RS422	
Pin	Definition	Pin	Definition	Pin	Definition
1	SP2_DCD	1	SP2_DATA-	1	SP2_TX-
2	SP2_RXD	2	SP2_DATA+	2	SP2_TX+
3	SP2_TXD	3	NC	3	SP2_RX+
4	SP2_DTR	4	NC	4	SP2_RX-
5	GND	5	GND	5	GND
6	SP2_DSR	6	NC	6	SP2_RTS-
7	SP2_RTS	7	NC	7	SP2_RTS+
8	SP2_CTS	8	NC	8	SP2_CTS+
9	SP2_RI	9	NC	9	SP2_CTS-
MH2	REAR_GND	MH2	REAR_GND	MH2	REAR_GND
MH1	REAR_GND	MH1	REAR_GND	MH1	REAR_GND

## LAN3 and USB 2.0 Ports

Connector type: RJ45 port with LEDs and dual USB 2.0 ports, Type A

Connector location: LAN3A (USB) and LAN3B (LAN)

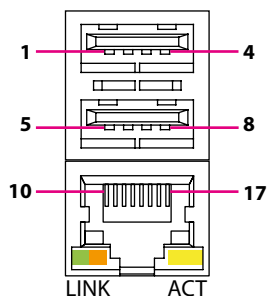

Act	Status
Flashing Yellow	Data activity
Off	No activity

Link	Status
Steady Green	1G network link
Steady Orange	100Mbps network link
Off	10Mbps or no link

### USB

Pin	Definition	Pin	Definition
1	P5V_USB_P45	2	USB2N4_C
3	USB2P4_C	4	GND
5	P5V_USB_P45	6	USB2N5_C
7	USB2P5_C	8	GND

### LAN3

Pin	Definition	Pin	Definition
9	LAN3_VCC	10	LAN3_MDI0P
11	LAN3_MDI0N	12	LAN3_MDI1P
13	LAN3_MDI1N	14	LAN3_MDI2P
15	LAN3_MDI2N	16	LAN3_MDI3P
17	LAN3_MDI3N	18	GND
19	LAN3_LINK100#_LED	20	LAN3_LINK
21	LAN3_ACT#_LED	22	LAN3_LED_P

## LAN2 and USB 3.0 Ports

Connector type: RJ45 port with LEDs and dual USB 3.0 ports, Type A

Connector location: LAN2A (USB) and LAN2B (LAN2)

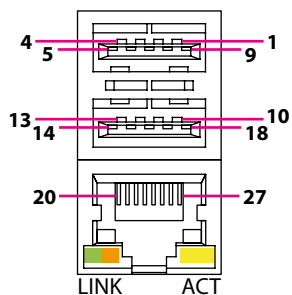

Act	Status
Flashing Yellow	Data activity
Off	No activity

Link	Status
Steady Green	1G network link
Steady Orange	100Mbps network link
Off	10Mbps or no link

### USB

Pin	Definition	Pin	Definition
1	P5V_USB_P01	2	USB2N0_C
3	USB2P0_C	4	GND
5	USB3RN1_C	6	USB3RP1_C
7	GND	8	USB3TN1_C
9	USB3TP1_C	10	P5V_USB_P01
11	USB2N1_C	12	USB2P1_C
13	GND	14	USB3RN2_C
15	USB3RP2_C	16	GND
17	USB3TN2_C	18	USB3TP2_C

### LAN2

Pin	Definition	Pin	Definition
19	LAN2_VCC	20	LAN2_MDI0P
21	LAN2_MDI0N	22	LAN2_MDI1P
23	LAN2_MDI1N	24	LAN2_MDI2P
25	LAN2_MDI2N	26	LAN2_MDI3P
27	LAN2_MDI3N	28	GND
29	LAN2_LINK100#_LED	30	LAN2_LINK
31	LAN2_ACT#_LED	32	LAN2_ACTPW

## LAN1 and USB 3.0 Ports

Connector type: RJ45 port with LEDs and dual USB 3.0 ports, Type A

Connector location: LAN1A (USB) and LAN1B (LAN1)

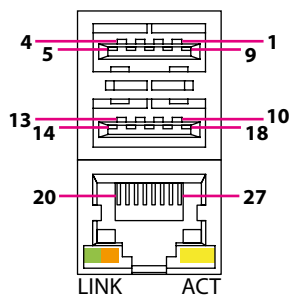

Act	Status
Flashing Yellow	Data activity
Off	No activity

Link	Status
Steady Green	1G network link
Steady Orange	100Mbps network link
Off	10Mbps or no link

### USB

Pin	Definition	Pin	Definition
1	P5V_USB_P01	2	USB2N0_C
3	USB2P0_C	4	GND
5	USB3RN1_C	6	USB3RP1_C
7	GND	8	USB3TN1_C
9	USB3TP1_C	10	P5V_USB_P01
11	USB2N1_C	12	USB2P1_C
13	GND	14	USB3RN2_C
15	USB3RP2_C	16	GND
17	USB3TN2_C	18	USB3TP2_C

### LAN1

Pin	Definition	Pin	Definition
19	LAN1_VCC	20	LAN1_MDI0P
21	LAN1_MDI0N	22	LAN1_MDI1P
23	LAN1_MDI1N	24	LAN1_MDI2P
25	LAN1_MDI2N	26	LAN1_MDI3P
27	LAN1_MDI3N	28	GND
29	LAN1_LINK100#_LED	30	LAN1_LINK
31	LAN1_ACT#_LED	32	LAN1_ACTPW

## DVI-D Connector

Connector type: 24-pin D-Sub, 2.0mm-M-180 (DVI)

Connector location: DVI1

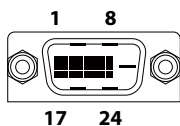

Pin	Definition	Pin	Definition
1	DVI1_DATA2_N_C	2	DVI1_DATA2_P_C
3	GND	4	NA
5	NA	6	DVI1_CTRL_CLK_C
7	DVI1_CTRL_DAT_C	8	NA
9	DVI1_DATA1_N_C	10	DVI1_DATA1_P_C
11	GND	12	NA
13	NA	14	DVI1_PWR_C
15	GND	16	DVI1_HPD
17	DVI1_DATA0_N_C	18	DVI1_DATA0_P_C
19	GND	20	NA
21	NA	22	NA
23	DVI1_CLK_P_C	24	DVI1_CLK_N_C
MH1	Chassis_GND	MH2	Chassis_GND
MH3	Chassis_GND	MH4	Chassis_GND

## HDMI

Connector type: HDMI port

Connector location: HDMI1

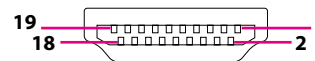

Pin	Definition	Pin	Definition
1	HDMI_DATA2_P_C	2	GND
3	HDMI_DATA2_N_C	4	HDMI_DATA1_P_C
5	GND	6	HDMI_DATA1_N_C
7	HDMI_DATA0_P_C	8	GND
9	HDMI_DATA0_N_C	10	HDMI_CLK_P_C
11	GND	12	HDMI_CLK_N_C
13	NA	14	NA
15	HDMI_CLK	16	HDMI_DAT
17	GND	18	HDMI_PWR_C
19	HDMI_HPD_C		
MH1	Chassis_GND	MH1	Chassis_GND

## Audio Connectors

Connector type: 2x 3.5mm TRS

Connector location: AU1

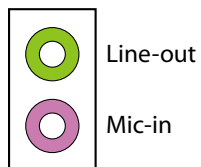

Pin	Definition	Pin	Definition
1	AGND	2	MIC_OUT-L
3	AGND	4	MIC_JD
5	MIC_OUT-R	MH1	Chassis_GND
MH2	Chassis_GND	MH3	Chassis_GND
MH4	Chassis_GND	NH1	
22	LINE_OUT_LC	23	AGND
24	LINEOUT_JD	25	LINE_OUT_RC

## LED Indicators

Connector location: LED2, LED3 and LED4

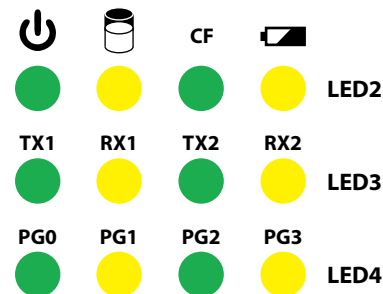

	Pin	Definition	Pin	Definition
LED2	A1	BAT_LOW	C1	GND
	A2	CFAST_DET_P	C2	CFAST_DET
	A3	SATALED#_P	C3	SATALED#
	A4	PWR_LED_P	C4	PWR_LED_N
LED3	A1	RX2_P	C1	COM2_RXLEDN
	A2	TX2_P	C2	COM2_TXLEDN
	A3	RX1_P	C3	COM1_RXLEDN
	A4	TX1_P	C4	COM1_TXLEDN
LED4	A1	SIO_GP36_64_P	C1	SIO_GP36_64
	A2	SIO_GP37_65_P	C2	SIO_GP37_65
	A3	SIO_GP15_66_P	C3	SIO_GP15_66
	A4	SIO_GP16_67_P	C4	SIO_GP16_67



## Internal Connectors

### System Fan Connector

Connector type: 1x4 4-pin Wafer, 2.54mm pitch

Connector location: FAN1

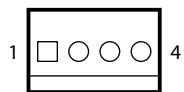

Pin	Definition	Pin	Definition
1	GND	2	VCC12
3	FAN TAC	4	FAN CTL

### LED Pin Header

Connector type: 2x8 16-pin header, 2.0mm pitch

Connector location: LED1

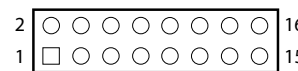

Pin	Definition	Pin	Definition
1	PWR_LED_P	2	PWR_LED_N
3	SATALED#_P	4	SATALED#
5	VCC3	6	LAN1_LED_LINK#
7	VCC3	8	LAN2_LED_LINK#
9	VCC3	10	LAN3_LED_LINK#
11	VCC3	12	LAN1_ACT#_LED
13	VCC3	14	LAN2_ACT#_LED
15	VCC3	16	LAN3_ACT#_LED

## Debug Port

Connector type: 1x10 10-pin header, 1.0mm pitch

Connector location: DE1



Pin	Definition	Pin	Definition
1	GND	2	RST_SIO_N
3	CLK_PCI_P80	4	LPC_FRAME#
5	LPC_AD3	6	LPC_AD2
7	LPC_AD1	8	LPC_ADO
9	VCC3	10	VCC3
MH1	GND	MH2	GND

## SMBus

Connector type: 1x3 3-pin header, 2.0mm pitch

Connector location: JP4



Pin	Definition
1	SMB_CLK
2	SMB_DAT
3	GND

## Remote Power On/Off & S3 Connector

Connector type: 3-pin terminal block connector, 3.81mm pitch

Connector location: JP5

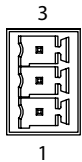

Pin	Definition
1	PWRBTN#_J
2	GND
3	SLP_S3#_C

## COM3 and COM4 Connector

Connector type: 1x10 10-pin header

Connector location: COM3 and COM4



Pin	Definition	Pin	Definition
1	COM_DCD#3	2	COM_RXD3
3	COM_TXD3	4	COM_DTR#3
5	GND	6	COM_DSR#3
7	COM_RTS#3	8	COM_CTS#3
9	COM_RI#3_T	10	GND
MH1	GND	MH2	GND

## USB 2.0 Connector

Connector type: USB port

Connector location: USB1



Pin	Definition	Pin	Definition
1	P5V_USB_P8	2	USB2N8_C
3	USB2P8_C	4	GND
MH1	GND	MH2	GND
MH3	GND		

## Line-in Pin Header

Connector type: 1x4 4-pin header, 2.0mm pitch

Connector location: IN1

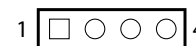

Pin	Definition	Pin	Definition
1	LINE1-L1	2	AGND
3	LINEIN_JD	4	LINE1-R1

## SATA Power Connectors

Connector type: 1x4 4-pin Wafer, 2.54mm pitch

Connector location: CN3 and CN4

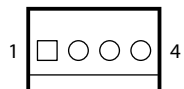

Pin	Definition	Pin	Definition
1	VCC12	2	GND
3	GND	4	VCC5

## SATA Connectors

Connector type: Standard Serial ATA 7P (1.27mm, SATA-M-180)

Connector location: CN1 and CN2

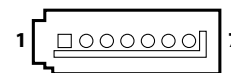

### CN1

Pin	Definition	Pin	Definition
1	GND	2	SATA_TXP0_C
3	SATA_TXN0_C	4	GND
5	SATA_RXN0_C	6	SATA_RXP0_C
7	GND		

### CN2

Pin	Definition	Pin	Definition
1	GND	2	SATA_TXP1_C
3	SATA_TXN1_C	4	GND
5	SATA_RXN1_C	6	SATA_RXP1_C
7	GND		

## SIM Card Slot

Connector location: SIM1

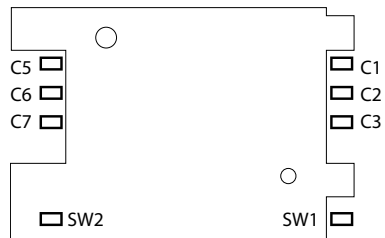

Pin	Definition	Pin	Definition
C1	UIM_PWR	C2	UIM_RESET
C3	UIM_CLK	C5	GND
C6	UIM_VPP	C7	UIM_DATA
SW1	GND	SW2	GND

## GPIO Pin Header

Connector type: 2x5 10-pin header, 2.0mm pitch

Connector location: JP2

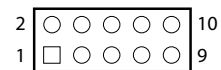

Pin	Definition	Pin	Definition
1	GPIO_PWR	2	GND
3	GPIO80	4	GPIO84
5	GPIO81	6	GPIO85
7	GPIO82	8	GPIO86
9	GPIO83	10	GPIO87

## Reset Connector

Connector type: 1x2 2-pin header, 1.25mm pitch

Connector location: RESET1

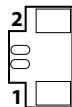

Pin	Definition
1	PM_RESET#_J
2	GND

## Power Connector

Connector type: 2x2 4-pin header

Connector location: CON1

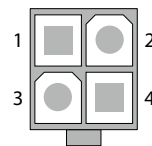

Pin	Definition	Pin	Definition
1	GND	2	GND
3	VIN_3	4	VIN_3

## Power Button

Connector type: 1x3 3-pin header

Connector location: PB1

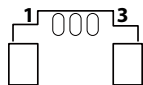

Pin	Definition
1	PWRBTN#_C
2	GND
3	PB_POWER

## EDP

Connector type: 1x24 24-pin header, 1.0mm pitch

Connector location: EDP1

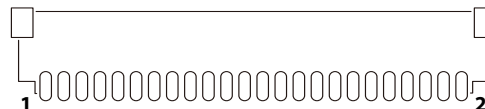

Pin	Definition	Pin	Definition
1	GND	2	GND
3	GND	4	EDP_DISP_UTIL
5	EDP_HPDP	6	EDP_BKLTEN
7	EDP_VDDEN	8	EDP_BKLTCTL
9	EDP_AUXN	10	EDP_AUXP
11	EDP_TXN3	12	EDP_TXP3
13	EDP_TXN2	14	EDP_TXP2
15	EDP_TXN1	16	EDP_TXP1
17	EDP_TXN0	18	EDP_TXP0
19	GND	20	VCC12
21	VCC12	22	VCC12
23	VCC3	24	VCC3
MH1	GND	MH2	GND



## CFast

Connector type: CFAST Socket

Connector location: CFAST1

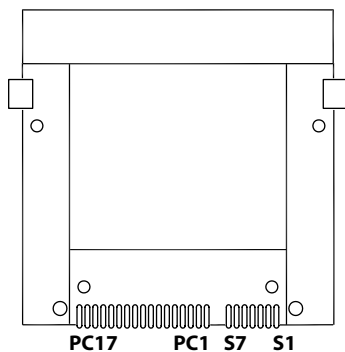

Pin	Definition	Pin	Definition
S1	GND	PC6	NA
S2	SATA_TP2_C	PC7	GND
S3	SATA_TN2_C	PC8	CFAST_LED1_C
S4	GND	PC9	CFAST_LED2_C
S5	SATA_RN2_C	PC10	NA
S6	SATA_RP2_C	PC11	NA
S7	GND	PC12	NA
PC1	CFAST_CDI	PC13	VCC3
PC2	GND	PC14	VCC3
PC3	NA	PC15	GND
PC4	NA	PC16	GND
PC5	NA	PC17	CFAST_CDO_C

## PS2 KB/MS Pin Header

Connector type: 2x4 8-pin header, 1.27mm pitch

Connector location: JP8

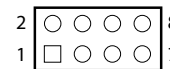

Pin	Definition	Pin	Definition
1	5VSB_PS2	2	5VSB_PS2
3	KDAT	4	MDAT
5	KCLK	6	MCLK
7	GND	8	GND

## Mini-PCIe Connector (WLAN/GSM)

Connector location: WIFI1

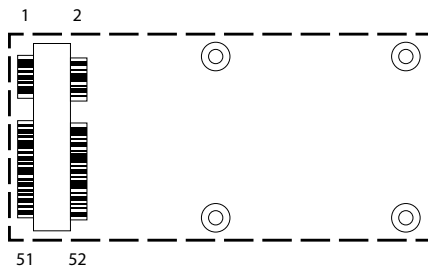

Pin	Definition	Pin	Definition
1	WAKE_N	2	3VSB_MINI1
3	NC	4	GND
5	NC	6	1V5_MINI1
7	MINICARD1CLKREQ#	8	UIM_PWR
9	GND	10	UIM_DATA
11	CLK_WIFI_N_C	12	UIM_CLK
13	CLK_WIFI_P_C	14	UIM_RESET
15	GND	16	UIM_VPP
17	NC	18	GND
19	NC	20	MINICARD1DIS#
21	GND	22	RST_MINIPCI1
23	PCIE_RN3_WIFI_C	24	3VSB_MINI1
25	PCIE_RP3_WIFI_C	26	GND

Pin	Definition	Pin	Definition
27	GND	28	1V5_MINI1
29	GND	30	SMB_CLK
31	PCH_WIFI_TXN4	32	SMB_DAT
33	PCH_WIFI_TXP4	34	GND
35	GND	36	USB2N6_C
37	GND	38	USB2P6_C
39	3VSB_MINI1	40	GND
41	3VSB_MINI1	42	NA
43	GND	44	NA
45	CL_CLK_C	46	NC
47	CL_DAT_C	48	1V5_MINI1
49	CL_RST#_C	50	GND
51	NC	52	3VSB_MINI2

## Mini-PCIe/mSATA Connector

Connector location: MINI1

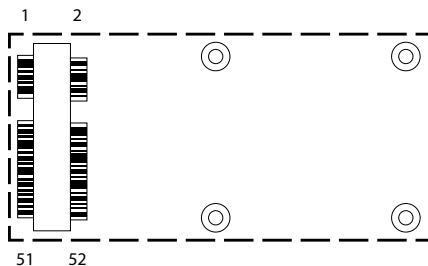

Pin	Definition	Pin	Definition
1	WAKE_N	2	3VSB_MINI2
3	NC	4	GND
5	NC	6	1V5_MINI2
7	MINICARD2CLKREQ#	8	NC
9	GND	10	NC
11	CLK_MINI_N_C	12	NC
13	CLK_MINI_P_C	14	NC
15	GND	16	NC
17	NC	18	GND
19	NC	20	MINICARD2DIS#
21	GND	22	RST_MINIPCIE2
23	PCIE_mSATA_RXP_C_C	24	3VSB_MINI2
25	PCIE_mSATA_RXN_C	26	GND

Pin	Definition	Pin	Definition
27	GND	28	1V5_MINI2
29	GND	30	SMB_CLK
31	PCIE_mSATA_TXN_C	32	SMB_DAT
33	PCIE_mSATA_TXP_C	34	GND
35	GND	36	USB2N7_C
37	GND	38	USB2P7_C
39	3VSB_MINI2	40	GND
41	3VSB_MINI2	42	NC
43	GND	44	NC
45	NC	46	NC
47	NC	48	1V5_MINI2
49	NC	50	GND
51	PCIE_mSATA_SEL_51	52	3VSB_MINI2

## PCIe x16 Slot

Connector type: PCIe x16 Slot

Connector location: PCIE1



Pin	Definition	Pin	Definition
A1	PCIE_PRSENT1	B1	VCC12
A2	VCC12	B2	VCC12
A3	VCC12	B3	VCC12
A4	GND	B4	GND
A5	PCIEX16_TCK	B5	PCIE_SMCLK
A6	PCIEX16_TDI	B6	PCIE_SMDAT
A7	NC	B7	GND
A8	PCIEX16_TMS	B8	VCC3
A9	VCC3	B9	PCIEX16_TRST#
A10	VCC3	B10	3VSB
A11	RST_PCIEX16	B11	3VSB
A12	GND	B12	NC
A13	CLK_PEG_A_P	B13	GND
A14	CLK_PEG_A_N	B14	PEG_TXP0_C
A15	GND	B15	PEG_TXN0_C
A16	PEG_RXP0	B16	GND
A17	PEG_RXN0	B17	PRSENT2#_1_C
A18	GND	B18	GND

Pin	Definition	Pin	Definition
A19	NC	B19	PEG_TXP1_C
A20	GND	B20	PEG_TXN1_C
A21	PEG_RXP1	B21	GND
A22	PEG_RXN1	B22	GND
A23	GND	B23	PEG_TXP2_C
A24	GND	B24	PEG_TXN2_C
A25	PEG_RXP2	B25	GND
A26	PEG_RXN2	B26	GND
A27	GND	B27	PEG_TXP3_C
A28	GND	B28	PEG_TXN3_C
A29	PEG_RXP3	B29	GND
A30	PEG_RXN3	B30	NC
A31	GND	B31	NC
A32	NC	B32	GND
A33	NC	B33	PEG_TXP4_C
A34	GND	B34	PEG_TXN4_C
A35	PEG_RXP4	B35	GND
A36	PEG_RXN4	B36	GND

Pin	Definition	Pin	Definition
A37	GND	B37	PEG_TXP5_C
A38	GND	B38	PEG_TXN5_C
A39	PEG_RXP5	B39	GND
A40	PEG_RXN5	B40	GND
A41	GND	B41	PEG_TXP6_C
A42	GND	B42	PEG_TXN6_C
A43	PEG_RXP6	B43	GND
A44	PEG_RXN6	B44	GND
A45	GND	B45	PEG_TXP7_C
A46	GND	B46	PEG_TXN7_C
A47	PEG_RXP7	B47	GND
A48	PEG_RXN7	B48	NC
A49	GND	B49	GND
A50	NC	B50	PEG_TXP8_C
A51	GND	B51	PEG_TXN8_C
A52	PEG_RXP8	B52	GND
A53	PEG_RXN8	B53	GND
A54	GND	B54	PEG_TXP9_C
A55	GND	B55	PEG_TXN9_C
A56	PEG_RXP9	B56	GND
A57	PEG_RXN9	B57	GND
A58	GND	B58	PEG_TXP10_C
A59	GND	B59	PEG_TXN10_C

Pin	Definition	Pin	Definition
A60	PEG_RXP10	B60	GND
A61	PEG_RXN10	B61	GND
A62	GND	B62	PEG_TXP11_C
A63	GND	B63	PEG_TXN11_C
A64	PEG_RXP11	B64	GND
A65	PEG_RXN11	B65	GND
A66	GND	B66	PEG_TXP12_C
A67	GND	B67	PEG_TXN12_C
A68	PEG_RXP12	B68	GND
A69	PEG_RXN12	B69	GND
A70	GND	B70	PEG_TXP13_C
A71	GND	B71	PEG_TXN13_C
A72	PEG_RXP13	B72	GND
A73	PEG_RXN13	B73	GND
A74	GND	B74	PEG_TXP14_C
A75	GND	B75	PEG_TXN14_C
A76	PEG_RXP14	B76	GND
A77	PEG_RXN14	B77	GND
A78	GND	B78	PEG_TXP15_C
A79	GND	B79	PEG_TXN15_C
A80	PEG_RXP15	B80	GND
A81	PEG_RXN15	B81	NC
A82	GND	B82	NC

# CHAPTER 3: SYSTEM SETUP

## Installing a CPU

1. Remove the 4 flat screws on the top cover.



2. Lift up the cover and remove it from the chassis.



3. Remove the mounting screws that secure the heat sink to the chassis.

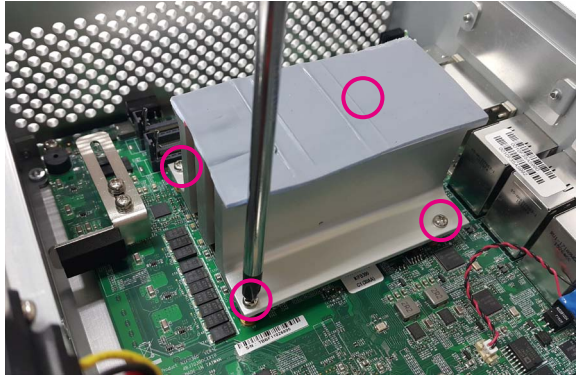

4. The CPU socket is readily accessible after you have removed the heat sink.

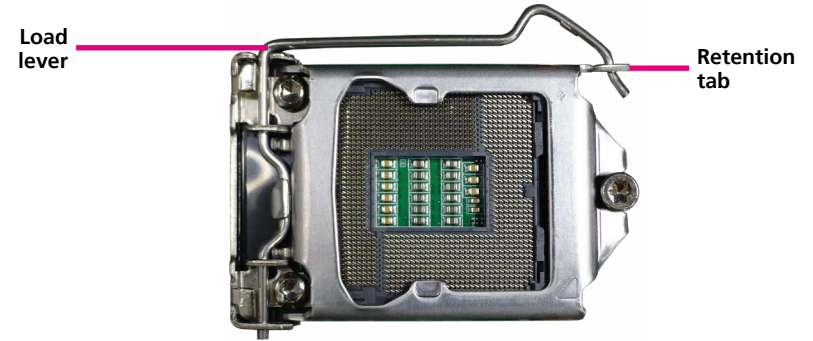

5. Unlock the socket by pushing the load lever down, moving it sideways until it is released from the retention tab; then lift the load lever up.

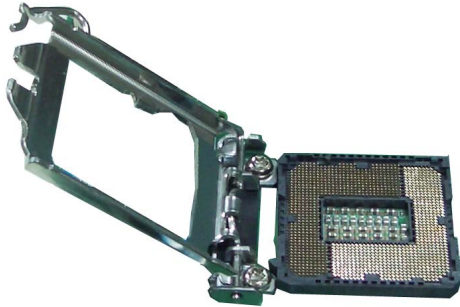

6. Insert the CPU into the socket. The triangular edge on the CPU must align with the corner of the CPU socket shown on the photo.

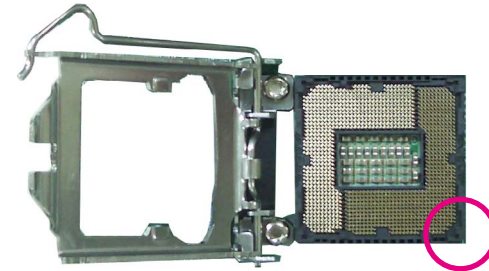

The CPU's notch will at the same time fit into the socket's alignment key.

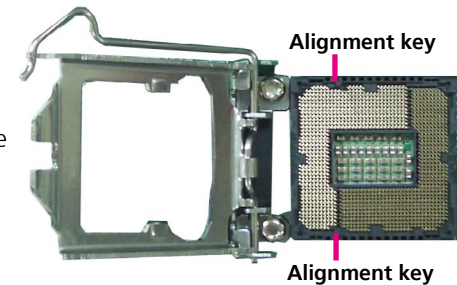

- Handle the CPU by its edges and avoid touching the pins.
- The CPU will fit in only one orientation and can easily be inserted without exerting any force.



7. Close the load plate and then hook the load lever under the retention tab.



8. Apply thermal paste on top of the CPU.



Do not force the CPU into the socket. Forcing the CPU into the socket may bend the pins and damage the CPU.

9. Tighten the screws to secure the heat sink in place.

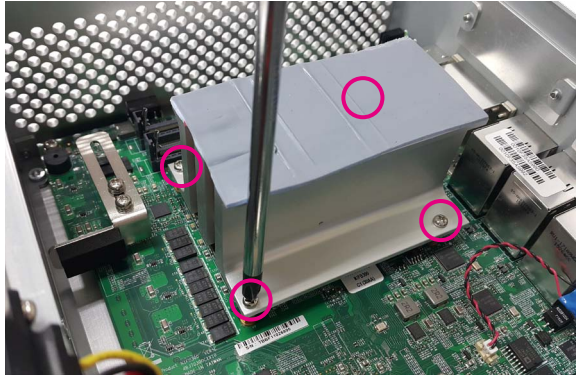

## Installing a SO-DIMM Memory Module

1. Remove the chassis before installing a SO-DIMM module.

2. Locate the SO-DIMM memory sockets.

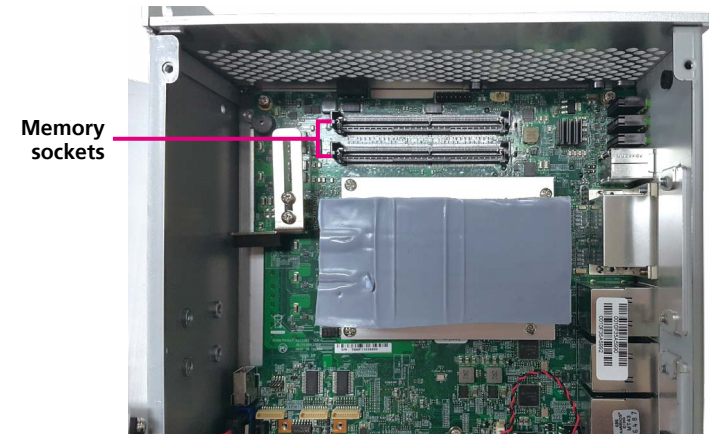

3. Insert the memory module into the socket.

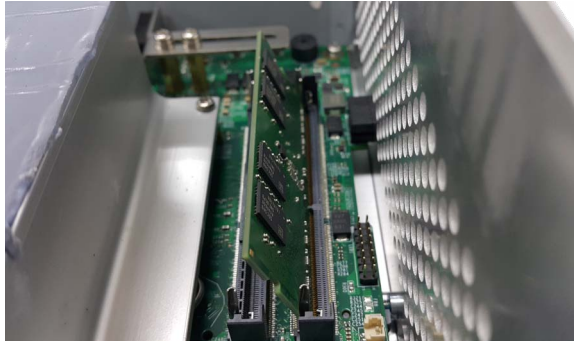

4. Apply even pressure to both ends of the module until it is locked by the latches.



5. Ensure the memory module is installed straight.



6. Insert another SO-DIMM module into the socket and apply even pressure to both ends of the module until it is locked by the latches.



## Installing a SIM Card

1. Locate the mini-PCIe slot and remove the bracket first.

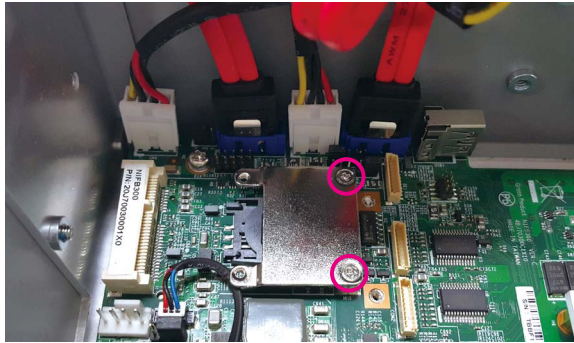

2. Locate the SIM card holder.

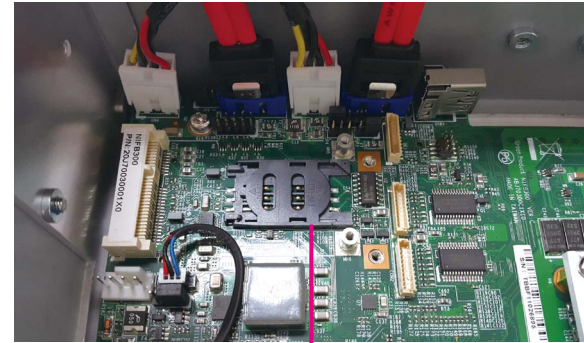

SIM card holder



3. Release the SIM card cover and place the SIM card into the holder.



4. Close the cover and secure the SIM card into position.

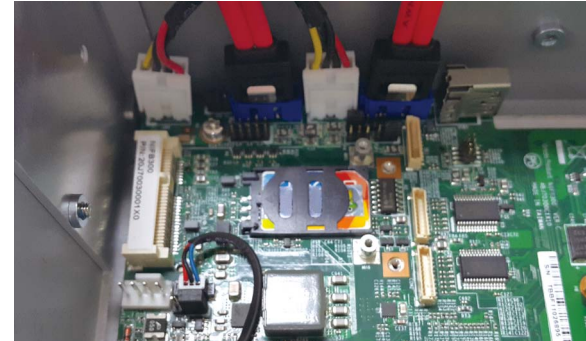

## Installing a CFast Card

1. Locate the CFast socket on the top cover.

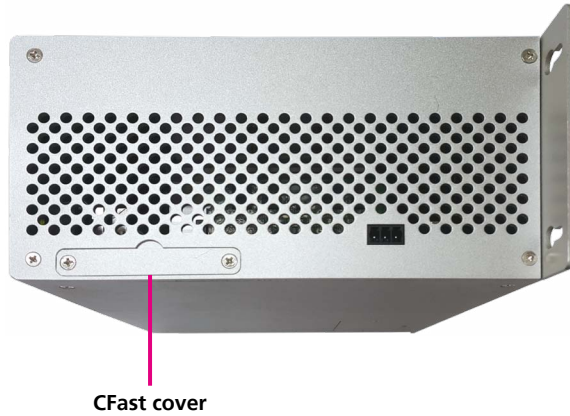

2. Remove the cover of the CFast socket.





3. Insert the CFast card into the socket.



4. Ensure the CFast card is installed and engaged firmly with a click sound.



## Installing a 3G/GSM Module

1. Install the 3G/GSM module into the 3G/GSM slot.

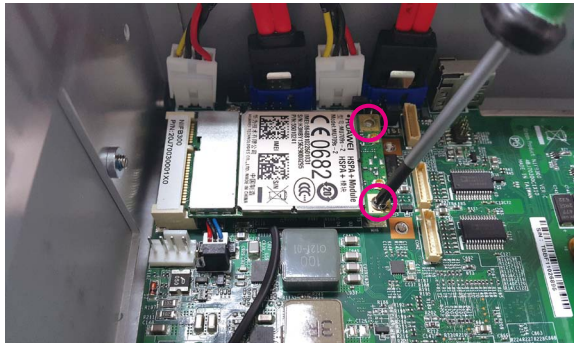

2. Fix the antenna cable to the 3G/GSM module.

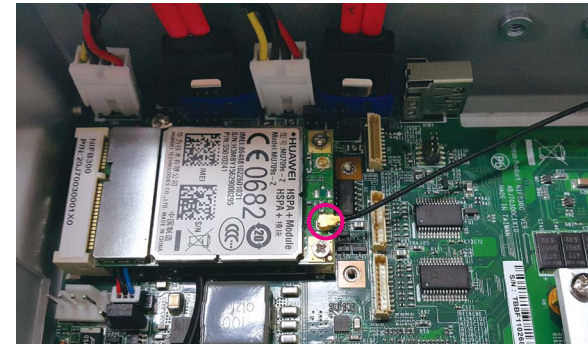

3. Locate the antenna hole on the front panel, and insert the antenna jack through the hole.

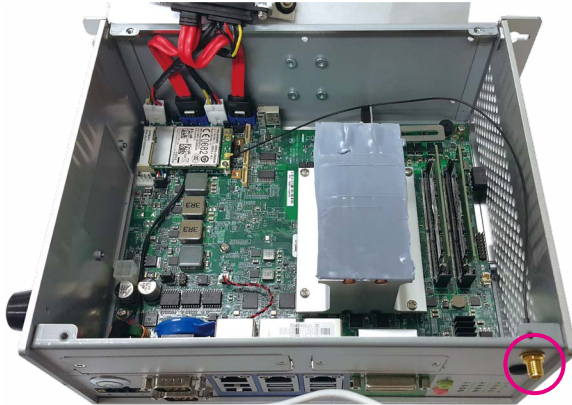

4. Fix the antenna jack with rings.



5. Install the antenna.



## Installing an mSATA Module (NIFE 300 Only)



The following instructions apply to NIFE 300 only.

1. Remove the mini-PCIe cover on the side panel.

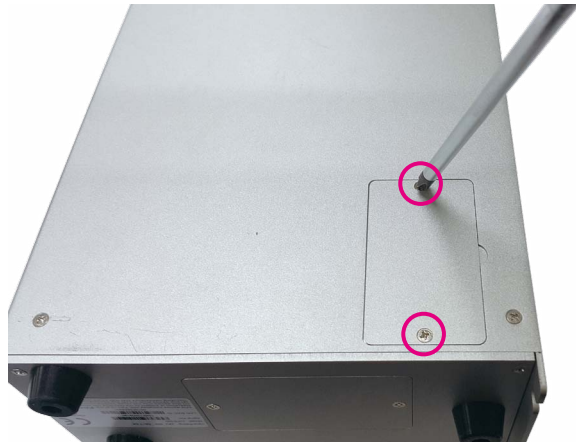

2. Locate the mini-PCIe socket, then install and fix the mSATA module into the socket.

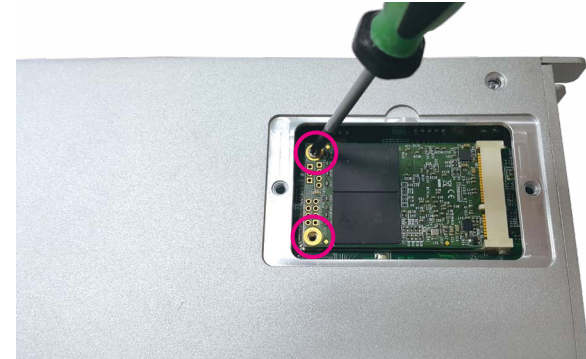

3. Ensure both screws are fixed tightly to the socket.



## Installing an mSATA Module (NIFE 300P2/P3/P2E/E16/E3)



The following instructions apply to NIFE 300P2/P2E/E16/P3/E3.

1. Remove the side panel.

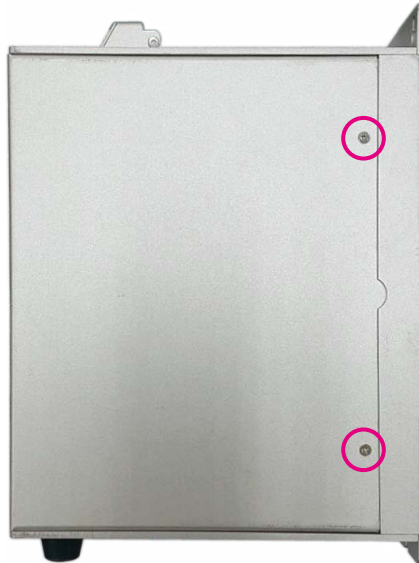

2. Locate the mini-PCIe socket, then install and fix the mSATA module into the socket.

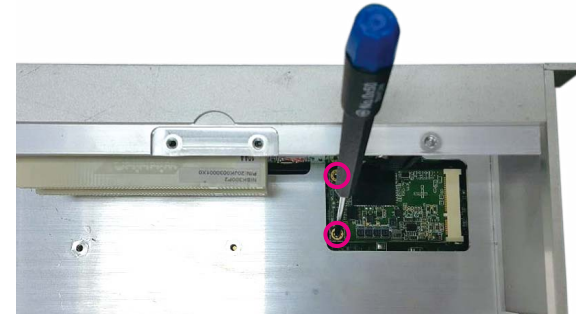

3. Ensure both screws are fixed tightly to the socket.

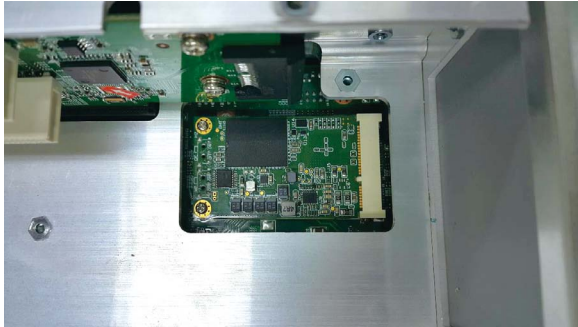



## Installing an External SATA Hard Drive

1. Remove the external HDD cover.

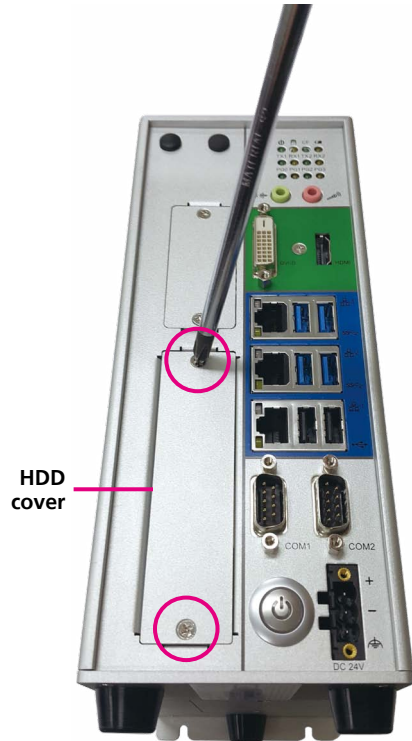

2. Pull out the HDD bracket and place the HDD into the bracket.



3. Fix the HDD onto the HDD bracket from the bottom side using screws.

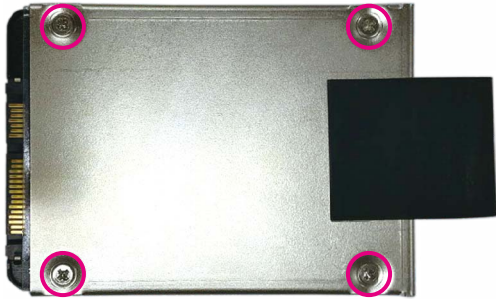

4. Install the HDD bracket into the external HDD drive bay, and secure the external HDD cover back to the drive bay.



## Installing an Internal SATA Hard Drive

1. Remove the chassis cover.



2. Locate the internal HDD bracket.

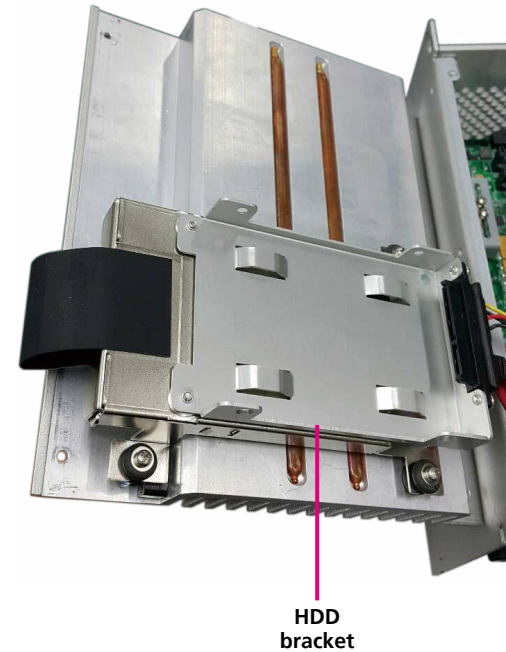

3. Install and fix the HDD to the internal HDD bracket.

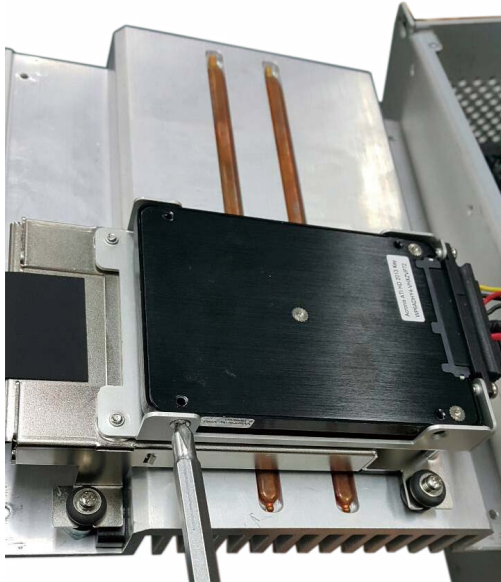

## Installing a PCI or PCIe Card



The following instructions apply to NIFE 300P2/P2E/E16/P3/E3, and does not apply to NIFE 300.

1. Remove the side panel.

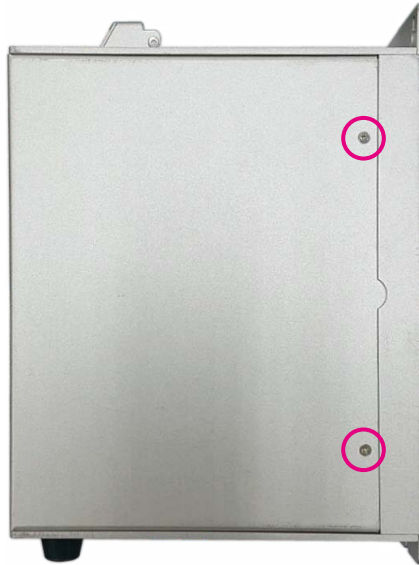

2. Locate and remove the screw on the PCI/PCIe bracket cover.

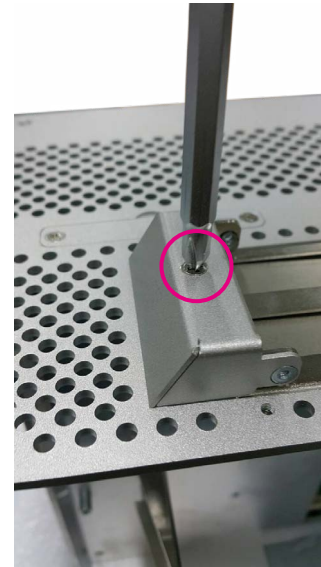

3. Remove the plastic screw holder if the height of the PCI/PCle card is sufficient.



4. Install the PCI/PCle card into the slot.

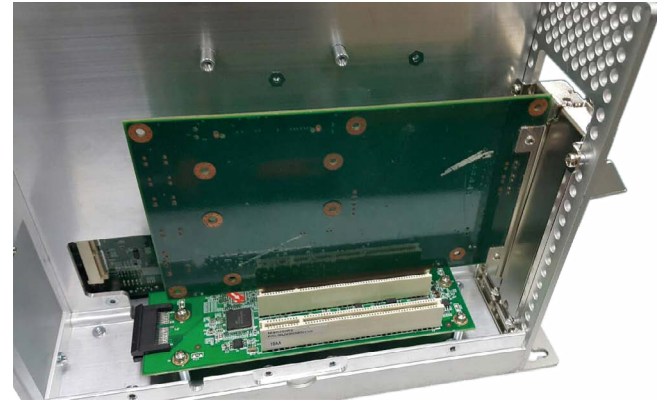

- Fix the screw on the PCI/PCIe cover, and close the bracket cover for the PCI/PCIe expansion.

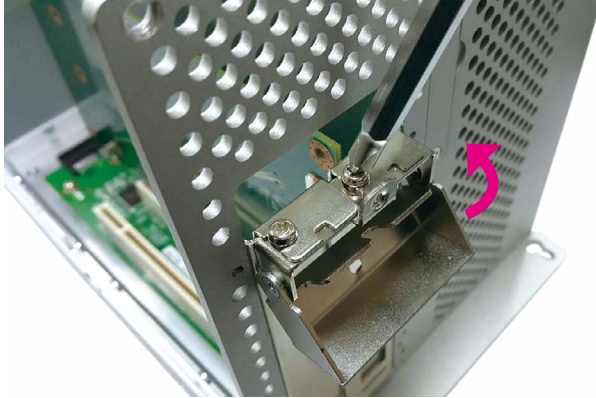

## PCI Volts Configuration on NIFE 300 Riser Cards

The PCI Volts is configured to 5V as default on all NIFE 300 riser cards.

Model	Riser Configuration	Riser Jumper Location	Default Volts Setting
NIFE 300P2	2x PCI Slots	JP3 2-3(5V), 1-1(3.3V)	2-3
NIFE 300P2E	1x PCI Slot and 1x PCIe Slot	JP2 2-3(5V), 1-1(3.3V)	2-3
NIFE 300P3	2x PCI Slots and 1x PCIe Slot	JP3 2-3(5V), 1-1(3.3V)	2-3

## Wallmount Mounting



The main mounting method of the NIFE 300 series is wallmount. Please locate the wallmount fixing holes at the rear of the NIFE 300 series for wallmount mounting.

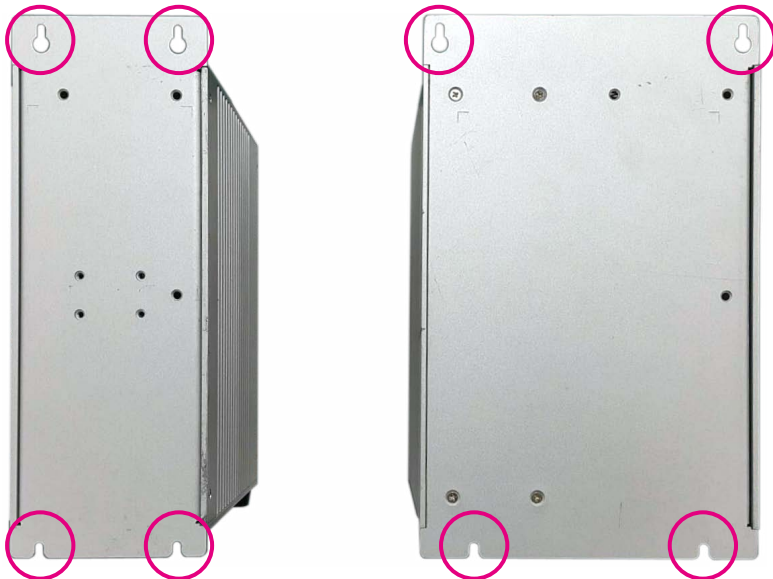



## CHAPTER 4: BIOS SETUP

This chapter describes how to use the BIOS setup program for the NIFE 300 series. The BIOS screens provided in this chapter are for reference only and may change if the BIOS is updated in the future.

To check for the latest updates and revisions, visit the NEXCOM website at [www.nexcom.com.tw](http://www.nexcom.com.tw).

### About BIOS Setup

The BIOS (Basic Input and Output System) Setup program is a menu driven utility that enables you to make changes to the system configuration and tailor your system to suit your individual work needs. It is a ROM-based configuration utility that displays the system's configuration status and provides you with a tool to set system parameters.

These parameters are stored in non-volatile battery-backed-up CMOS RAM that saves this information even when the power is turned off. When the system is turned back on, the system is configured with the values found in CMOS.

With easy-to-use pull down menus, you can configure items such as:

- Hard drives, diskette drives, and peripherals
- Video display type and display options
- Password protection from unauthorized use
- Power management features

The settings made in the setup program affect how the computer performs. It is important, therefore, first to try to understand all the setup options, and second, to make settings appropriate for the way you use the computer.

### When to Configure the BIOS

- This program should be executed under the following conditions:
  - When changing the system configuration
  - When a configuration error is detected by the system and you are prompted to make changes to the setup program
  - When resetting the system clock
  - When redefining the communication ports to prevent any conflicts
  - When making changes to the Power Management configuration
  - When changing the password or making other changes to the security setup

Normally, CMOS setup is needed when the system hardware is not consistent with the information contained in the CMOS RAM, whenever the CMOS RAM has lost power, or the system features need to be changed.

## Default Configuration

Most of the configuration settings are either predefined according to the Load Optimal Defaults settings which are stored in the BIOS or are automatically detected and configured without requiring any actions. There are a few settings that you may need to change depending on your system configuration.

## Entering Setup











When the system is powered on, the BIOS will enter the Power-On Self Test (POST) routines. These routines perform various diagnostic checks; if an error is encountered, the error will be reported in one of two different ways:

- If the error occurs before the display device is initialized, a series of beeps will be transmitted.
- If the error occurs after the display device is initialized, the screen will display the error message.

Powering on the computer and immediately pressing <Del> allows you to enter Setup.

Press the  key to enter Setup:

## Legends

Key	Function
	Moves the highlight left or right to select a menu.
	Moves the highlight up or down between sub-menus or fields.
	Exits the BIOS Setup Utility.
	Scrolls forward through the values or options of the highlighted field.
	Scrolls backward through the values or options of the highlighted field.
	Selects a field.
	Displays General Help.
	Load previous values.
	Load optimized default values.
	Saves and exits the Setup program.
	Press <Enter> to enter the highlighted sub-menu

## Scroll Bar

When a scroll bar appears to the right of the setup screen, it indicates that there are more available fields not shown on the screen. Use the up and down arrow keys to scroll through all the available fields.

## Submenu

When “▶” appears on the left of a particular field, it indicates that a submenu which contains additional options are available for that field. To display the submenu, move the highlight to that field and press  .

## BIOS Setup Utility

Once you enter the AMI BIOS Setup Utility, the Main Menu will appear on the screen. The main menu allows you to select from several setup functions and one exit. Use arrow keys to select among the items and press  to accept or enter the submenu.

### Main

The Main menu is the first screen that you will see when you enter the BIOS Setup Utility.

### System Language

Configures the default language of the system.

### System Date

The date format is <day>, <month>, <date>, <year>. Day displays a day, from Monday to Sunday. Month displays the month, from January to December. Date displays the date, from 1 to 31. Year displays the year, from 1999 to 2099.

### System Time

The time format is <hour>, <minute>, <second>. The time is based on the 24-hour military-time clock. For example, 1 p.m. is 13:00:00. Hour displays hours from 00 to 23. Minute displays minutes from 00 to 59. Second displays seconds from 00 to 59.

## Advanced

The Advanced menu allows you to configure your system for basic operation. Some entries are defaults required by the system board, while others, if enabled, will improve the performance of your system or let you set some features according to your preference.



Setting incorrect field values may cause the system to malfunction.



## IT8786 Super IO Configuration

This section is used to configure the serial ports.

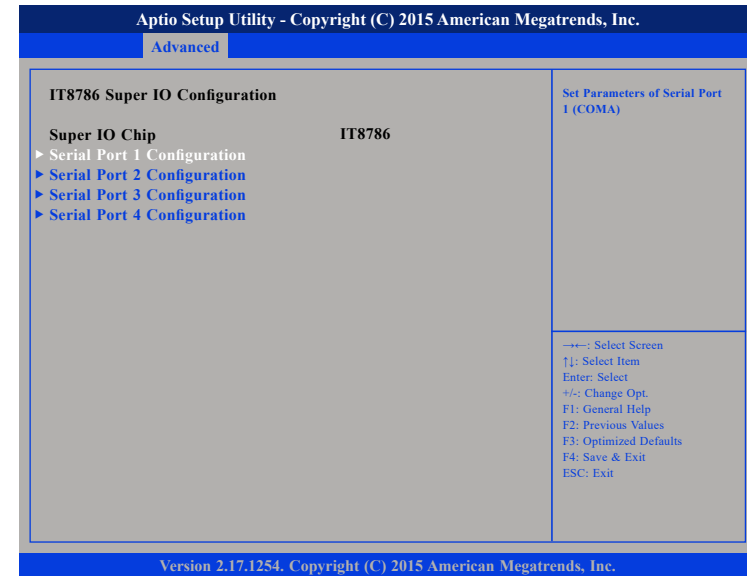

### Super IO Chip

Displays the Super I/O chip used on the board.

## Serial Port 1 Configuration

This section is used to configure serial port 1.



### Serial Port

Enables or disables the serial port.

### Onboard Serial Port Mode

Select this to change the serial port mode to RS232, RS422, RS485 or RS485 Auto.

### Terminal Resistor

Enables or disables the terminal resistor.

## Serial Port 2 Configuration

This section is used to configure serial port 2.

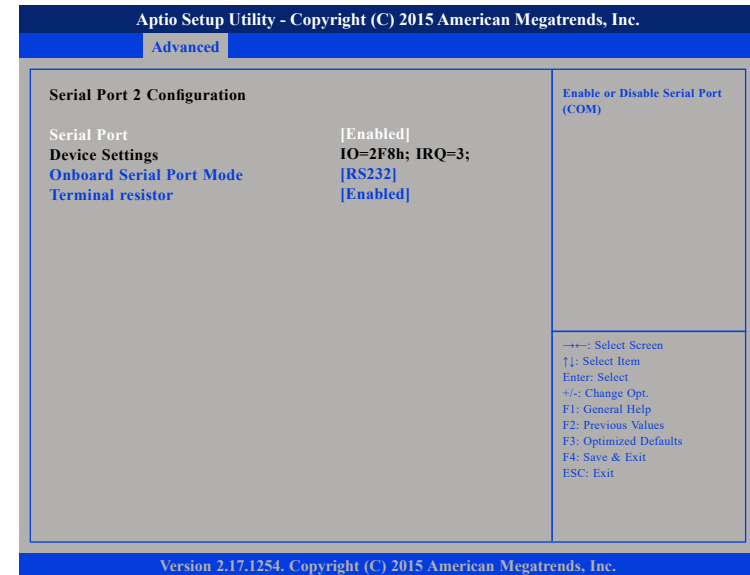

### Serial Port

Enables or disables the serial port.

### Onboard Serial Port Mode

Select this to change the serial port mode to RS232, RS422, RS485 or RS485 Auto.

### Terminal Resistor

Enables or disables the terminal resistor.

### Serial Port 3 Configuration

This section is used to configure serial port 3.



#### Serial Port

Enables or disables the serial port.

### Serial Port 4 Configuration

This section is used to configure serial port 4.

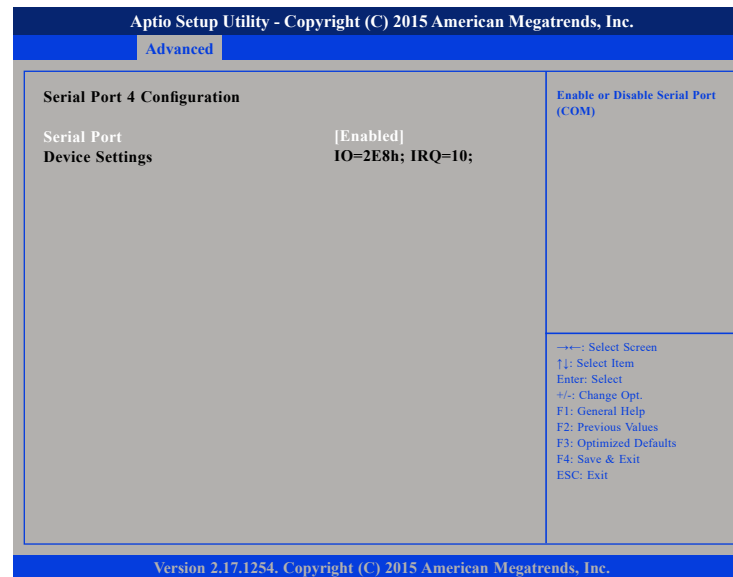

#### Serial Port

Enables or disables the serial port.

## Hardware Monitor

This section is used to monitor hardware status such as temperature, fan speed and voltages.

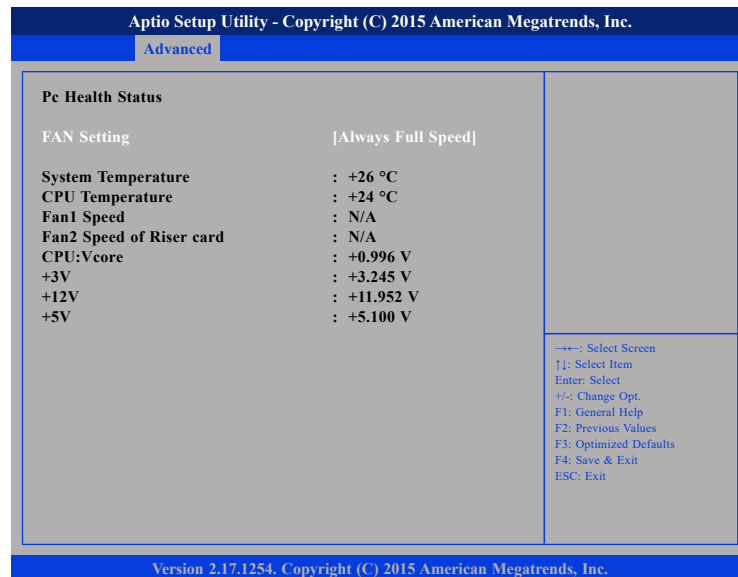

### Fan1 Speed

Detects and displays fan1 speed.

### Fan2 Speed

Detects and displays fan2 speed of the riser card.

### VCore

Detects and displays the Vcore CPU voltage.

### +3V

Detects and displays 3.3V voltage.

### +12V

Detects and displays 12V voltage.

### +5V

Detects and displays 5V voltage.

### FAN Setting

Configures the speed of the fan, the options are Always Full Speed, Enable Smart Fan and Disable.

### System Temperature

Detects and displays the current system temperature.

### CPU Temperature

Detects and displays the current CPU temperature.



## CPU Configuration

This section is used to configure the CPU.

Aptio Setup Utility - Copyright (C) 2015 American Megatrends, Inc.

Advanced

CPU Configuration		Enabled for Windows XP and Linux (OS optimized for HyperThreading Technology) and Disabled for other OS (OS not optimized for Hyper-Threading Technology). When Disabled only one thread per enabled core is enabled.
Intel(R) Core(TM) i7-6700TE CPU @ 2.40GHz		
CPU Signature	506E3	
Microcode Patch	33	
Max CPU Speed	2400 MHz	
Min CPU Speed	800 MHz	
CPU Speed	2400 MHz	
Processor Cores	4	
Hyper Threading Technology	Supported	
Intel VT-x Technology	Supported	
Intel SMX Technology	Supported	
64-bit	Supported	
EIST Technology	Supported	
CPU C3 state	Supported	
CPU C6 state	Supported	
CPU C7 state	Supported	
L1 Data Cache	32 kB x 4	
L1 Code Cache	32 kB x 4	
L2 Cache	256 kB x 4	
L3 Cache	8 MB	
L4 Cache	Not Present	
Hyper-threading	[Enabled]	

---: Select Screen  
↑↓: Select Item  
Enter: Select  
+/-: Change Opt.  
F1: General Help  
F2: Previous Values  
F3: Optimized Defaults  
F4: Save & Exit  
ESC: Exit

Version 2.17.1254. Copyright (C) 2015 American Megatrends, Inc.

### Hyper-threading

Enables or disables hyper-threading technology.

### Active Processor Cores

Select the number of cores to enable in each processor package.

### Intel® Virtualization Technology

Enables or disables Intel Virtualization technology. When enabled, a VMM can utilize the additional hardware capabilities provided by Vanderpool Technology.

Aptio Setup Utility - Copyright (C) 2015 American Megatrends, Inc.

Advanced

		Enable or disable CPU C states
Microcode Patch	33	
Max CPU Speed	2400 MHz	
Min CPU Speed	800 MHz	
CPU Speed	2400 MHz	
Processor Cores	4	
Hyper Threading Technology	Supported	
Intel VT-x Technology	Supported	
Intel SMX Technology	Supported	
64-bit	Supported	
EIST Technology	Supported	
CPU C3 state	Supported	
CPU C6 state	Supported	
CPU C7 state	Supported	
L1 Data Cache	32 kB x 4	
L1 Code Cache	32 kB x 4	
L2 Cache	256 kB x 4	
L3 Cache	8 MB	
L4 Cache	Not Present	
Hyper-threading	[Enabled]	
Active Processor Cores	[All]	
Intel Virtualization Technology	[Enabled]	
Intel(R) SpeedStep(tm)	[Disabled]	
CPU C states	[Disabled]	

---: Select Screen  
↑↓: Select Item  
Enter: Select  
+/-: Change Opt.  
F1: General Help  
F2: Previous Values  
F3: Optimized Defaults  
F4: Save & Exit  
ESC: Exit

Version 2.17.1254. Copyright (C) 2015 American Megatrends, Inc.

### Intel® SpeedStep™

Enables or disables Intel SpeedStep.

### CPU C States

Enables or disables CPU C States support.

## SATA Configuration

This section is used to configure the SATA drives.

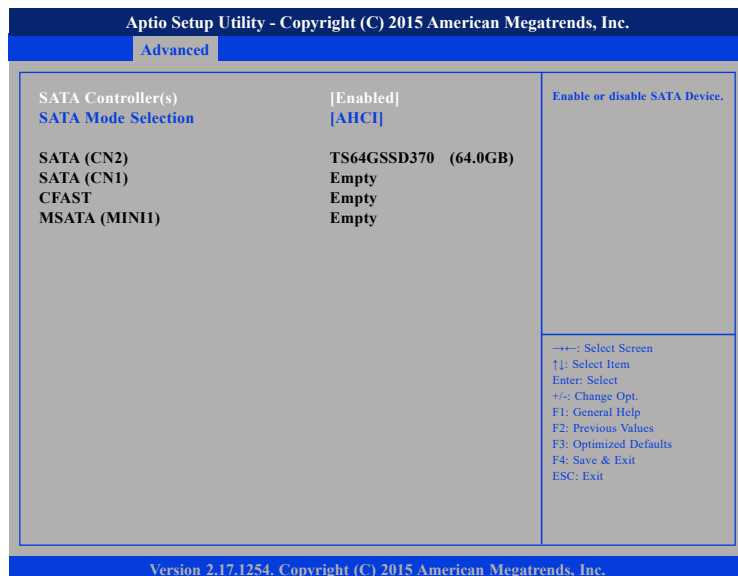

### SATA Controller(s)

Enables or disables the SATA controller.

### SATA Mode Selection

Configures the SATA mode.

**AHCI** This option configures the Serial ATA drives to use AHCI (Advanced Host Controller Interface). AHCI allows the storage driver to enable the advanced Serial ATA features which will increase storage performance.

**RAID** This option allows you to create RAID or Intel Matrix Storage configuration on Serial ATA devices.

## CSM Configuration

This section is used to configure the compatibility support module features.

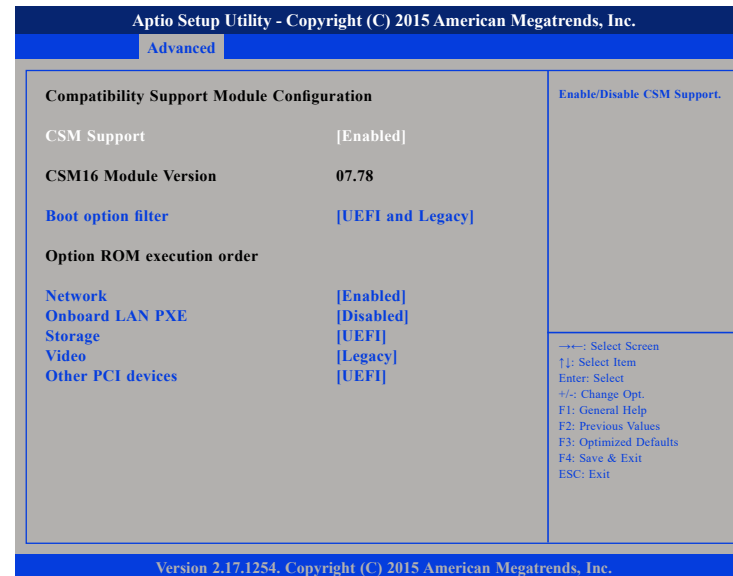

### CSM Support

Enables or disables CSM support.

### Boot Option Filter

Configures which devices the system will boot from.

### Network

Enables or disables the boot option for legacy network devices.

### Onboard LAN PXE

Enables or disables onboard LAN PXE ROM.

## Storage

Enables or disables the boot option for legacy storage devices.

## Video

Enables or disables the boot option for legacy video devices.

## Other PCI Devices

Determines OpROM execution policy for devices other than network, storage or video.

## USB Configuration

This section is used to configure the USB.

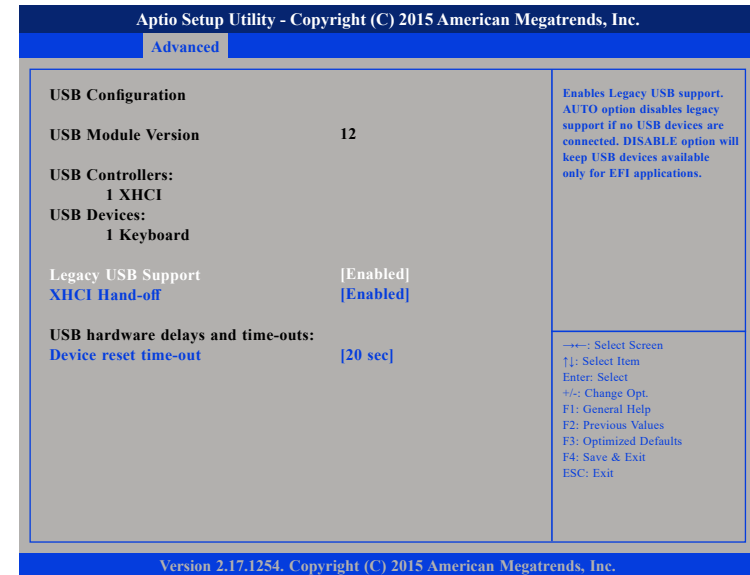

### Legacy USB Support

Enabled Enables Legacy USB.

Auto Disables support for Legacy when no USB devices are connected.

Disabled Keeps USB devices available only for EFI applications.

### XHCI Hand-off

This is a workaround for OSs that does not support XHCI hand-off. The XHCI ownership change should be claimed by the XHCI driver respectively.

### Device reset time-out

Selects the USB mass storage device start unit command timeout.

## Chipset

This section is used to configure the system based on the specific features of the chipset.

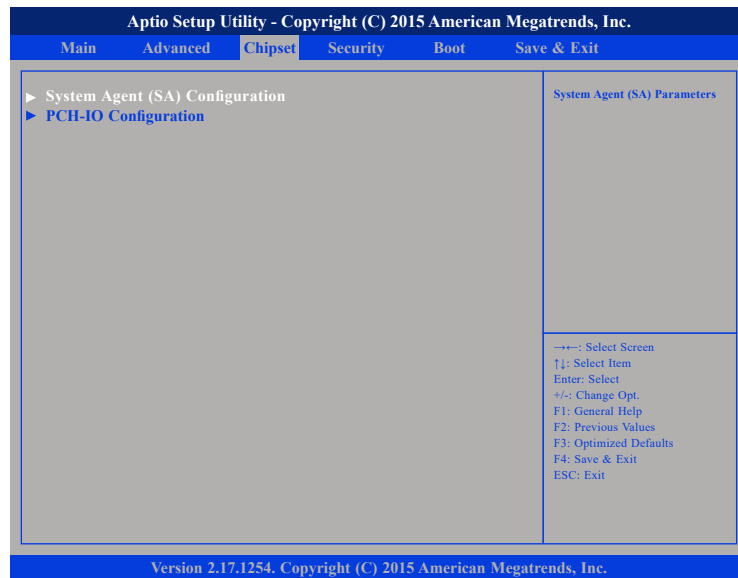

Setting incorrect field values may cause the system to malfunction.

## System Agent (SA) Configuration



### VT-d

Enables or disables VT-d function on MCH.

### Graphics Configuration

Enters the graphics chip settings sub-menu.

### PEG Port Configuration

Enters the PEG port settings sub-menu.

### Memory Configuration

Enters the memory settings sub-menu.

## Graphics Configuration



### Primary Display

Select which of IGFX/PEG/PCI graphics device should be primary display or select SG for switchable GFX.

### Primary PEG

Select which PEG device should be the primary PEG.

### Primary PCIE

Select which PCIE device should be the primary PCIE.

### Internal Graphics

Keep IGD enabled based on the setup options.

### DVMT Total Gfx Mem

Select DVMT5.0 Total Graphic Memory size used by the internal graphics device.

## LCD Control



### Primary IGFX Boot Display

Select the video device which will be activated during POST. This has no effect if external graphics is present. Secondary boot display selection will appear based on your selection. VGA modes will be supported only on primary display.

### Secondary IGFX Boot Display

Select the secondary display device.

### LCD Panel Type

Select the LCD panel used by the internal graphics device by selecting the appropriate setup item.

### Panel Scaling

Select the LCD panel scaling option used by the internal graphics device.

### Backlight Control

Select the backlight control mode.

### BIA

The options are Auto, Disabled and Level 1 to Level 5.

### Spread Spectrum Clock Chip

Select how the spread spectrum clock is controlled.

Hardware	Controlled by the chip.
Software	Controlled by the BIOS.

### Active LFP

Select the Active LFP configuration.

No LVDS	VBIOS does not enable LVDS.
eDP Port-A	LFP driven by Int-DisplayPort encoder from Port-A

### Panel Color Depth

Select the LFP panel color depth.

## PEG Port Configuration

Aptio Setup Utility - Copyright (C) 2015 American Megatrends, Inc.	
Chipset	
<b>PEG Port Configuration</b>	
Enable or Disable the Root Port	
<b>PEG 0:1:0</b>	<b>Not Present</b>
Enable Root Port	[Enabled]
Max Link Speed	[Auto]
<b>PEG 0:1:1</b>	<b>Not Present</b>
Enable Root Port	[Enabled]
Max Link Speed	[Auto]
→←: Select Screen ↑↓: Select Item Enter: Select +/-: Change Opt. F1: General Help F2: Previous Values F3: Optimized Defaults F4: Save & Exit ESC: Exit	
Version 2.17.1254. Copyright (C) 2015 American Megatrends, Inc.	

### Enable Root Port

Enables or disables the root port.

### Max Link Speed

Select the maximum link speed of the PEG device.

## Memory Configuration

Aptio Setup Utility - Copyright (C) 2015 American Megatrends, Inc.	
Chipset	
<b>Memory Configuration</b>	
<b>Memory RC Version</b>	1.5.0.0
<b>Memory Frequency</b>	2133 MHz
<b>Total Memory</b>	8192 MB
<b>VDD</b>	1200
<b>DIMM#1</b>	4096 MB
<b>DIMM#2</b>	4096 MB
<b>Memory Timings (tCL-tRCD-tRP-tRAS)</b>	15-36
→←: Select Screen ↑↓: Select Item Enter: Select +/-: Change Opt. F1: General Help F2: Previous Values F3: Optimized Defaults F4: Save & Exit ESC: Exit	
Version 2.17.1254. Copyright (C) 2015 American Megatrends, Inc.	

### Memory Configuration

Displays the information on the memory installed.

## Security

Aptio Setup Utility - Copyright (C) 2015 American Megatrends, Inc.					
Main	Advanced	Chipset	Security	Boot	Save & Exit
<p><b>Password Description</b></p> <p>If ONLY the Administrator's password is set, then this only limits access to Setup and is only asked for when entering Setup. If ONLY the User's password is set, then this is a power on password and must be entered to boot or enter Setup. In Setup the User Will have Administrator rights. The password length must be in the following range:</p> <p>Minimum length                   3 Maximum length                   20</p> <p>Administrator Password User Password</p>		<p>Set Administrator Password</p>			
		<p>→←: Select Screen ↑↓: Select Item Enter: Select +/-: Change Opt. F1: General Help F2: Previous Values F3: Optimized Defaults F4: Save &amp; Exit ESC: Exit</p>			
Version 2.17.1254. Copyright (C) 2015 American Megatrends, Inc.					

### Administrator Password

Select this to reconfigure the administrator's password.

### User Password

Select this to reconfigure the user's password.

## Boot

Aptio Setup Utility - Copyright (C) 2015 American Megatrends, Inc.					
Main	Advanced	Chipset	Security	Boot	Save & Exit
<p><b>Boot Configuration</b></p> <p>Setup Prompt Timeout                   1 Bootup NumLock State                   [On] Quiet Boot                                   [Disabled]</p> <p><b>Boot Option Priorities</b></p> <p>Boot Option #1                           [P0: TS64GSSD370     Fast Boot                                   [Disabled]</p> <p><b>Hard Drive BBS Priorities</b></p>		<p>Number of seconds to wait for setup activation key. 65535(0xFFFF) means indefinite waiting.</p>			
		<p>→←: Select Screen ↑↓: Select Item Enter: Select +/-: Change Opt. F1: General Help F2: Previous Values F3: Optimized Defaults F4: Save &amp; Exit ESC: Exit</p>			
Version 2.17.1254. Copyright (C) 2015 American Megatrends, Inc.					

### Setup Prompt Timeout

This section configures the number of seconds to wait for the setup activation key. 65535(0xFFFF) denotes indefinite waiting.

### Bootup NumLock State

This allows you to determine the default state of the numeric keypad. By default, the system boots up with NumLock on wherein the function of the numeric keypad is the number keys. When set to Off, the function of the numeric keypad is the arrow keys.



### Quiet Boot

Enabled Displays OEM logo instead of the POST messages.  
 Disabled Displays normal POST messages.

### Boot Option Priorities

Adjust the boot sequence of the system. Boot Option #1 is the first boot device that the system will boot from, next will be #2 and so forth.

### Fast Boot

Enables or disables fast boot technology to speed up the system boot time. This is achieved by skipping specific tests during BIOS POST routine.

### Hard Drive BBS Priorities

Sets the order of the legacy devices in this group.

## Save & Exit

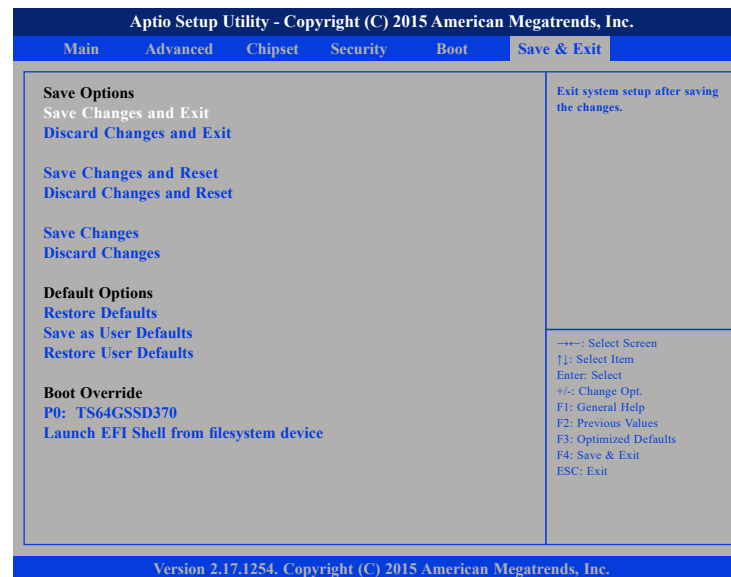

### Save Changes and Exit

To save the changes and exit the Setup utility, select this field then press <Enter>. A dialog box will appear. Confirm by selecting Yes. You can also press <F4> to save and exit Setup.

### Discard Changes and Exit

To exit the Setup utility without saving the changes, select this field then press <Enter>. You may be prompted to confirm again before exiting. You can also press <ESC> to exit without saving the changes.

### **Save Changes and Reset**

To save the changes and reset, select this field then press <Enter>. A dialog box will appear. Confirm by selecting Yes.

### **Discard Changes and Reset**

To exit the Setup utility without saving the changes, select this field then press <Enter>. You may be prompted to confirm again before exiting.

### **Save Changes**

To save changes and continue configuring the BIOS, select this field then press <Enter>. A dialog box will appear. Confirm by selecting Yes.

### **Discard Changes**

To discard the changes, select this field then press <Enter>. A dialog box will appear. Confirm by selecting Yes to discard all changes made and restore the previously saved settings.

### **Restore Defaults**

To restore the BIOS to default settings, select this field then press <Enter>. A dialog box will appear. Confirm by selecting Yes.

### **Save as User Defaults**

To use the current configurations as user default settings for the BIOS, select this field then press <Enter>. A dialog box will appear. Confirm by selecting Yes.

### **Restore User Defaults**

To restore the BIOS to user default settings, select this field then press <Enter>. A dialog box will appear. Confirm by selecting Yes.

### **Boot Override**

To bypass the boot sequence from the Boot Option List and boot from a particular device, select the desired device and press <Enter>.

### **Launch EFI Shell From Filesystem Device**

Launches the EFI shell.

# APPENDIX A: POWER CONSUMPTION

## Power Consumption Management

### Purpose

The purpose of the power consumption test is to verify the power dissipation of system, and the loading of power supply.

### Test Equipment

PROVA CM-07 AC/DC CLAMP METER

### Device Under Test

DUT: sys#1/

### Test Procedure

1. Power up the DUT, boot into Windows 7 x32 Professional.
2. Entering standby mode (HDD power down).
3. Measure the power consumption and record it.
4. Run Burn-in test program to apply 100% full loading.
5. Measure the power consumption and record it.

### Test Data

	Sys #1
	+24V
Full-Loading Mode	2.1A
Total	50.4W
Standby S3 Mode	0.4A
Total	9.8W

# APPENDIX B: WATCHDOG PROGRAMMING GUIDE

## ITE8786E WatchDog Programming Guide

```
#define Superio_Port    0x2E
#define Superio_LDN    0x07
```

```
/*Enter the MB PnP mode with 0x87, 0x01, 0x55, 0x55
```

```
outportb(Superio_Port, 0x87);
```

```
outportb(Superio_Port, 0x01);
```

```
outportb(Superio_Port, 0x55);
```

```
outportb(Superio_Port, 0x55);
```

```
/*Set LDN=0x07 point to the WDT function
```

```
outportb(Superio_Port, Superio_LDN);
```

```
outportb(Superio_Port+1, 0x07);
```

```
/*Setup configuration register 0x72, if set 90h is second, set 10h is minute (WDT output through PWRGD)
```

```
outportb(Superio_Port, 0x72);
```

```
outportb(Superio_Port+1, 0x90);
```

```
/*Setup WDT time-out value. this demo code is used to program the time-out value with 4 sec.
```

```
outportb(Superio_Port, 0x73);
```

```
outportb(Superio_Port+1, 0x04);
```

```
/*Exit the MB PnP Mode
```

```
outportb(Superio_Port, 0x02);
```

```
outportb(Superio_Port+1, 0x02);
```

# APPENDIX C: GPIO PROGRAMMING GUIDE

GPIO (General Purpose Input/Output) pins are provided for custom system design. This appendix provides definitions and its default setting for the ten GPIO pins in the NIFE 300 series. The pin definition is shown in the following table:

Pin	GPIO Mode	PowerOn Default	Address	Pin	GPIO Mode	PowerOn Default	Address
1	VCC	-	-	2	GND	-	-
3	GPI	Low	A07h (Bit0)	4	GPO	Low	A07h (Bit4)
5	GPI	Low	A07h (Bit1)	6	GPO	Low	A07h (Bit5)
7	GPI	Low	A07h (Bit2)	8	GPO	Low	A07h (Bit6)
9	GPI	Low	A07h (Bit3)	10	GPO	Low	A07h (Bit7)

## JP2 – GPIO Connector

Pin	GPIO Mode	PowerOn Default	Address
A4	GPO	Low	A00h (Bit6)
A3	GPO	Low	A00h (Bit5)
A2	GPO	Low	A02h (Bit7)
A1	GPO	Low	A02h (Bit6)

## LED4 – GPO LED

Control the GPO pin (4/6/8/10) level from I/O port A07h bit (4/5/6/7).

Control the GPO pin (A3/A4) level from I/O port A00h bit (5/6).

Control the GPO pin (A1/A2) level from I/O port A02h bit (6/7).

The bit is Set/Clear indicated output High/Low

## GPIO programming sample code

```
#define GPIO_PORT      0xA00

#define GPO4_HI        outputb(GPIO_PORT+7, 0x10)
#define GPO4_LO        outputb(GPIO_PORT+7, 0x00)
#define GPO6_HI        outputb(GPIO_PORT+7, 0x20)
#define GPO6_LO        outputb(GPIO_PORT+7, 0x00)
#define GPO8_HI        outputb(GPIO_PORT+7, 0x40)
#define GPO8_LO        outputb(GPIO_PORT+7, 0x00)
#define GPO10_HI       outputb(GPIO_PORT+7, 0x80)
#define GPO10_LO       outputb(GPIO_PORT+7, 0x00)
#define GPOA4_HI       outputb(GPIO_PORT, 0x40)
#define GPOA4_LO       outputb(GPIO_PORT, 0x00)
#define GPOA3_HI       outputb(GPIO_PORT, 0x20)
#define GPOA3_LO       outputb(GPIO_PORT, 0x00)
#define GPOA2_HI       outputb(GPIO_PORT+2, 0x80)
#define GPOA2_LO       outputb(GPIO_PORT+2, 0x00)
#define GPOA1_HI       outputb(GPIO_PORT+2, 0x40)
#define GPOA1_LO       outputb(GPIO_PORT+2, 0x00)

void main(void)
{
    GPO4_HI;
    GPO6_LO;
    GPO8_HI;
    GPO10_LO;
    GPOA4_HI;
    GPOA3_LO;
    GPOA2_HI;
    GPOA1_LO;
}
```

## APPENDIX D: RISER CARD 3.3V AND 5V JUMPER CONFIGURATION

Model	Riser Card	PCI/PCIe Combination	Riser Jumper Location and Setting
NIFE 300	No Riser Card	N/A	N/A
NIFE 300E16	NISK300E16	1x PCIe x16	No Jumper
NIFE 300P2E	NISK300P1E1	1x PCIe x8 & 1x PCI	NISK300P1E1 Table
NIFE 300P2	NISK300P2	2x PCI	NISK300P2 Table
NIFE 300P3	NISK300P2E1	1x PCIe x8 & 2x PCI	NISK300P2E1 Table
NIFE 300E3	NISK300E3	1x PCIe x8 & 2x PCIe x4	No Jumper

### NISK300P1E1 Jumper Setting and Location

#### PCI\_VIO (JP2)

Pin	Status	Function Description
1-2 On (Default)	Short	VCC3
2-3 On	Short	VCC5

#### ID Select (JP3)

Pin	Status	Function Description
1-2 On	Short	AD19
3-4 On	Short	AD18
5-6 On	Short	AD17
7-8 On (Default)	Short	AD16

#### INT Select (JP1)

Pin	Status	Function Description
1-2 On	Short	IRQ#D
3-4 On	Short	IRQ#C
5-6 On	Short	IRQ#B
7-8 On (Default)	Short	IRQ#A

## NISK300P2 Jumper Setting and Location

### PCI\_VIO (JP3)

Pin	Status	Function Description
1-2 On (Default)	Short	VCC3
2-3 On	Short	VCC5

## NISK300P2E1 Jumper Setting and Location

### PCI\_VIO (JP3)

Pin	Status	Function Description
1-2 On (Default)	Short	VCC3
2-3 On	Short	VCC5

### INT Select for CN1 Connector (JP4)

Pin	Status	Function Description
1-2 On	Short	IRQ#D
3-4 On	Short	IRQ#B
5-6 On	Short	IRQ#A
7-8 On (Default)	Short	IRQ#C

### INT Select for CN2 Connector (JP2)

Pin	Status	Function Description
1-2 On	Short	IRQ#D
3-4 On	Short	IRQ#C
5-6 On	Short	IRQ#A
7-8 On (Default)	Short	IRQ#B