



**NEXCOM International Co., Ltd.**

**IoT Automation Solutions Business Group**

**Passenger Information Panel PC**

**TPPC 2902**

User Manual

# CONTENTS

## Preface

Copyright .....	iv
Disclaimer .....	iv
Acknowledgements .....	iv
Regulatory Compliance Statements .....	iv
Declaration of Conformity .....	iv
RoHS Compliance .....	v
Warranty and RMA .....	vi
Safety Information .....	ix
Installation Recommendations .....	ix
Safety Precautions .....	x
Technical Support and Assistance .....	xi
Conventions Used in this Manual .....	xi
Global Service Contact Information .....	xii
Package Contents .....	xiv
Ordering Information .....	xv

## Chapter 1: Product Introduction

Overview .....	1
Key Features .....	1
Specifications .....	2
Knowing Your TPPC 2902 .....	4
Rear Bottom .....	4
Mechanical Dimensions .....	5

## Chapter 2: Jumpers and Connectors

Before You Begin .....	6
Precautions .....	6
Jumper Settings .....	7
Locations of the Jumpers and Connectors for the Main Board .....	8
Top View .....	8
Bottom View .....	9
Jumpers .....	10
RTC Reset Pin Header .....	10
Connector Pin Definitions .....	11
External I/O Interfaces .....	11
DC Power Input .....	11
COM Connector .....	11
LAN 1 Port .....	12
LAN 2 Port .....	12
USB 3.0 Ports .....	13
USB 3.0 Ports .....	13
Line-in Connector .....	14
Line-out Connector .....	14
HDMI .....	15
Internal Connectors .....	16
Debug Port .....	16
Battery Connector .....	16
EC Debug Connector .....	17
Light Sensor Connector .....	17
SATA Connector .....	18

SATA Power Connector .....	18
SPI ROM Pin Header .....	19
USB2 JST Connector.....	19
USB2 JST Connector.....	20
UART Pin Header.....	20
MCU Boot Pin Header .....	21
CANbus Connector .....	21
LVDS PWM Mode.....	22
eDP Connector.....	22
LVDS Inverter Connector .....	23
LVDS Connector.....	23
Mic-in Pin Header.....	24
Speaker-out Connector .....	24
Mini-PCIe Connector.....	25
M.2 Connector .....	26

## Chapter 3: System Setup

Removing the Chassis Cover .....	27
Installing a SO-DIMM Memory Module .....	28
Installing an M.2 Module .....	28

## Chapter 4: BIOS Setup

About BIOS Setup .....	30
When to Configure the BIOS.....	30
Default Configuration .....	31
Entering Setup .....	31
Legends .....	31
BIOS Setup Utility.....	33
Main .....	33
Advanced .....	34
Chipset.....	38
Security .....	41
Boot.....	42
Save & Exit .....	43

# PREFACE

## Copyright

This publication, including all photographs, illustrations and software, is protected under international copyright laws, with all rights reserved. No part of this manual may be reproduced, copied, translated or transmitted in any form or by any means without the prior written consent from NEXCOM International Co., Ltd.

## Disclaimer

The information in this document is subject to change without prior notice and does not represent commitment from NEXCOM International Co., Ltd. However, users may update their knowledge of any product in use by constantly checking its manual posted on our website: <http://www.nexcom.com>. NEXCOM shall not be liable for direct, indirect, special, incidental, or consequential damages arising out of the use of any product, nor for any infringements upon the rights of third parties, which may result from such use. Any implied warranties of merchantability or fitness for any particular purpose is also disclaimed.

## Acknowledgements

TPPC 2902 is a trademark of NEXCOM International Co., Ltd. All other product names mentioned herein are registered trademarks of their respective owners.

## Regulatory Compliance Statements

This section provides the FCC compliance statement for Class A devices and describes how to keep the system CE compliant.

## Declaration of Conformity

### FCC

This equipment has been tested and verified to comply with the limits for a Class A digital device, pursuant to Part 15 of FCC Rules. These limits are designed to provide reasonable protection against harmful interference when the equipment is operated in a commercial environment. This equipment generates, uses, and can radiate radio frequency energy and, if not installed and used in accordance with the instructions, may cause harmful interference to radio communications. Operation of this equipment in a residential area (domestic environment) is likely to cause harmful interference, in which case the user will be required to correct the interference (take adequate measures) at their own expense.

### CE

The product(s) described in this manual complies with all applicable European Union (CE) directives if it has a CE marking. For computer systems to remain CE compliant, only CE-compliant parts may be used. Maintaining CE compliance also requires proper cable and cabling techniques.

## RoHS Compliance



### **NEXCOM RoHS Environmental Policy and Status Update**

NEXCOM is a global citizen for building the digital infrastructure. We are committed to providing green products and services, which are compliant with European Union RoHS (Restriction on Use of Hazardous Substance in Electronic Equipment) directive 2011/65/EU, to be your trusted green partner and to protect our environment.

RoHS restricts the use of Lead (Pb) < 0.1% or 1,000ppm, Mercury (Hg) < 0.1% or 1,000ppm, Cadmium (Cd) < 0.01% or 100ppm, Hexavalent Chromium (Cr6+) < 0.1% or 1,000ppm, Polybrominated biphenyls (PBB) < 0.1% or 1,000ppm, and Polybrominated diphenyl Ethers (PBDE) < 0.1% or 1,000ppm.

In order to meet the RoHS compliant directives, NEXCOM has established an engineering and manufacturing task force to implement the introduction of green products. The task force will ensure that we follow the standard NEXCOM development procedure and that all the new RoHS components and new manufacturing processes maintain the highest industry quality levels for which NEXCOM are renowned.

The model selection criteria will be based on market demand. Vendors and suppliers will ensure that all designed components will be RoHS compliant.

### **How to recognize NEXCOM RoHS Products?**

For existing products where there are non-RoHS and RoHS versions, the suffix "(LF)" will be added to the compliant product name.

All new product models launched after January 2013 will be RoHS compliant. They will use the usual NEXCOM naming convention.

## Warranty and RMA

### NEXCOM Warranty Period

1. NEXCOM makes products in accordance with the Industry standard and, NEXCOM warrants that all her Industry-grade IPC and System products will be free from defect in neither material nor workmanship for twenty-four (24) months from the day of invoice issued.
2. For NEXCOM Panel PC product lines (the APPC, MPPC series), they are also guaranteed against defect in materials and workmanship for the period of twenty-four (24) months in their motherboard design. For 3rd party parts, it follows with original suppliers' standard: 12 months for battery pack and LCD, 24 months for adaptor / add on modules (including GSM module, RFID module, and antenna).
3. If NEXCOM determines customer's warranty claim is valid, NEXCOM will repair or replace product(s) without additional charge for parts and labor. An extended Warranty Program will extend the warranty period of the product accordingly.

### Warranty Coverage

The warranty applies only to products manufactured or distributed by NEXCOM and her subsidiaries. This warranty covers all the products/shipments except for:

1. Any claimed defect, products that have been repaired or modified by persons who have not been authorized by NEXCOM or, products which have been subjected to misuse, abuse, accident, improper installation, or usage not in accordance with the product instruction. NEXCOM assumes no liability as a consequence of such events under the term of this warranty.

One example is the replacement of Tablet's or Hand-held's LCD display due to scratching stains or other degradation; these will not be covered under this warranty.

2. Damages caused by customers' delivery/shipping of the product or, product failure resulted from electrical power/voltage shock, or, installation of parts/components which are not supplied/approved by NEXCOM in advance.
3. Third-party products:
  - a. Software, such as the device drivers,
  - b. External devices such as HDD, printer, scanner, mouse, LCD panel, battery, and so on,
  - c. Accessory/parts that were not approved by NEXCOM and,
  - d. Accessory/parts were added to products after they were shipped from NEXCOM.

Product will be treated as "Out of Warranty " if:

- a. It expires the warranted 24 months period from the day it was purchased.
- b. It had been altered by persons other than an authorized NEXCOM service person or, which have been subjected to misuse, abuse, accident, or improper installation.
- c. It doesn't have the original NEXCOM Serial Number labeling for NEXCOM's warranty period identification or, tracking.

RMA that NEXCOM has determined not to be covered by the warranty will be charged the NEXCOM Standard Repair Fee for the repairing. If a RMA is determined to be not repairable, customer will be notified and product(s) may be returned to customer at their request; a minimum service fee may be charged however.

### **NEXCOM Return Merchandise Authorization (RMA) Procedure**

For the RMA (Return Merchandise Authorization) shipment, customer is responsible for packaging and shipping the product to the designated NEXCOM service sites, with shipping charges prepaid by the customer. The original NEXCOM shipping box should be used whenever possible. NEXCOM shall pay for the return of the product to the customer's location. In case of expedited shipping request, an extra service charge shall be assessed and the customer is responsible for this extra return shipping charge.

1. Customers should enclose the "NEXCOM RMA Service Form" with the returned products.
2. Customers need to write down all the information related to the problem on the " NEXCOM RMA Service Form " when applying for the RMA service; information will help to understand the problem, including the fault description, on-screen messages, and pictures if possible.
3. Customers could send back the faulty product with or without the accessories and key parts such as the CPU and DIMM. If the key parts are included, please be noted clearly within the return form. NEXCOM takes no responsibility for the parts which are not listed in the return form.
4. Customers hold the responsibility to ensure that the packing of defective products is durable enough to be resistant against further damage due to the transportation; damage caused by transportation is treated as " Out of Warranty " under our Warranty specification.
5. RMA product(s) returned by NEXCOM to any location other than the

customer registered delivery address will incur an extra shipping charge, the customer is responsible for paying the extra shipping charges, duties, and taxes of this shipment.

### **Product Repairing**

1. NEXCOM will repair defective products covered under this limited warranty that are returned to NEXCOM; if products do prove to be defective, they will be repaired during their warranty period unless other warranty terms have been specified.
2. NEXCOM owns all parts removed from repaired products.
3. NEXCOM will use parts made by various manufacturers in performing the repair.
4. The repaired products will be warranted subjected to the original warranty coverage and period only.
5. For products returned as defective but, proved to be no defect/fault after the RMA process, NEXCOM reserves the right to claim for a NDF (No Defect Found) Service Charge.
6. NEXCOM will issue RMA Report which included Repair Detailed Information to the customer when the defective products were repaired and returned.
7. In addition to the above, NEXCOM may authorize Independent/Third-party suppliers to repair the defective products for NEXCOM.

## Out Of Warranty Service

There will be a service charge from NEXCOM for the “Out Of Warranty” product service; they are the Basic Diagnostic Service Fee and the Advanced Component Replacement Fee respectively. And, if the product can not be repaired, NEXCOM will either return the product to the customer or, just scrap it, followed by customer’s instruction.

### 1. Testing and Parts Replacement

NEXCOM will have the following Handling Charges for those OoW products that returned:

- a. Basic Labor Cost and Testing Fee: as Table listed.
  - b. Parts Fee: NEXCOM will charge for main IC chipsets such as the N.B., S.B., Super-IO, LAN, Sound, Memory, and so on.
  - c. 3rd-party Device Fee: products replacement for CPU, DIMM, HDD, Chassis, and UPS.
2. Out of Warranty product will have a three months warranty for the fixed issues. If the product failed with different problem within 3 months, they will still incur the service charge of “Out of Warranty”.
3. Out of Warranty “products will not be repaired without a signed PI from the customer, the agreement of the repair process.

Add-on card, 3rd Party Device and board level repair cost higher than new product prices, customer can abandon to sign PI to repair and, please contact with sales to buy new products.



## Safety Information

Before installing and using the device, note the following precautions:

- Read all instructions carefully.
- Do not place the unit on an unstable surface, cart, or stand.
- Follow all warnings and cautions in this manual.
- When replacing parts, ensure that your service technician uses parts specified by the manufacturer.
- Avoid using the system near water, in direct sunlight, or near a heating device.
- The load of the system unit does not solely rely for support from the rackmounts located on the sides. Firm support from the bottom is highly necessary in order to provide balance stability.
- The computer is provided with a battery-powered real-time clock circuit. There is a danger of explosion if battery is incorrectly replaced. Replace only with the same or equivalent type recommended by the manufacturer. Discard used batteries according to the manufacturer's instructions.

## Installation Recommendations

Ensure you have a stable, clean working environment. Dust and dirt can get into components and cause a malfunction. Use containers to keep small components separated.

Adequate lighting and proper tools can prevent you from accidentally damaging the internal components. Most of the procedures that follow require only a few simple tools, including the following:

- A Philips screwdriver
- A flat-tipped screwdriver
- A grounding strap
- An anti-static pad

Using your fingers can disconnect most of the connections. It is recommended that you do not use needle-nose pliers to disconnect connections as these can damage the soft metal or plastic parts of the connectors.

## Safety Precautions

1. Read these safety instructions carefully.
2. Keep this User Manual for later reference.
3. Disconnect this equipment from any AC outlet before cleaning. Use a damp cloth. Do not use liquid or spray detergents for cleaning.
4. For plug-in equipment, the power outlet socket must be located near the equipment and must be easily accessible.
5. Keep this equipment away from humidity.
6. Put this equipment on a stable surface during installation. Dropping it or letting it fall may cause damage.
7. The openings on the enclosure are for air convection to protect the equipment from overheating. **DO NOT COVER THE OPENINGS.**
8. Make sure the voltage of the power source is correct before connecting the equipment to the power outlet.
9. Place the power cord in a way so that people will not step on it. Do not place anything on top of the power cord. Use a power cord that has been approved for use with the product and that it matches the voltage and current marked on the product's electrical range label. The voltage and current rating of the cord must be greater than the voltage and current rating marked on the product.
10. All cautions and warnings on the equipment should be noted.
11. If the equipment is not used for a long time, disconnect it from the power source to avoid damage by transient overvoltage.
12. Never pour any liquid into an opening. This may cause fire or electrical shock.
13. Never open the equipment. For safety reasons, the equipment should be opened only by qualified service personnel.
14. If one of the following situations arises, get the equipment checked by service personnel:
  - a. The power cord or plug is damaged.
  - b. Liquid has penetrated into the equipment.
  - c. The equipment has been exposed to moisture.
  - d. The equipment does not work well, or you cannot get it to work according to the user's manual.
  - e. The equipment has been dropped and damaged.
  - f. The equipment has obvious signs of breakage.
15. Do not place heavy objects on the equipment.
16. The unit uses a three-wire ground cable which is equipped with a third pin to ground the unit and prevent electric shock. Do not defeat the purpose of this pin. If your outlet does not support this kind of plug, contact your electrician to replace your obsolete outlet.
17. **CAUTION: DANGER OF EXPLOSION IF BATTERY IS INCORRECTLY REPLACED. REPLACE ONLY WITH THE SAME OR EQUIVALENT TYPE RECOMMENDED BY THE MANUFACTURER. DISCARD USED BATTERIES ACCORDING TO THE MANUFACTURER'S INSTRUCTIONS.**

## Technical Support and Assistance

1. For the most updated information of NEXCOM products, visit NEXCOM's website at [www.nexcom.com](http://www.nexcom.com).
2. For technical issues that require contacting our technical support team or sales representative, please have the following information ready before calling:
  - Product name and serial number
  - Detailed information of the peripheral devices
  - Detailed information of the installed software (operating system, version, application software, etc.)
  - A complete description of the problem
  - The exact wordings of the error messages

### Warning!

1. Handling the unit: carry the unit with both hands and handle it with care.
2. Maintenance: to keep the unit clean, use only approved cleaning products or clean with a dry cloth.
3. CFast: Turn off the unit's power before inserting or removing a CFast storage card.

## Conventions Used in this Manual



### Warning:

Information about certain situations, which if not observed, can cause personal injury. This will prevent injury to yourself when performing a task.



### Caution:

Information to avoid damaging components or losing data.



### Note:

Provides additional information to complete a task easily.

## Global Service Contact Information

### Headquarters

#### NEXCOM International Co., Ltd.

9F, No. 920, Chung-Cheng Rd.,  
Zhonghe District, New Taipei City, 23586,  
Taiwan, R.O.C.  
Tel: +886-2-8226-7786  
Fax: +886-2-8226-7782  
www.nexcom.com

### Asia

#### Taiwan

#### NexAIoT Headquarters

#### Industry 4.0 and Cloud Services

13F, No.916, Zhongzheng Rd.,  
Zhonghe District, New Taipei City,  
23586, Taiwan, R.O.C.  
Tel: +886-2-8226-7796  
Fax: +886-2-8226-7926  
Email: sales@nexaiot.com  
www.nexaiot.com

#### NexAIoT Co., Ltd.

#### Taichung Office

16F, No.250, Sec. 2, Chongde Rd.,  
Beitun District,  
Taichung City, 406, Taiwan, R.O.C.  
Tel: +886-4-2249-1179  
Fax: +886-4-2249-1172  
Email: sales@nexaiot.com  
www.nexaiot.com

#### NexCOBOT Taiwan Co., Ltd.

13F, No.916, Chung-Cheng Rd.,  
Zhonghe District,  
New Taipei City, 23586, Taiwan, R.O.C.  
Tel: +886-2-8226-7786  
Fax: +886-2-8226-7926  
Email: sales@nexcobot.com  
www.nexcobot.com

#### GreenBase Technology Corp.

13F, No.922, Chung-Cheng Rd.,  
Zhonghe District,  
New Taipei City, 23586, Taiwan, R.O.C.  
Tel: +886-2-8226-7786  
Fax: +886-2-8226-7900  
Email: sales@nexcom.com.tw  
www.nexcom.com.tw

#### EMBUX Technology Co., Ltd.

13F, No.916, Chung-Cheng Rd.,  
Zhonghe District,  
New Taipei City, 23586, Taiwan, R.O.C.  
Tel: +886-2-8226-7786  
Fax: +886-2-8226-7782  
Email: sales@nexcom.com.tw  
www.nexcom.com.tw

#### TMR Technology Corp.

13F, No.916, Chung-Cheng Rd.,  
Zhonghe District,  
New Taipei City, 23586, Taiwan, R.O.C.  
Tel: +886-2-8226-7786  
Fax: +886-2-8226-7782  
Email: sales@nexcom.com.tw  
www.nexcom.com.tw

### China

#### NEXSEC Incorporated

5F, No.4, No.7 Fengxian Middle Rd.,  
(Beike Industrial Park), Haidian District,  
Beijing, 100094, China  
Tel: +86-10-5704-2680  
Fax: +86-10-5704-2681  
Email: marketing@nexsec.cn  
www.nexsec.cn

#### NEXCOM Shanghai

No.4, 16 Building,  
Shanghai OMNI Tech & Science Park  
No. 1699, Douhui Rd.,  
Shanghai, 201108, China  
Tel: +86-21-5278-5868  
Fax: +86-21-3251-6358  
Email: sales@nexcom.cn  
www.nexcom.cn

## **NEXCOM Surveillance Technology Corp.**

5F, Building C, ZhenHan Industrial Zone,  
GanKeng Community, Buji Street,  
LongGang District,  
ShenZhen, 518112, China  
Tel: +86-755-8364-7768  
Fax: +86-755-8364-7738  
Email: steveyang@nexcom.com.tw  
www.nexcom.cn

## **NEXCOM United System Service**

Room 603/604, Huiyinmingzun Plaza Bldg. 1,  
No. 609, Yunlin East Rd.,  
Shanghai, 200062, China  
Tel: +86-21-5278-5868  
Fax: +86-21-3251-6358  
Email: renwang@nexcom.com.tw  
www.nexcom.cn

## **NEXGOL Chongqing**

1F, Building B4, Electronic 2nd Area,  
(Phoenix Lake Industrial Park), Yongchuan Dist.,  
Chongqing City, 402160, China  
Tel: +86-23-4960-9080  
Fax: +86-23-4966-5855  
Email: sales@nexgol.com.cn  
www.nexcobot.com/NexGOL

## **NexCOBOT China**

Room 501, Building 1, Haichuang Building,  
No.7 Qingyi Road, Guicheng Street,  
Nanhai District, Foshan City,  
Guangdong Province, 528314, China  
Tel: +86-757-8625-7118  
Email: sales@nexcobot.com  
www.nexcobot.com.cn

## **Beijing NexGemo Technology Co.,Ltd.**

5F, Gemotech Building, No.1, Development Rd.,  
Changping International Information Industry Base,  
Changping District,  
Beijing, 102206, China  
Tel: +86-10-8190-9328  
Fax: +86-10-8190-9456  
Email: sales@gemotech.cn  
www.nexgemo.cn

## **Japan**

### **NEXCOM Japan**

9F, Tamachi Hara Bldg.,  
4-11-5, Shiba Minato-ku,  
Tokyo, 108-0014, Japan  
Tel: +81-3-5419-7830  
Fax: +81-3-5419-7832  
Email: sales@nexcom-jp.com  
www.nexcom-jp.com

## **America**

### **USA NEXCOM USA**

46665 Fremont Blvd.,  
Fremont CA 94538, USA  
Tel: +1-510-656-2248  
Fax: +1-510-656-2158  
Email: sales@nexcom.com  
www.nexcomusa.com

## **Europe**

### **United Kingdom NEXCOM EUROPE**

10 Vincent Avenue,  
Crownhill Business Centre,  
Milton Keynes, Buckinghamshire  
MK8 0AB, United Kingdom  
Tel: +44-1908-267121  
Fax: +44-1908-262042  
Email: sales.uk@nexcom.eu  
www.nexcom.co.uk

## Package Contents

Before continuing, verify that the package you received is complete. Your package should have all the items listed in the table.

Item	Name	Qty
1	I Head Screw	3
2	PE Zipper Bag #3	1
3	Driver DVD	1

## Ordering Information

The following information below provides ordering information for the Passenger Information Panel PC.

### Barebone

- **TPPC 2902 (P/N: 10ID0290200X1)**  
28.8" bar-type 1920 x 600 Passenger Information Panel PC,  
Intel Atom® x5-E3930

# CHAPTER 1: PRODUCT INTRODUCTION

## Overview



## Key Features

- 28.8" TFT-LCD 1920 x 600 bar-type fanless panel computer
- Powered by Intel Atom® x5-E3930 processor, 1.3GHz
- Wide-range DC input of 9V to 36V DC
- Support ignition control for power on/off delay timing management
- Compliant with IP54 on the front panel
- Tempered glass, surface hardness 6H
- 1 x DDR3L up to 8GB, M.2 2242 Key B SSD for storage device
- 1 x mini-PCIe expansion available for wireless communication
- CE/FCC/E/e-Mark



## Specifications

### LCD Panel

- LCD size: 28.8 bar-type
- Resolution: 1920 x 600
- Luminance: 500 nits cd/m<sup>2</sup>
- Contrast ratio: 1,400
- LCD color: 16.7M
- View angle: 178 (H), 178 (V)
- Backlight: LED

### System

- Intel Atom® x5 E3930 processor, 1.3GHz (burst mode: 1.8GHz)

### System Front

- 1 x Ambient light sensor

### Main Memory

- 1 x 204-pin DDR3L SO-DIMM socket, up to 8GB. Support up to 1866 MHz, non-ECC and unbuffered memory.

### Rear I/O

- 1 x Power input connector, 6-pin (9V-36V DC & Ignition control)
- 1 x DB9 COM port for RS232/422/485
- 2 x RJ45 Intel® I210-AT gigabit LAN ports
- 4 x USB 3.0, support USB 2.0
- 1 x HDMI 1.4b (support 4K x 2K@30Hz)
- 1 x Line-in, Line-out with 16Ω Amplifier

### Audio

- Realtek ALC886 audio codec

### Storage Device

- 1 x M.2 (2242) B key SSD, up to 256GB max.
- 1 x 2.5" SATA SSD reserved for expansion

### Expansion

- 1 x mini-PCIe full-size connector on board (supports PCIe/USB)

### Power Management

- 9V to 36V DC input (UPS: 12V, 24V and 36V)
- Ignition on/off control & programmable on/off delay timing

### Environment

- Vibration
  - IEC60068-2-64
  - Operating: 1G, random, 5-500Hz, 1hr/axis (w/storage)
- Drop
  - IEC60068-2-32
  - ISTA-2A-STD
  - 13.9kg (packing weight) & 81cm (falling height)
- Temperature
  - Operating temperature: 0~50°C
  - Storage Temperatures: 0~70°C
  - Damp Heat test per EN60068-2-30
  - Damp heat steady test 45~55°C, 95%, 48Hrs, non-condensing

### Operating System Support

- Windows 10 IoT Enterprise 64-bit
- Linux Yocto 4.14

## Mechanical Information

- Color: Pantone black
- VESA mount (200mm x 200mm; 400mm x 200mm)
- Dimension: 777.3mm (W) x 292.8mm (D) x 70.1mm (H)
- System weight (N.W): 13.3kg, 29.32lb
- Package weight (G.W): 13.9kg, 30.64lb

## Certification

- CE (EN55024, EN55032, EN55035)
- FCC Class A (EMI Part 15B)
- e-Mark: e13, 12/24V

## Knowing Your TPPC 2902

### Rear Bottom

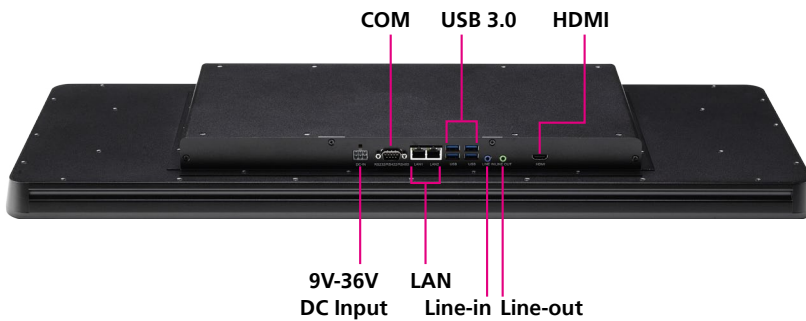

#### 9V-36V DC Input

Used to plug a DC power cord.

#### COM Port

DB9 port used to connect RS232/422/485 compatible devices.

#### LAN Ports

Used to connect the system to a local area network.

#### USB 3.0 Ports

USB 3.0 ports to connect the system with USB 3.0/2.0 devices.

#### Line-in

Used to connect an audio device as sound source.

#### Line-out

Used to connect a headphone or a speaker.

#### HDMI

Used to connect an HDMI interface display.

# Mechanical Dimensions

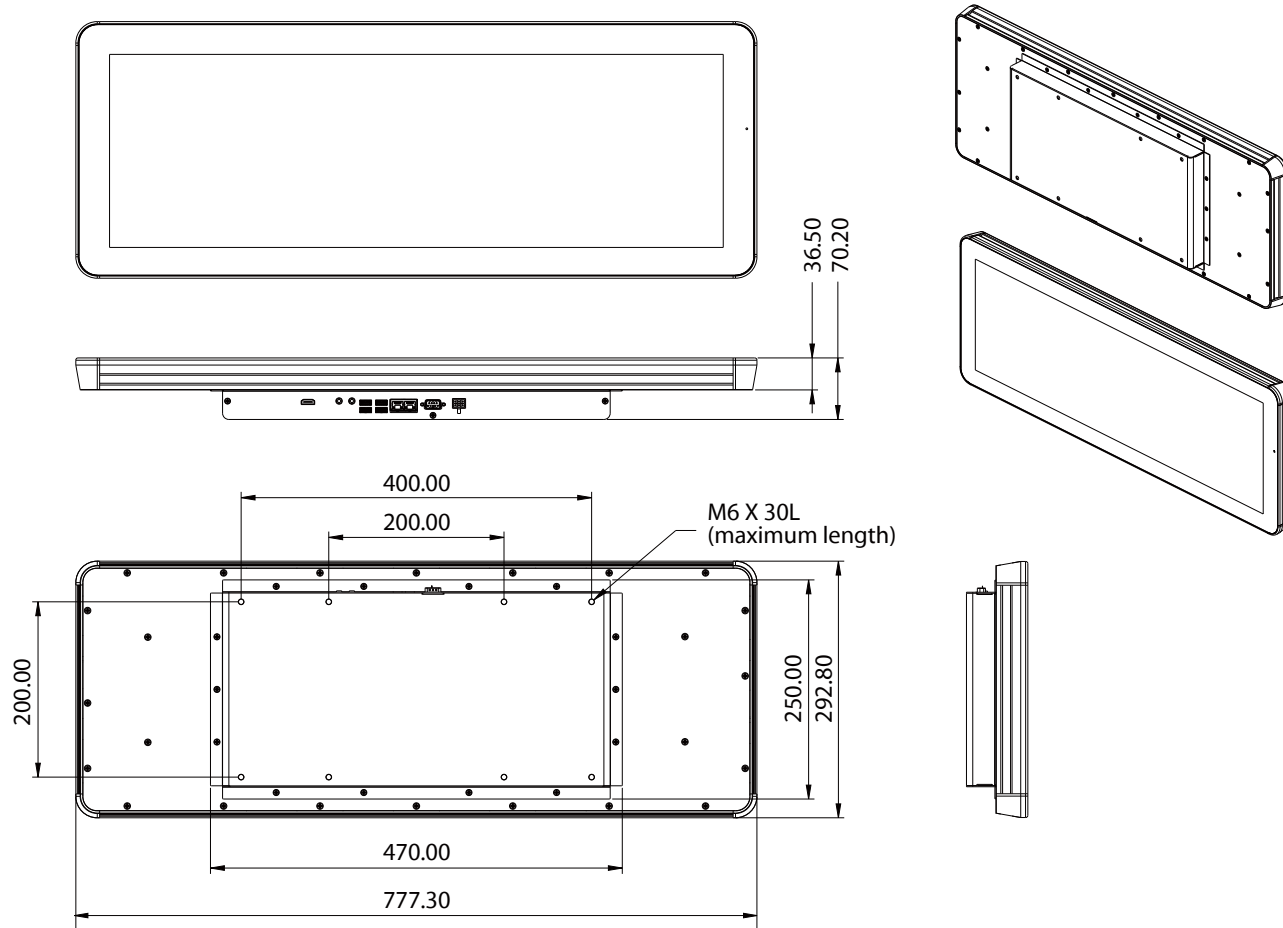

# CHAPTER 2: JUMPERS AND CONNECTORS

This chapter describes how to set the jumpers and connectors on the TPPC 2902 motherboard.

## Before You Begin

- Ensure you have a stable, clean working environment. Dust and dirt can get into components and cause a malfunction. Use containers to keep small components separated.
- Adequate lighting and proper tools can prevent you from accidentally damaging the internal components. Most of the procedures that follow require only a few simple tools, including the following:
  - A Philips screwdriver
  - A flat-tipped screwdriver
  - A set of jewelers screwdrivers
  - A grounding strap
  - An anti-static pad
- Using your fingers can disconnect most of the connections. It is recommended that you do not use needle-nosed pliers to disconnect connections as these can damage the soft metal or plastic parts of the connectors.
- Before working on internal components, make sure that the power is off. Ground yourself before touching any internal components, by touching a metal object. Static electricity can damage many of the electronic components. Humid environments tend to have less static electricity than

dry environments. A grounding strap is warranted whenever danger of static electricity exists.

## Precautions

Computer components and electronic circuit boards can be damaged by discharges of static electricity. Working on computers that are still connected to a power supply can be extremely dangerous.

Follow the guidelines below to avoid damage to your computer or yourself:

- Always disconnect the unit from the power outlet whenever you are working inside the case.
- If possible, wear a grounded wrist strap when you are working inside the computer case. Alternatively, discharge any static electricity by touching the bare metal chassis of the unit case, or the bare metal body of any other grounded appliance.
- Hold electronic circuit boards by the edges only. Do not touch the components on the board unless it is necessary to do so. Don't flex or stress the circuit board.
- Leave all components inside the static-proof packaging that they shipped with until they are ready for installation.
- Use correct screws and do not over tighten screws.

## Jumper Settings

A jumper is the simplest kind of electric switch. It consists of two metal pins and a cap. When setting the jumpers, ensure that the jumper caps are placed on the correct pins. When the jumper cap is placed on both pins, the jumper is short. If you remove the jumper cap, or place the jumper cap on just one pin, the jumper is open.

Refer to the illustrations below for examples of what the 2-pin and 3-pin jumpers look like when they are short (on) and open (off).

Two-Pin Jumpers: Open (Left) and Short (Right)

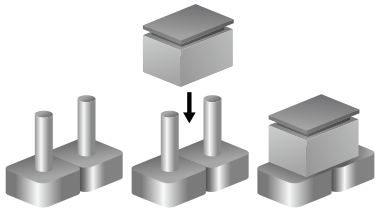

Three-Pin Jumpers: Pins 1 and 2 are Short

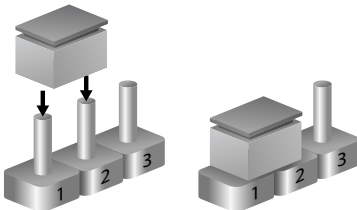

## Locations of the Jumpers and Connectors for the Main Board

The figure below is the top view of the main board used in TPPC 2902. It shows the locations of the jumpers and connectors.

Top View

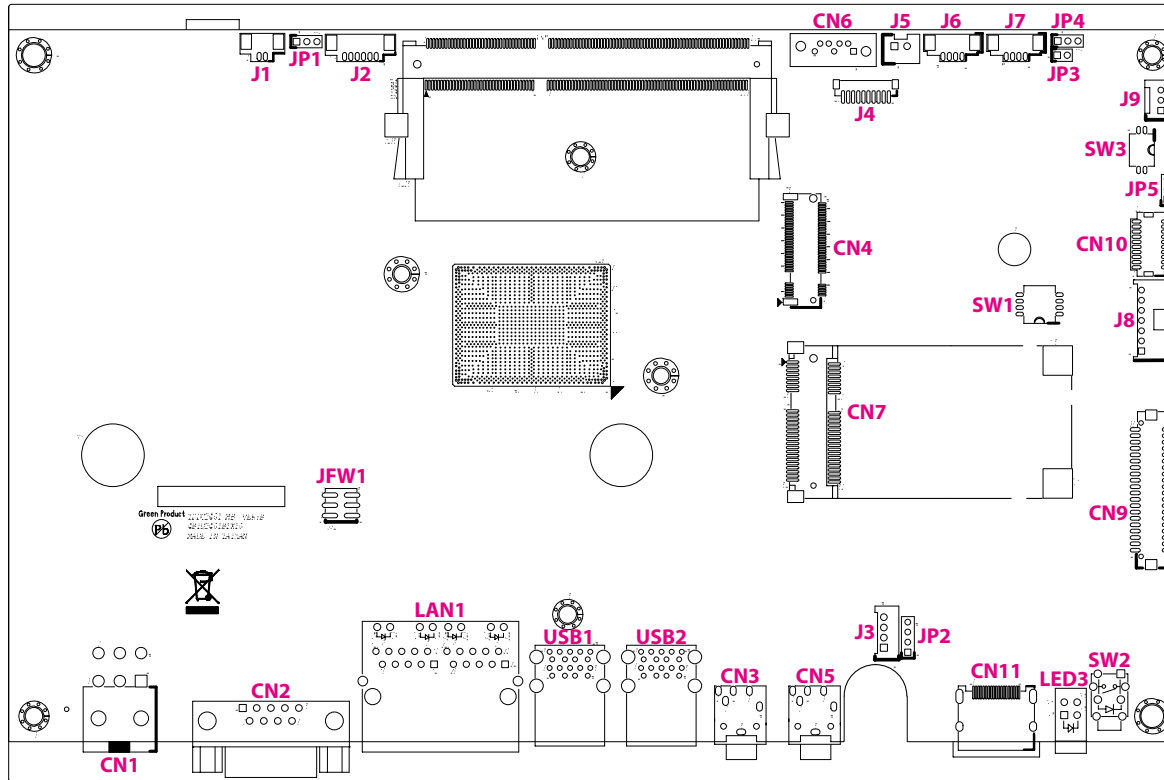

### Bottom View

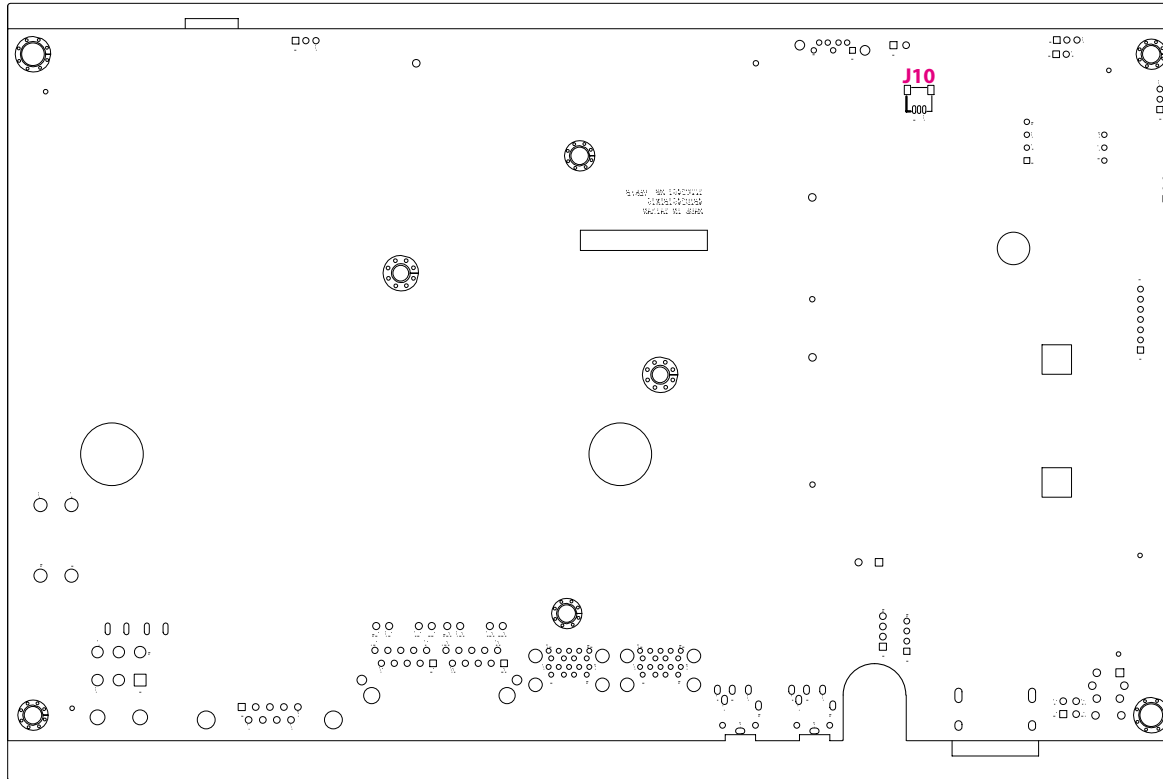



## Jumpers

### RTC Reset Pin Header

Connector type: 1x3 3-pin header, 2.0mm pitch

Connector location: JP1



Pin	Settings
1-2 On	N/A
2-3 On	RTC Reset

1-2 On: default

## Connector Pin Definitions

### External I/O Interfaces

#### DC Power Input

Connector type: 2x3 6-pin terminal block connector

Connector location: CN1

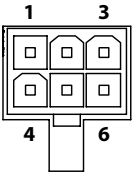

Pin	Definition	Pin	Definition
1	VIN	2	VIN
3	IGNITION	4	GND
5	GND	6	GND
NH1	NC	NH2	NC

#### COM Connector

Connector type: DB-9 port, 9-pin D-Sub

Connector location: CN2

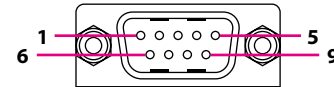

Pin	Definition	Pin	Definition
1	DCD#	2	RXD
3	TXD	4	DTR#
5	GND	6	DSR#
7	RTS#	8	CTS#
9	RI#		
MH1	GND	MH2	GND

## LAN 1 Port

Connector type: RJ45 with LEDs

Connector location: LAN1A

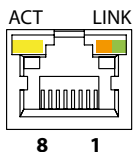

Act	Status
Flashing Yellow	Data activity
Off	No activity

Link	Status
Steady Green	1G network link
Steady Orange	100Mbps network link
Off	10Mbps or no link

Pin	Definition	Pin	Definition
1	LAN1_MDI0P	2	LAN1_MID0N
3	LAN1_MDI1P	4	LAN1_MDI1N
5	LAN1_VCC	6	LAN1_GND
7	LAN1_MDI2P	8	LAN1_MDI2N
9	LAN1_MDI3P	10	LAN1_MDI3N
11	LAN1_LINK1000	12	LAN1_LINK100
13	LAN1_ACT	14	LAN1_LEDPWR

## LAN 2 Port

Connector type: RJ45 with LEDs

Connector location: LAN1B

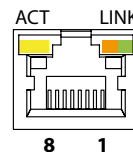

Act	Status
Flashing Yellow	Data activity
Off	No activity

Link	Status
Steady Green	1G network link
Steady Orange	100Mbps network link
Off	10Mbps or no link

Pin	Definition	Pin	Definition
1	LAN2_MDI0P	2	LAN2_MID0N
3	LAN2_MDI1P	4	LAN2_MDI1N
5	LAN2_VCC	6	LAN2_GND
7	LAN2_MDI2P	8	LAN2_MDI2N
9	LAN2_MDI3P	10	LAN2_MDI3N
11	LAN2_LINK1000	12	LAN2_LINK100
13	LAN2_ACT	14	LAN2_LEDPWR

## USB 3.0 Ports

Connector type: Dual USB 3.0 ports

Connector location: USB1

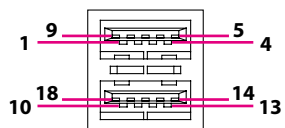

Pin	Definition	Pin	Definition
1	VCC5	2	USB2_DN1
3	USB2_DP1	4	GND
5	USB3_RXN1	6	USB3_RXP1
7	GND	8	USB3_TXN1
9	USB3_TXP1	10	VCC5
11	USB2_DN2	12	USB2_DP2
13	GND	14	USB3_RXN2
15	USB3_RXP2	16	GND
17	USB3_TXN2	18	USB3_TXP2

## USB 3.0 Ports

Connector type: Dual USB 3.0 ports

Connector location: USB2

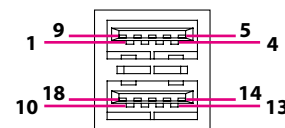

Pin	Definition	Pin	Definition
1	VCC5	2	USB2_DN3
3	USB2_DP3	4	GND
5	USB3_RXN3	6	USB3_RXP3
7	GND	8	USB3_TXN3
9	USB3_TXP3	10	VCC5
11	USB2_DN4	12	USB2_DNP4
13	GND	14	USB3_RXN4
15	USB3_RXP4	16	GND
17	USB3_TXN4	18	USB3_TXP4

## Line-in Connector

Connector type: 1x 3.5mm audio jack

Connector location: CN3



Pin	Definition	Pin	Definition
1	LINE_IN_R	2	LINE_JD
3	AGND	4	LINE_IN_L
5	AGND	6	AGND

## Line-out Connector

Connector type: 1x 3.5mm audio jack

Connector location: CN5

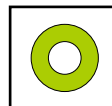

Pin	Definition	Pin	Definition
1	HP_OUT_R	2	LINE2_JD
3	AGND	4	HP_OUT_L
5	AGND	6	AGND

## HDMI

Connector type: HDMI port

Connector location: CN11

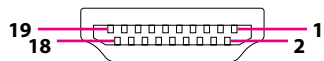

Pin	Definition	Pin	Definition
1	HDMI_TX2P	2	GND
3	HDMI_TX2N	4	HDMI_TX1P
5	GND	6	HDMI_TX1N
7	HDMI_TX0P	8	GND
9	HDMI_TX0N	10	HDMI_CLKP
11	GND	12	HDMI_CLKN
13	NC	14	NC
15	HDMI_DDCCLK	16	HDMI_DDCDATA
17	GND	18	VCC5
19	HDMI_HPD		
MH1	CHASSIS_GND	MH2	CHASSIS_GND

## Internal Connectors

### Debug Port

Connector type: 1x10 10-pin header, 1.0mm pitch

Connector location: J4

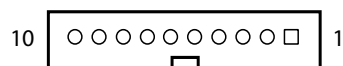

Pin	Definition	Pin	Definition
1	GND	2	PLTRST#
3	LPC_CLK	4	LPC_FRAME#
5	LPC_AD3	6	LPC_AD2
7	LPC_AD1	8	LPC_ADO
9	VCC3	10	VCC3

### Battery Connector

Connector type: 1x2 2-pin header, 1.25mm pitch

Connector location: J1

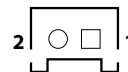

Pin	Definition
1	VCC
2	GND

## EC Debug Connector

Connector type: 1x3 3-pin header, 1.0mm pitch

Connector location: J10

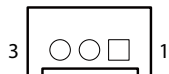

Pin	Definition
1	SMBCLK
2	SMBDATA
3	GND

## Light Sensor Connector

Connector type: 1x6 6-pin header, 1.25mm pitch

Connector location: J2

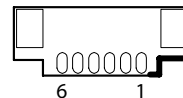

Pin	Definition	Pin	Definition
1	NC	2	VCC3
3	GND	4	I2CDATA
5	I2CCLK	6	INT



## SATA Connector

Connector type: Standard Serial ATA 7P (1.27mm, SATA-M-180)

Connector location: CN6

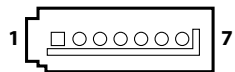

Pin	Definition	Pin	Definition
1	GND	2	SATA_TXP
3	SATA_TXN	4	GND
5	SATA_RXN	6	SATA_RXP
7	GND		

## SATA Power Connector

Connector type: 1x2 2-pin header, 2.5mm pitch

Connector location: J5

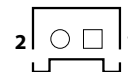

Pin	Definition
1	VCC5
2	GND

## SPI ROM Pin Header

Connector type: 2x3 6-pin header, 2.0mm pitch

Connector location: JFW1

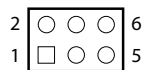

Pin	Definition	Pin	Definition
1	VCC	2	GND
3	SPI_CS#	4	SPI_CLK
5	SPI_SO	6	SPI_SI

## USB2 JST Connector

Connector type: 1x4 4-pin header, 1.25mm pitch

Connector location: J6

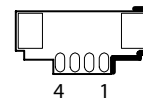

Pin	Definition	Pin	Definition
1	VCC5	2	USB2_DN5
3	USB2_DP5	4	GND

## USB2 JST Connector

Connector type: 1x4 4-pin header, 1.25mm pitch

Connector location: J7

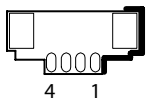

Pin	Definition	Pin	Definition
1	VCC5	2	USB2_DN6
3	USB2_DP6	4	GND

## UART Pin Header

Connector type: 1x3 3-pin header, 2.0mm pitch

Connector location: JP4

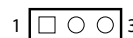

Pin	Definition
1	COM_TX
2	COM_RX
3	GND

## MCU Boot Pin Header

Connector type: 1x2 2-pin header, 2.0mm pitch

Connector location: JP3



Pin	Definition
1	MCU_BOOT
3	GND

## CANbus Connector

Connector type: 1x3 3-pin header, 2.0mm pitch

Connector location: J9



Pin	Definition
1	CAN_H
2	CAN_L
3	CANISO_GND



Note:  
Reserved function, not available in standard products.

## LVDS PWM Mode

Connector type: 1x3 3-pin header, 2.0mm pitch

Connector location: JP5



Pin	Definition
1	VCC3
2	BKLTCTRL
3	VCC5

## eDP Connector

Connector type: 2x10 20-pin header, 1.0mm pitch

Connector location: CN10

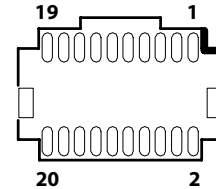

Pin	Definition	Pin	Definition
1	VCC5	2	VCC12
3	VCC5	4	VCC12
5	EDP_TXP0	6	GND
7	EDP_TXN0	8	VCC3
9	GND	10	VCC3
11	EDP_TXP1	12	GND
13	EDP_TXN1	14	BKLTCTRL
15	GND	16	EDP_HPD
17	EDP_AUXP	18	GND
19	EDP_AUXN	20	BKLTEN

## LVDS Inverter Connector

Connector type: 1x7 7-pin header, 2.0mm pitch

Connector location: J8

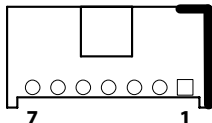

Pin	Definition	Pin	Definition
1	VCC5	2	VCC12
3	VCC12	4	BKLTCTRL
5	GND	6	GND
7	BKLTEN		

## LVDS Connector

Connector type: 2x20 40-pin header, 1.25mm pitch

Connector location: CN9



Pin	Definition	Pin	Definition
1	LVDS_TP3	2	LVDS_TP7
3	LVDS_TN3	4	LVDS_TN7
5	GND	6	GND
7	LVDS_CLKP1	8	LVDS_CLKP2
9	LVDS_CLKN1	10	LVDS_CLKN2
11	GND	12	GND
13	LVDS_TP2	14	LVDS_TP6
15	LVDS_TN2	16	LVDS_TN6
17	GND	18	GND
19	LVDS_TP1	20	LVDS_TP5
21	LVDS_TN1	22	LVDS_TN5
23	GND	24	GND
25	LVDS_TP0	26	LVDS_TP4
27	LVDS_TN0	28	LVDS_TN4
29	GND	30	GND
31	VCC3	32	VCC5
33	VCC3	34	VCC5
35	VCC3	36	VCC5
37	VCC3	38	VCC5
39	VCC12	40	VCC12

## Mic-in Pin Header

Connector type: 1x4 4-pin header, 2.0mm pitch

Connector location: JP2

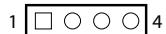

Pin	Definition	Pin	Definition
1	MIC_L	2	AGND
3	MIC_JD	4	MIC_R

## Speaker-out Connector

Connector type: 1x4 4-pin header, 2.0mm pitch

Connector location: J3

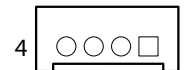

Pin	Definition	Pin	Definition
1	ROUT_P	2	ROUT_N
3	LOUT_P	4	LOUT_N

## Mini-PCIe Connector

Connector location: CN7

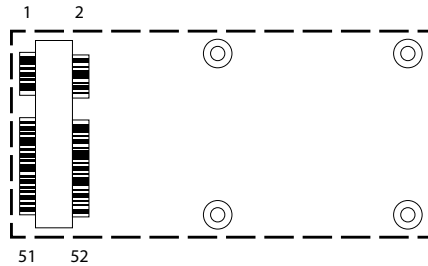

Pin	Definition	Pin	Definition
1	PCIE_WAKE#	2	3VSB
3	NC	4	GND
5	NC	6	1.5V
7	CLKREQ#	8	NC
9	GND	10	NC
11	PCIE_CLK#	12	NC
13	PCIE_CLK	14	NC
15	GND	16	NC
17	NC	18	GND
19	NC	20	DISABLE#
21	GND	22	PCIE_RESET#
23	PCIE_RXN	24	3VSB
25	PCIE_RXP	26	GND

Pin	Definition	Pin	Definition
27	GND	28	1.5V
29	GND	30	SMB_CLK
31	PCIE_TXN	32	SMB_DATA
33	PCIE_TXP	34	GND
35	GND	36	USB_N
37	GND	38	USB_P
39	3VSB	40	GND
41	3VSB	42	NC
43	GND	44	NC
45	NC	46	NC
47	NC	48	1.5V
49	NC	50	GND
51	NC	52	3VSB



## M.2 Connector

Connector location: CN4

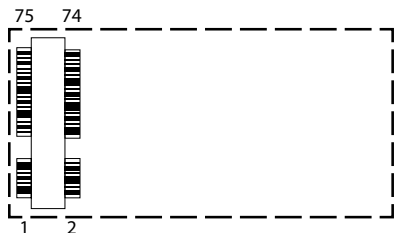

Pin	Definition	Pin	Definition
1	M2_CFG3	2	VCC3
3	GND	4	VCC3
5	GND	6	NC
7	USB2_DP8	8	NC
9	USB2_DN8	10	M2_DSS#
11	NC	20	NC
21	M2_CFG0	22	NC
23	NC	24	NC
25	NC	26	NC
27	GND	28	NC
29	NC	30	NC
31	NC	32	NC
33	GND	34	NC
35	NC	36	NC
37	NC	38	M2_DEVSLP
39	GND	40	NC
41	SATA_RXP	42	NC

Pin	Definition	Pin	Definition
43	SATA_RXN	44	NC
45	GND	46	NC
47	SATA_TXN	48	NC
49	SATA_TXP	50	NC
51	GND	52	NC
53	NC	54	NC
55	NC	56	NC
57	GND	58	NC
59	NC	60	NC
61	NC	62	NC
63	NC	64	NC
65	NC	66	NC
67	NC	68	NC
69	M2_CFG1	70	VCC3
71	GND	72	VCC3
73	GND	74	VCC3
75	M2_CFG2		

## CHAPTER 3: SYSTEM SETUP

### Removing the Chassis Cover



Prior to removing the chassis cover, make sure the unit's power is off and disconnected from the power sources to prevent electric shock or system damage.

1. Locate the 38 screws on the bottom side of the chassis cover.

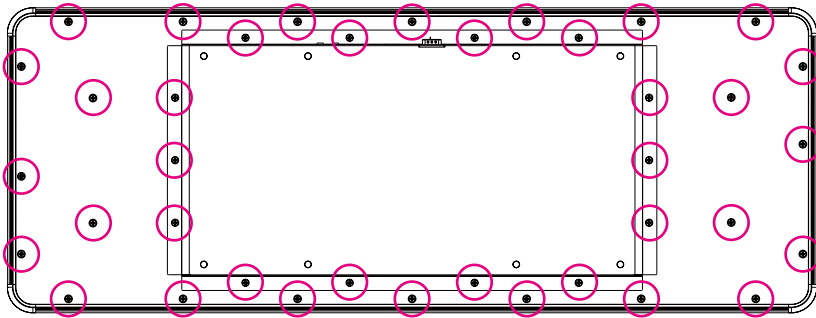

2. Remove the 38 screws and then remove the chassis cover.



## Installing a SO-DIMM Memory Module

1. With the chassis cover removed, locate the SO-DIMM socket and insert the module into the socket at an approximately 30 degrees angle. Push the module down until the clips on both sides of the socket lock into position. The clips at the ends of the socket will automatically snap into the locked position to hold the module in place.



Memory Module

## Installing an M.2 Module

1. With the chassis cover removed, locate the M.2 socket and insert the module into the socket at an approximately 45 degrees angle until the gold-plated connector on the edge of the module completely disappears into the slot.

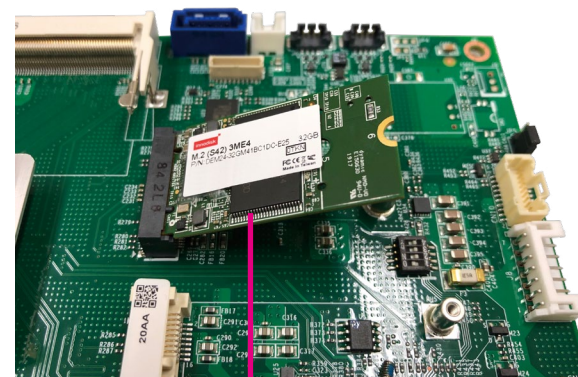

M.2 Module

2. Push the module down and secure it with a screw.

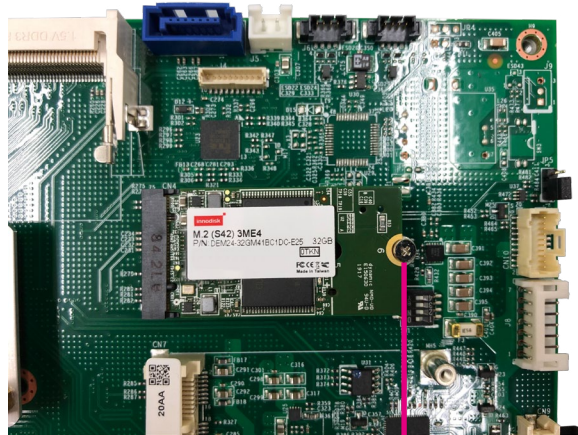

**Mounting Screw**

# CHAPTER 4: BIOS SETUP

This chapter describes how to use the BIOS setup program for TPPC 2902. The BIOS screens provided in this chapter are for reference only and may change if the BIOS is updated in the future.

To check for the latest updates and revisions, visit the NEXCOM website at [www.nexcom.com.tw](http://www.nexcom.com.tw).

## About BIOS Setup

The BIOS (Basic Input and Output System) Setup program is a menu driven utility that enables you to make changes to the system configuration and tailor your system to suit your individual work needs. It is a ROM-based configuration utility that displays the system's configuration status and provides you with a tool to set system parameters.

These parameters are stored in non-volatile battery-backed-up CMOS RAM that saves this information even when the power is turned off. When the system is turned back on, the system is configured with the values found in CMOS.

With easy-to-use pull down menus, you can configure such items as:

- Hard drives, diskette drives, and peripherals
- Video display type and display options
- Password protection from unauthorized use
- Power management features

The settings made in the setup program affect how the computer performs. It is important, therefore, first to try to understand all the setup options, and second, to make settings appropriate for the way you use the computer.

## When to Configure the BIOS

- This program should be executed under the following conditions:
  - When changing the system configuration
  - When a configuration error is detected by the system and you are prompted to make changes to the setup program
  - When resetting the system clock
  - When redefining the communication ports to prevent any conflicts
  - When making changes to the Power Management configuration
  - When changing the password or making other changes to the security setup

Normally, CMOS setup is needed when the system hardware is not consistent with the information contained in the CMOS RAM, whenever the CMOS RAM has lost power, or the system features need to be changed.

## Default Configuration

Most of the configuration settings are either predefined according to the Load Optimal Defaults settings which are stored in the BIOS or are automatically detected and configured without requiring any actions. There are a few settings that you may need to change depending on your system configuration.

## Entering Setup











When the system is powered on, the BIOS will enter the Power-On Self Test (POST) routines. These routines perform various diagnostic checks; if an error is encountered, the error will be reported in one of two different ways:

- If the error occurs before the display device is initialized, a series of beeps will be transmitted.
- If the error occurs after the display device is initialized, the screen will display the error message.

Powering on the computer and immediately pressing <Del> allows you to enter Setup.

Press the  key to enter Setup:

## Legends

Key	Function
	Moves the highlight left or right to select a menu.
	Moves the highlight up or down between sub-menus or fields.
	Exits the BIOS Setup Utility.
	Scrolls forward through the values or options of the highlighted field.
	Scrolls backward through the values or options of the highlighted field.
	Selects a field.
	Displays General Help.
	Load previous values.
	Load optimized default values.
	Saves and exits the Setup program.
	Press <Enter> to enter the highlighted sub-menu

## Scroll Bar

When a scroll bar appears to the right of the setup screen, it indicates that there are more available fields not shown on the screen. Use the up and down arrow keys to scroll through all the available fields.

## Submenu

When “▶” appears on the left of a particular field, it indicates that a submenu which contains additional options are available for that field. To display the submenu, move the highlight to that field and press  .

## BIOS Setup Utility

Once you enter the AMI BIOS Setup Utility, the Main Menu will appear on the screen. The main menu allows you to select from several setup functions and one exit. Use arrow keys to select among the items and press  to accept or enter the submenu.

### Main

The Main menu is the first screen that you will see when you enter the BIOS Setup Utility.

### System Date

The date format is <day>, <month>, <date>, <year>. Day displays a day, from Monday to Sunday. Month displays the month, from January to December. Date displays the date, from 1 to 31. Year displays the year, from 2005 to 2099.

### System Time

The time format is <hour>, <minute>, <second>. The time is based on the 24-hour military-time clock. For example, 1 p.m. is 13:00:00. Hour displays hours from 00 to 23. Minute displays minutes from 00 to 59. Second displays seconds from 00 to 59.

Aptio Setup Utility - Copyright (C) 2019 American Megatrends, Inc.					
Main	Advanced	Chipset	Security	Boot	Save & Exit
<b>BIOS Information</b>		American Megatrends		Set the Date. Use Tab to switch between Date elements.	
BIOS Vendor	5.12		Default Ranges:		
Core Version	UEFI 2.5; PI 1.4		Year: 2005-2099		
Compliance	T241-004 x64		Months: 1-12		
Project Version	09/11/2019 16:51:26		Days: dependent on month		
Build Date and Time	C001				
EC Version	Administrator				
Access Level					
<b>Platform firmware Information</b>					
BXT SOC	F1				
TXE FW	3.0.13.114				
GOP	10.0.1036				
<b>Memory Information</b>					
Total Memory	8192 MB				
Memory Speed	1600 MHz				
<b>System Date</b>		[Wed 12/09/2020]			
<b>System Time</b>		[04:07:20]			
				←→: Select Screen ↑↓: Select Item Enter: Select +/-: Change Opt. F1: General Help F2: Previous Values F3: Optimized Defaults F4: Save & Exit ESC: Exit	
Version 2.18.1263. Copyright (C) 2019 American Megatrends, Inc.					



## Advanced

The Advanced menu allows you to configure your system for basic operation. Some entries are defaults required by the system board, while others, if enabled, will improve the performance of your system or let you set some features according to your preference.



Setting incorrect field values may cause the system to malfunction.

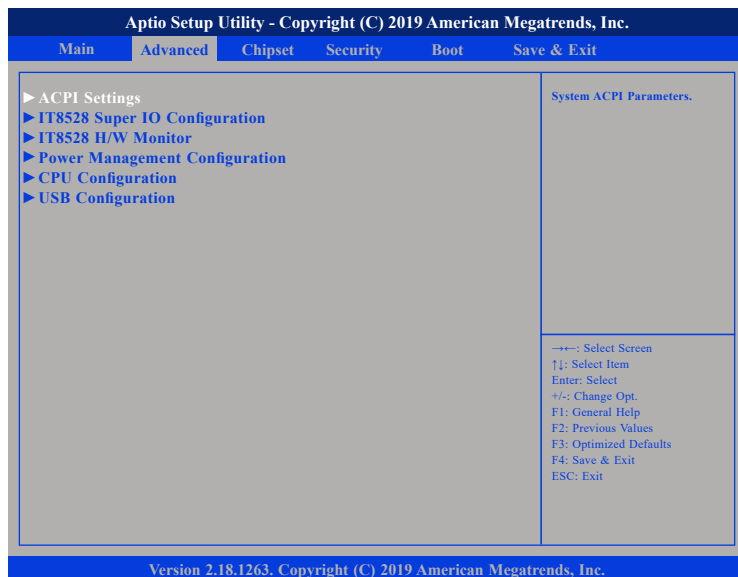

## ACPI Settings

This section is used to configure ACPI settings.

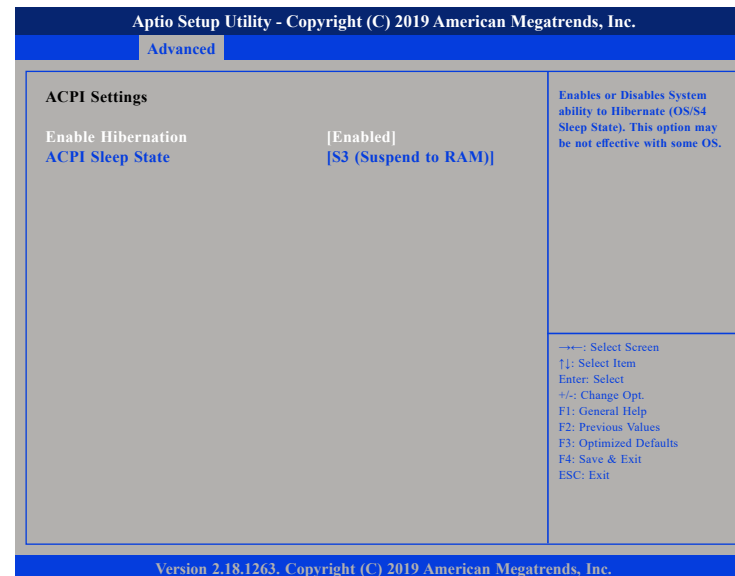

### Enable Hibernation

Enables or disables system ability to hibernate (OS/S4 Sleep State). This option may not be effective with some OS.

### ACPI Sleep State

Select the highest ACPI sleep state the system will enter when the suspend button is pressed. The options are Suspend Disabled and S3 (Suspend to RAM).

## IT8528 Super IO Configuration

This section is used to configure the serial ports of the IT8528 Super IO.

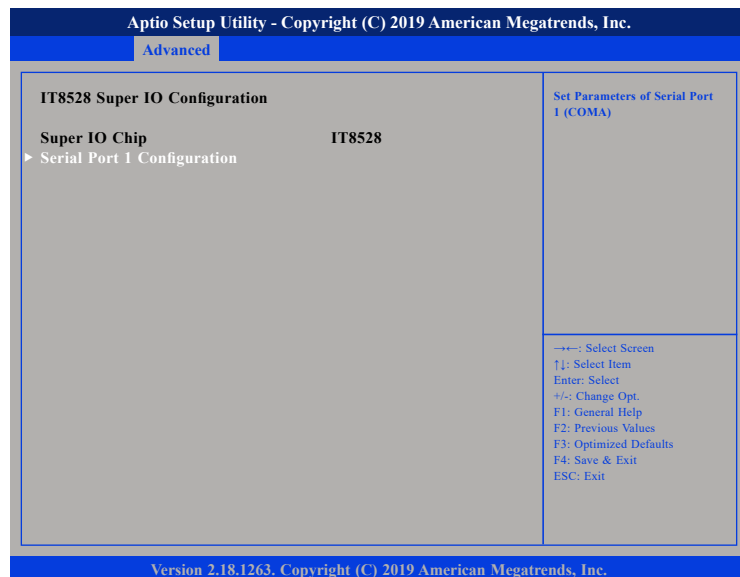

### Super IO Chip

Displays the Super I/O chip used on the board.

## Serial Port 1 Configuration

This section is used to configure serial port 1.



### Serial Port

Enables or disables the serial port.

## IT8528 H/W Monitor

This section is used to monitor hardware status such as temperature, fan speed and voltages.

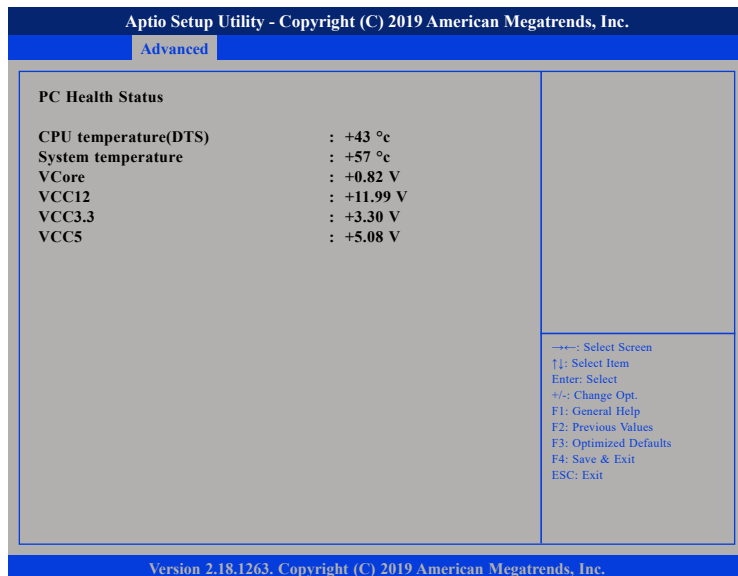

### CPU temperature(DTS)

Detects and displays the current CPU temperature.

### System temperature

Detects and displays the current system temperature.

### VCore to VCC5

Detects and displays the output voltages.

## Power Management Configuration

This section is used to configure the power delay settings.

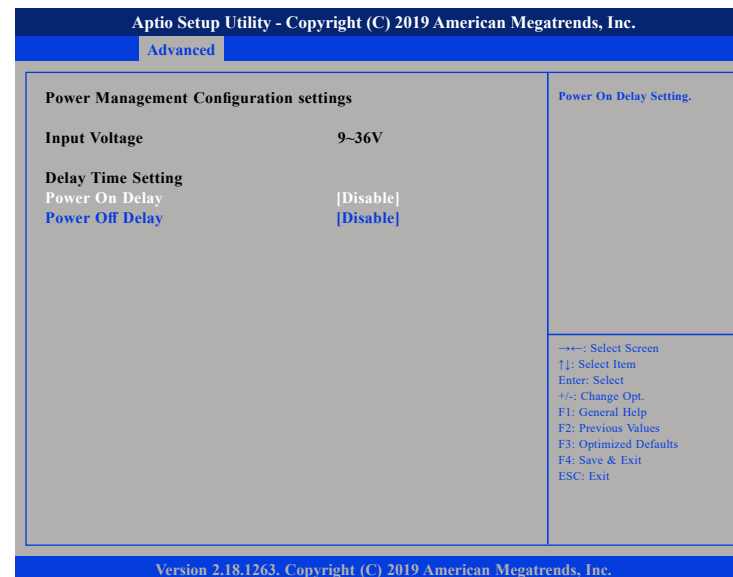

### Power On Delay

Enables or disables the Power On Delay function.

### Power Off Delay

Enables or disables the Power Off Delay function.

## CPU Configuration

This section is used to configure the CPU.



### Socket 0 CPU Information

The submenu that displays information on the CPU installed on socket 0.

### CPU Power Management

The submenu for configuring CPU power management settings.

### Active Processors Cores

Select the number of cores to enable in each processor package.

### Intel® Virtualization Technology

Enables or disables Intel Virtualization technology.

### VT-d

Enables or disables the VT-d function.

## USB Configuration

This section is used to configure the USB.

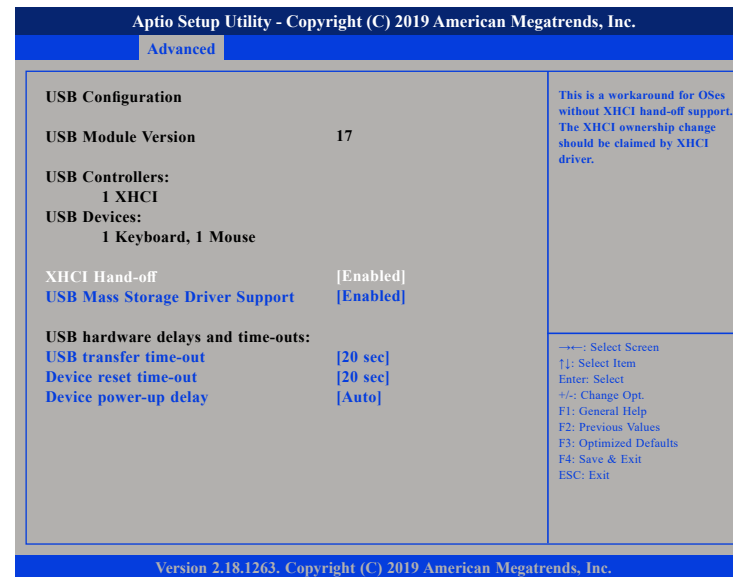

### XHCI Hand-off

This is a workaround for OSs that does not support XHCI hand-off. The XHCI ownership change should be claimed by the XHCI driver respectively.

### USB Mass Storage Driver Support

Enables or disables USB mass storage driver support.

### USB transfer time-out

The time-out value for control, bulk, and Interrupt transfers.

### Device reset time-out

Selects the USB mass storage device's start unit command timeout.

### Device power-up delay

Maximum time the value will take before it properly reports itself to the Host Controller. "Auto" uses default value: for a Root port it is 100 ms, for a Hub port the delay is taken from Hub descriptor.

## Chipset

This section gives you functions to configure the system based on the specific features of the chipset. The chipset manages bus speeds and access to system memory resources.



### South Bridge

Enters the South Bridge submenu.

### South Cluster Configuration

Enters the South Cluster Configuration submenu.

## South Bridge

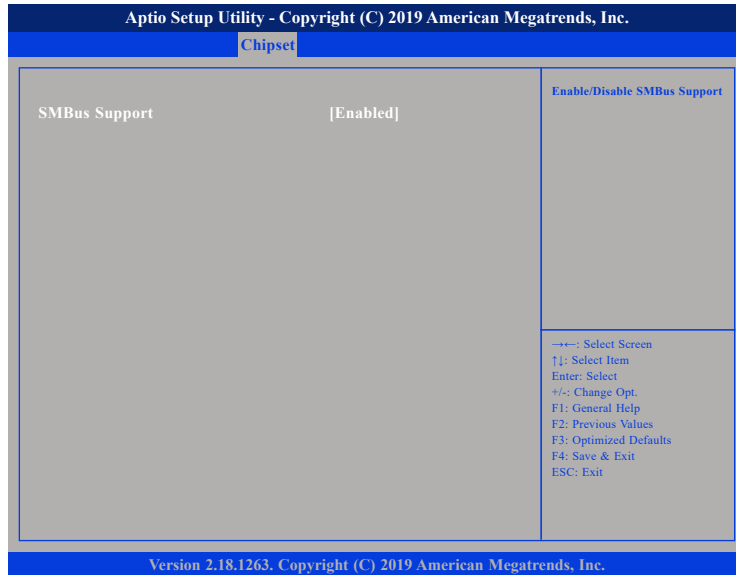

### SMBus Support

Enables or disables SMBus support.

## South Cluster Configuration



### HD-Audio Configuration

Enters the HD-Audio Configuration submenu.

### SATA Drives

Enters the SATA Drives submenu.

### USB Configuration

Enters the USB Configuration submenu.

## HD-Audio Configuration

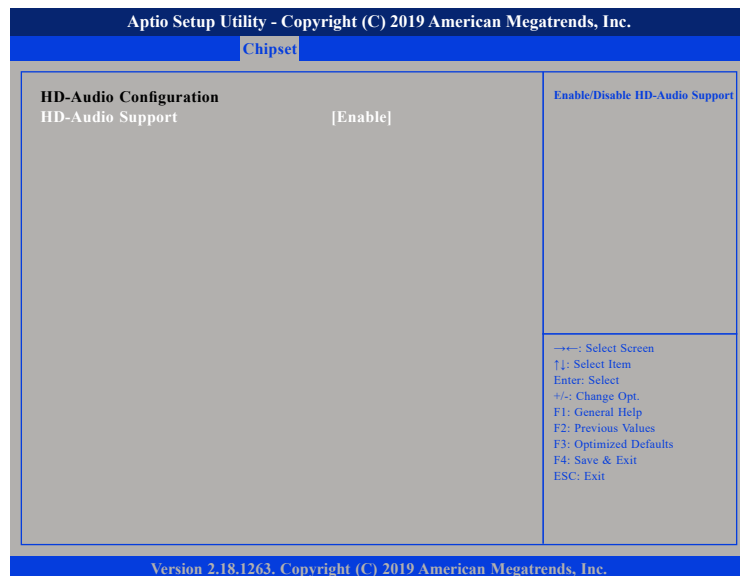

### HD-Audio Support

Enables or disables HD-Audio support.

## SATA Drives

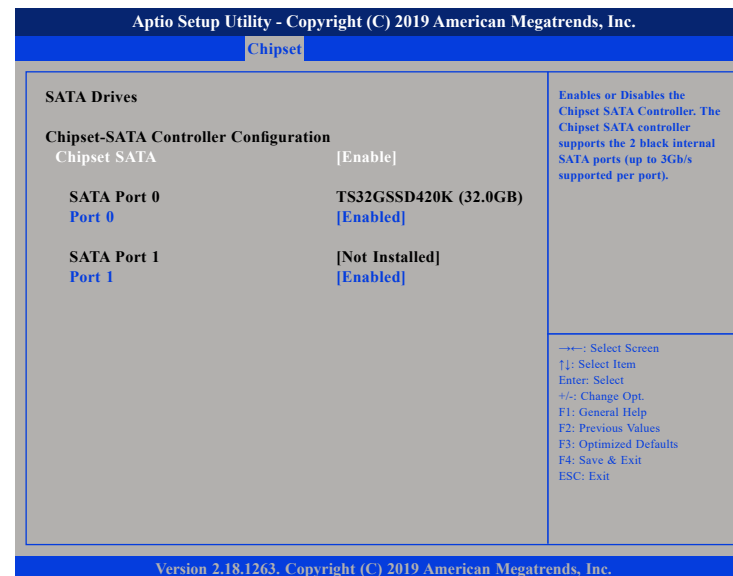

### Chipset SATA

Enables or disables the chipset SATA controller.

### Port 0 and Port 1

Enables or disables SATA port 0 and SATA port 1.

## USB Configuration



### xHCI Mode

Enables or disables XHCI mode. When enabled, XHCI controller would be disabled and none of the USB devices are detectable and usable during boot and in OS. Do not disable it unless for debugging purposes.

## Security

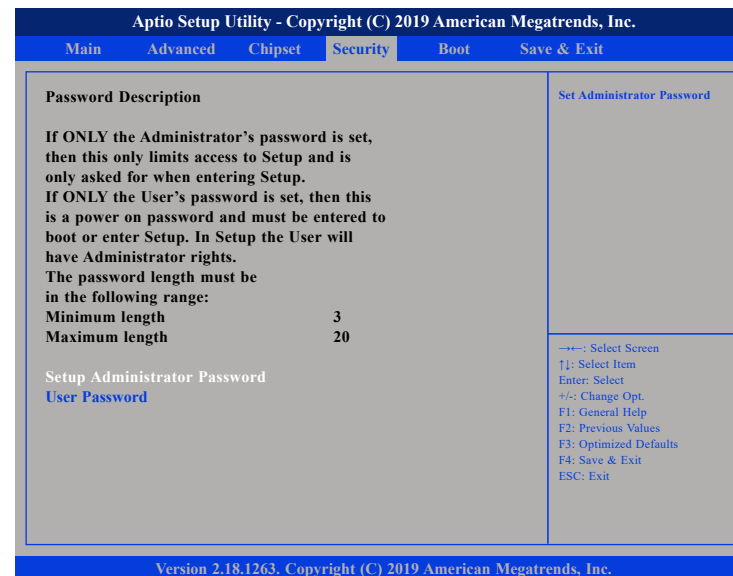

### Setup Administrator Password

Select this to reconfigure the administrator's password.

### User Password

Select this to reconfigure the user's password.



## Boot

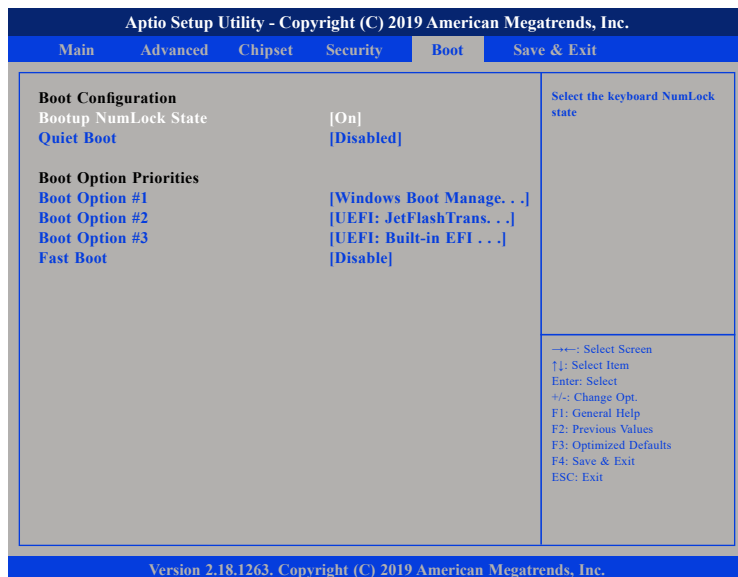

### Bootup NumLock State

This allows you to determine the default state of the numeric keypad. By default, the system boots up with NumLock on wherein the function of the numeric keypad is the number keys. When set to Off, the function of the numeric keypad is the arrow keys.

### Quiet Boot

Enabled            Displays OEM logo instead of the POST messages.  
 Disabled          Displays normal POST messages.

### Boot Option Priorities

Adjust the boot sequence of the system. Boot Option #1 is the first boot device that the system will boot from, next will be #2 and so forth.

### Fast Boot

When enabled, the BIOS will shorten or skip some check items during POST. This will decrease the time needed to boot the system.

## Save & Exit



### Save Changes and Reset

To save the changes and reset, select this field then press <Enter>. A dialog box will appear. Confirm by selecting Yes.

### Discard Changes and Reset

To exit the Setup utility and reset without saving the changes, select this field then press <Enter>. You may be prompted to confirm again before exiting.

### Restore Defaults

To restore the BIOS to default settings, select this field then press <Enter>. A dialog box will appear. Confirm by selecting Yes.