



NEXCOM International Co., Ltd.

Intelligent Platform & Services Business Unit

Fanless Embedded Computer

NDiS B338-LITE

User Manual

CONTENTS

Preface

Copyright	iv
Disclaimer	iv
Acknowledgements	iv
Regulatory Compliance Statements	iv
Declaration of Conformity	iv
RoHS Compliance	v
Warranty and RMA	vi
Safety Information	viii
Installation Recommendations	viii
Safety Precautions	ix
Technical Support and Assistance	x
Conventions Used in this Manual	x
Global Service Contact Information	xi
Package Contents	xiii
Ordering Information	xiv

Chapter 1: Product Introduction

Overview	1
Key Features	1
Physical Features	2
Front Panel	2
Rear Panel	2
Hardware Specifications	3
Mechanical Dimensions	4

Chapter 2: Jumpers and Connectors

Before You Begin	5
Precautions	5
Jumper Settings	6
Locations of the Jumpers and Connectors for NDiS B338-LITE	7
Top View	7
Bottom View	8
Jumpers & DIP Switches	9
COM2 RI Select	9
COM2 RI Select	9
Clear CMOS	10
Connector Pin Definitions	11
Internal Connectors	11
Battery connector	11
GPIO Connector	11
M.2 Key B Connector (3052)	12
M.2 Key M Connector (2280)	13
Mini PCIe / mSATA Slot	14
System Reset Button	15
Speaker Connector	15
USB2.0 x2 Connector	16
External I/O Interfaces	17
COM Connectors	17
DC Power Input Jack (+12V only)	17
HDMI Connectors	18



LAN Connector	18
Mic-In (Pink) and Line-Out (Green) Connector	19
USB3.2 Gen 1/2.0 Combo Connectors	19
USB2.0 Connectors	20
Block Diagram	21

Chapter 3: System Setup

Removing the Chassis Cover	22
Installing a SO-DIMM 1 Memory Module	23
Installing a SO-DIMM 2 Memory Module	25
Installing a LTE/5G Module (Key B 3052)	26
Installing an M.2 Storage Module (Key M 2280).....	27
Installing a WiFi Module (Mini-PCIe Slot)	28
Wall mounting instructio.....	29

Chapter 4: BIOS Setup

About BIOS Setup	30
When to Configure the BIOS.....	30
Default Configuration	31

Entering Setup	31
Legends	31
BIOS Setup Utility	33
Main	33
Advanced	34
截圖有錯	43
Security	44
Boot	44
Save & Exit	45

PREFACE

Copyright

This publication, including all photographs, illustrations and software, is protected under international copyright laws, with all rights reserved. No part of this manual may be reproduced, copied, translated or transmitted in any form or by any means without the prior written consent from NEXCOM International Co., Ltd.

Disclaimer

The information in this document is subject to change without prior notice and does not represent commitment from NEXCOM International Co., Ltd. However, users may update their knowledge of any product in use by constantly checking its manual posted on our website: <http://www.nexcom.com>. NEXCOM shall not be liable for direct, indirect, special, incidental, or consequential damages arising out of the use of any product, nor for any infringements upon the rights of third parties, which may result from such use. Any implied warranties of merchantability or fitness for any particular purpose is also disclaimed.

Acknowledgements

NDiS B338-LITE is a trademark of NEXCOM International Co., Ltd. All other product names mentioned herein are registered trademarks of their respective owners.

Regulatory Compliance Statements

This section provides the FCC compliance statement for Class A devices and describes how to keep the system CE compliant.

Declaration of Conformity

FCC

This equipment has been tested and verified to comply with the limits for a Class A digital device, pursuant to Part 15 of FCC Rules. These limits are designed to provide reasonable protection against harmful interference when the equipment is operated in a commercial environment. This equipment generates, uses, and can radiate radio frequency energy and, if not installed and used in accordance with the instructions, may cause harmful interference to radio communications. Operation of this equipment in a residential area (domestic environment) is likely to cause harmful interference, in which case the user will be required to correct the interference (take adequate measures) at their own expense.

CE

The product(s) described in this manual complies with all applicable European Union (CE) directives if it has a CE marking. For computer systems to remain CE compliant, only CE-compliant parts may be used. Maintaining CE compliance also requires proper cable and cabling techniques.

RoHS Compliance



NEXCOM RoHS Environmental Policy and Status Update

NEXCOM is a global citizen for building the digital infrastructure. We are committed to providing green products and services, which are compliant with European Union RoHS (Restriction on Use of Hazardous Substance in Electronic Equipment) directive 2011/65/EU, to be your trusted green partner and to protect our environment.

RoHS restricts the use of Lead (Pb) < 0.1% or 1,000ppm, Mercury (Hg) < 0.1% or 1,000ppm, Cadmium (Cd) < 0.01% or 100ppm, Hexavalent Chromium (Cr6+) < 0.1% or 1,000ppm, Polybrominated biphenyls (PBB) < 0.1% or 1,000ppm, and Polybrominated diphenyl Ethers (PBDE) < 0.1% or 1,000ppm.

In order to meet the RoHS compliant directives, NEXCOM has established an engineering and manufacturing task force to implement the introduction of green products. The task force will ensure that we follow the standard NEXCOM development procedure and that all the new RoHS components and new manufacturing processes maintain the highest industry quality levels for which NEXCOM are renowned.

The model selection criteria will be based on market demand. Vendors and suppliers will ensure that all designed components will be RoHS compliant.

How to recognize NEXCOM RoHS Products?

For existing products where there are non-RoHS and RoHS versions, the suffix "(LF)" will be added to the compliant product name.

All new product models launched after January 2013 will be RoHS compliant. They will use the usual NEXCOM naming convention.

Warranty and RMA

NEXCOM Warranty Period

NEXCOM manufactures products that are new or equivalent to new in accordance with industry standard. NEXCOM warrants that products will be free from defect in material and workmanship for 2 years, beginning on the date of invoice by NEXCOM. HCP series products (Blade Server) which are manufactured by NEXCOM are covered by a three year warranty period.

NEXCOM Return Merchandise Authorization (RMA)

- Customers shall enclose the “NEXCOM RMA Service Form” with the returned packages.
- Customers must collect all the information about the problems encountered and note anything abnormal or, print out any on-screen messages, and describe the problems on the “NEXCOM RMA Service Form” for the RMA number apply process.
- Customers can send back the faulty products with or without accessories (manuals, cable, etc.) and any components from the card, such as CPU and RAM. If the components were suspected as part of the problems, please note clearly which components are included. Otherwise, NEXCOM is not responsible for the devices/parts.
- Customers are responsible for the safe packaging of defective products, making sure it is durable enough to be resistant against further damage and deterioration during transportation. In case of damages occurred during transportation, the repair is treated as “Out of Warranty.”
- Any products returned by NEXCOM to other locations besides the customers’ site will bear an extra charge and will be billed to the customer.

Repair Service Charges for Out-of-Warranty Products

NEXCOM will charge for out-of-warranty products in two categories, one is basic diagnostic fee and another is component (product) fee.

Repair Service Charges for Out-of-Warranty Products

NEXCOM will charge for out-of-warranty products in two categories, one is basic diagnostic fee and another is component (product) fee.

System Level

- Component fee: NEXCOM will only charge for main components such as SMD chip, BGA chip, etc. Passive components will be repaired for free, ex: resistor, capacitor.
- Items will be replaced with NEXCOM products if the original one cannot be repaired. Ex: motherboard, power supply, etc.
- Replace with 3rd party products if needed.
- If RMA goods can not be repaired, NEXCOM will return it to the customer without any charge.

Board Level

- Component fee: NEXCOM will only charge for main components, such as SMD chip, BGA chip, etc. Passive components will be repaired for free, ex: resistors, capacitors.
- If RMA goods can not be repaired, NEXCOM will return it to the customer without any charge.

Warnings

Read and adhere to all warnings, cautions, and notices in this guide and the documentation supplied with the chassis, power supply, and accessory modules. If the instructions for the chassis and power supply are inconsistent with these instructions or the instructions for accessory modules, contact the supplier to find out how you can ensure that your computer meets safety and regulatory requirements.

Cautions

Electrostatic discharge (ESD) can damage system components. Do the described procedures only at an ESD workstation. If no such station is available, you can provide some ESD protection by wearing an antistatic wrist strap and attaching it to a metal part of the computer chassis.

Safety Information

Before installing and using the device, note the following precautions:

- Read all instructions carefully.
- Do not place the unit on an unstable surface, cart, or stand.
- Follow all warnings and cautions in this manual.
- When replacing parts, ensure that your service technician uses parts specified by the manufacturer.
- Avoid using the system near water, in direct sunlight, or near a heating device.
- The load of the system unit does not solely rely for support from the rackmounts located on the sides. Firm support from the bottom is highly necessary in order to provide balance stability.
- The computer is provided with a battery-powered real-time clock circuit. There is a danger of explosion if battery is incorrectly replaced. Replace only with the same or equivalent type recommended by the manufacturer. Discard used batteries according to the manufacturer's instructions.

Installation Recommendations

Ensure you have a stable, clean working environment. Dust and dirt can get into components and cause a malfunction. Use containers to keep small components separated.

Adequate lighting and proper tools can prevent you from accidentally damaging the internal components. Most of the procedures that follow require only a few simple tools, including the following:

- A Philips screwdriver
- A flat-tipped screwdriver
- A grounding strap
- An anti-static pad

Using your fingers can disconnect most of the connections. It is recommended that you do not use needle-nose pliers to disconnect connections as these can damage the soft metal or plastic parts of the connectors.

Safety Precautions

1. Read these safety instructions carefully.
2. Keep this User Manual for later reference.
3. Disconnect this equipment from any AC outlet before cleaning. Use a damp cloth. Do not use liquid or spray detergents for cleaning.
4. For plug-in equipment, the power outlet socket must be located near the equipment and must be easily accessible.
5. Keep this equipment away from humidity.
6. Put this equipment on a stable surface during installation. Dropping it or letting it fall may cause damage.
7. The openings on the enclosure are for air convection to protect the equipment from overheating. **DO NOT COVER THE OPENINGS.**
8. Make sure the voltage of the power source is correct before connecting the equipment to the power outlet.
9. Place the power cord in a way so that people will not step on it. Do not place anything on top of the power cord. Use a power cord that has been approved for use with the product and that it matches the voltage and current marked on the product's electrical range label. The voltage and current rating of the cord must be greater than the voltage and current rating marked on the product.
10. All cautions and warnings on the equipment should be noted.
11. If the equipment is not used for a long time, disconnect it from the power source to avoid damage by transient overvoltage.
12. Never pour any liquid into an opening. This may cause fire or electrical shock.
13. Never open the equipment. For safety reasons, the equipment should be opened only by qualified service personnel.
14. If one of the following situations arises, get the equipment checked by service personnel:
 - a. The power cord or plug is damaged.
 - b. Liquid has penetrated into the equipment.
 - c. The equipment has been exposed to moisture.
 - d. The equipment does not work well, or you cannot get it to work according to the user's manual.
 - e. The equipment has been dropped and damaged.
 - f. The equipment has obvious signs of breakage.
15. Do not place heavy objects on the equipment.
16. The unit uses a three-wire ground cable which is equipped with a third pin to ground the unit and prevent electric shock. Do not defeat the purpose of this pin. If your outlet does not support this kind of plug, contact your electrician to replace your obsolete outlet.
17. **CAUTION: DANGER OF EXPLOSION IF BATTERY IS INCORRECTLY REPLACED. REPLACE ONLY WITH THE SAME OR EQUIVALENT TYPE RECOMMENDED BY THE MANUFACTURER. DISCARD USED BATTERIES ACCORDING TO THE MANUFACTURER'S INSTRUCTIONS.**

Technical Support and Assistance

1. For the most updated information of NEXCOM products, visit NEXCOM's website at www.nexcom.com.
2. For technical issues that require contacting our technical support team or sales representative, please have the following information ready before calling:
 - Product name and serial number
 - Detailed information of the peripheral devices
 - Detailed information of the installed software (operating system, version, application software, etc.)
 - A complete description of the problem
 - The exact wordings of the error messages

Warning!

1. Handling the unit: carry the unit with both hands and handle it with care.
2. Maintenance: to keep the unit clean, use only approved cleaning products or clean with a dry cloth.

Conventions Used in this Manual



Warning:

Information about certain situations, which if not observed, can cause personal injury. This will prevent injury to yourself when performing a task.



Caution:

Information to avoid damaging components or losing data.



Note:

Provides additional information to complete a task easily.

Global Service Contact Information

Headquarters

NEXCOM International Co., Ltd.

9F, No. 920, Zhongzheng Rd.,
Zhonghe District, New Taipei City, 23586,
Taiwan, R.O.C.
Tel: +886-2-8226-7786
Fax: +886-2-8226-7782
www.nexcom.com

Asia

Taiwan

NexAIoT Headquarters

Industry 4.0 and Cloud Services

12F, No.922, Zhongzheng Rd.,
Zhonghe Dist., New Taipei City,
23586, Taiwan, R.O.C.
Tel: +886-2-8226-7796
Fax: +886-2-8226-7926
Email: sales@nexaiot.com
www.nexaiot.com

NexAIoT Co., Ltd.

Taichung Office

16F, No.250, Sec.2, Chongde Rd.,
Beitun District,
Taichung City, 406, Taiwan, R.O.C.
Tel: +886-4-2249-1179
Fax: +886-4-2249-1172
Email: jacobhuang@nexaiot.com
www.nexaiot.com

NexCOBOT Taiwan Co., Ltd.

13F, No.916, Zhongzheng Rd.,
Zhonghe District,
New Taipei City, 23586, Taiwan, R.O.C.
Tel: +886-2-8226-7786
Fax: +886-2-8226-7926
Email: jennyshern@nexcobot.com
www.nexcobot.com

GreenBase Technology Corp.

13F, No.922, Zhongzheng Rd.,
Zhonghe District,
New Taipei City, 23586, Taiwan, R.O.C.
Tel: +886-2-8226-7786
Fax: +886-2-8226-7900
Email: vivianlin@nexcom.com.tw
www.nexcom.com.tw

DivioTec Inc.

19F-1A, No.97, Sec.4, ChongXin Rd.,
Sanhong District,
New Taipei City, 24161, Taiwan, R.O.C.
Tel: +886-2-8976-3077
Email: sales@diviotec.com
www.diviotec.com

AIoT Cloud Corp.

13F, No.922, Zhongzheng Rd.,
Zhonghe District,
New Taipei City, 23586, Taiwan, R.O.C.
Tel: +886-2-8226-7786
Fax: +886-2-8226-7782
Email: alantsai@aiotcloud.net
www.aiotcloud.dev

EMBUX TECHNOLOGY CO., LTD.

13F, No.916, Zhongzheng Rd.,
Zhonghe District,
New Taipei City, 23586, Taiwan, R.O.C.
Tel: +886-2-8226-7786
Fax: +886-2-8226-7782
Email: info@embux.com
www.embux.com

TMR TECHNOLOGIES CO., LTD.

13F, No.916, Zhongzheng Rd.,
Zhonghe District,
New Taipei City, 23586, Taiwan, R.O.C.
Tel: +886-2-8226-7786
Fax: +886-2-8226-7782
Email: services@tmrtek.com
www.tmrtek.com

China NEXSEC Incorporated

201, Floor 2, Unit 2, Building 15, Yard 3,
Gaolizhang Road, Haidian District,
Beijing, 100094, China
Tel: +86-10-5704-2680
Fax: +86-10-5704-2681
Email: marketing@nexsec.cn
www.nexsec.cn

NEXCOM Shanghai

Room 406-407, Building C, No 154, Lane 953,
Jianchuan Road, Minhang District,
Shanghai, 201108, China
Tel: +86-21-5278-5868
Fax: +86-21-3251-6358
Email: sales@nexcom.cn
www.nexcom.cn

NEXCOM Surveillance Technology Corp.

Floor 8, Building B3, Xiufeng Industrial Zone,
GanKeng Community, Buji Street,
LongGang District,
ShenZhen, 518112, China
Tel: +86-755-8364-7768
Fax: +86-755-8364-7738
Email: steveyang@nexcom.com.tw
www.nexcom.cn

NEXGOL Chongqing

1st Building No.999,
Star Boulevard, Yongchuan Dist,
Chongqing City, 402160, China
Tel: +86-23-4960-9080
Fax: +86-23-4966-5855
Email: sales@nexgol.com.cn
www.nexcom.cn

Beijing NexGemo Technology Co.,Ltd.

Room 205, No.1, Fazhan Road.,
Beijing International Information Industry Base,
Changping District,
Beijing, 102206, China
Tel: +86-10-8072-2025
Fax: +86-10-8072-2022
Email: sales@nexgemo.cn
www.nexgemo.cn

Japan

NEXCOM Japan

9F, Tamachi Hara Bldg.,
4-11-5, Shiba Minato-ku,
Tokyo, 108-0014, Japan
Tel: +81-3-5419-7830
Fax: +81-3-5419-7832
Email: sales@nexcom-jp.com
www.nexcom-jp.com

America

USA NEXCOM USA

46665 Fremont Blvd.,
Fremont CA 94538, USA
Tel: +1-510-656-2248
Fax: +1-510-656-2158
Email: sales@nexcom.com
www.nexcomusa.com

Package Contents

Before continuing, verify that the NDiS B338-LITE package that you received is complete. Your package should have all the items listed in the following table.

Item	Part Number	Name	Qty
1	10W00B33802X0	NDiS B338-LITE	1
2	7400060049X00	Power Adapter FSP:FSP060-DHAN3	1
3	5060200719X00	THERMAL PAD T-GLOBAL 65x20x1.0mm FOR BOTTOM RAM	1
4	5060200781X00	THERMAL PAD T-GLOBAL 60x20x2.5mm FOR TOP RAM	1
5	5060200782X00	THERMAL PAD T-GLOBAL 60x20x3.5mm FOR TOP M.2(Transcend) Note: Due to different module with different height, please choose an appropriate thermal pad.	1
6	5060200720X00	THERMAL PAD T-GLOBAL 60x20x3.0mm FOR TOP M.2(Apacer/InnoDisk) Note: Due to different module with different height, please choose an appropriate thermal pad.	1
7	5060200783X00	THERMAL PAD T-GLOBAL 30x30x2.5mm FOR WIFI/LTE MODULE	2

Ordering Information

The following information below provides ordering information for NDiS B338-LITE.

NDiS B338-LITE (P/N: 10W00B33802X0)

Intel® Celeron® J6412 processor slim and fanless system.

CHAPTER 1: PRODUCT INTRODUCTION

Overview



The NDiS B338-LITE fanless embedded system is powered by an Intel® Celeron® processor and is capable of handling two independent display outputs. It supports up to 2x HDMI 2.0 outputs, USB 3.0 ports, and two RS232 interfaces. This makes it an ideal choice for optimizing information visualization, conveying brand messages, improving customer engagement, and increasing smart retail management efficiencies. Moreover, it can be utilized as a gateway for smart city applications.

The NDiS B338-LITE is a slim-type fanless embedded system with extended temperature durability, making it suitable for outdoor usage in locations such as QSR drive-through kiosks, information stands, bus stops, or digital transit information signs. It is also an excellent IoT device which is extensively used in surveillance and security applications, providing real-time monitoring, object detection, and facial recognition in areas such as airports, public spaces, and smart infrastructure.

Key Features

- Intel® Celeron® J6412 processor
- Supports 2 x HDMI 1.4 output
- Supports 12V DC input
- Compact and slim design (H: 38.8mm)
- 2 x DDR4 up to 32G
- 1 x M.2 2280 Key M for optional storage device
- 1 x M.2 3052 Key B for optional LTE or 5G modules
- 1 x mini-PCIe for optional Wi-Fi or LTE
- Fanless design

Physical Features

Front Panel

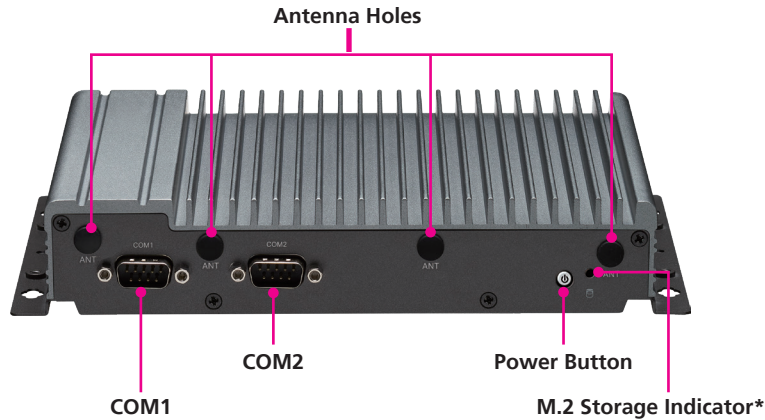

Rear Panel

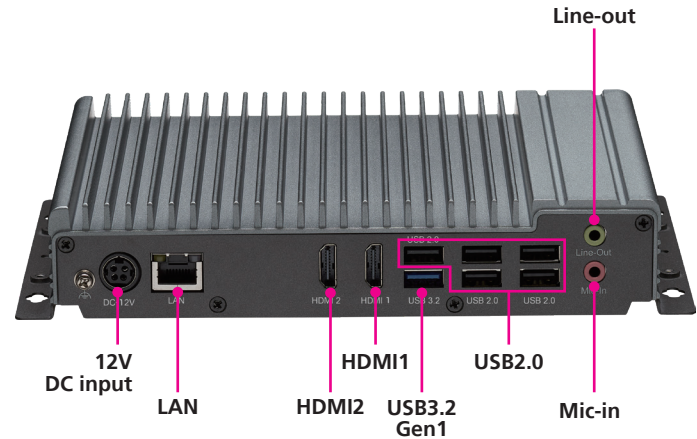

This indicator flashes when data is being transmitted using an M.2 storage device. Note that this indicator will not function when the system is using an mSATA storage device.

Hardware Specifications

CPU Support

- Intel® Celeron® J6412 processor, 10W

Graphics

- Intel® UHD graphics

Main Memory

- 2 x 260-pin SO-DIMM sockets, supports DDR4 3200MT/s MHz, Non ECC, un-buffered memory up to 32G (single socket max. 16GB)

I/O Interface-Front

- Power button with LED
- 2 x COM port
 - COM1 / COM2: RS232
- 4 x Antenna holes

I/O Interface-Rear

- 2 x HDMI 1.4
- 1 x RJ45 Gigabit LAN with LEDs
- 1 x USB 3.2 Gen 1
- 5 x USB 2.0
- 1 x Mic in
- 1 x Line out
- 12V DC input

Internal I/O

- 8 x GPIO (4 x GPI, 4 x GPO)
- TPM 2.0 onboard
- 1 x USB 2.0 pin header
- 1 x Speaker-out pin header with 2.5W/8Ω amplifier

Storage

- 1 x M.2 2280 Key M (PCIe Gen3 x2 / SATA) for optional storage modules

Expansion

- 1 x M.2 3052 Key B (PCIe Gen3x1, USB 3.1, USB 2.0) for optional LTE or 5G modules
- 1 x mini-PCIe slot (USB 2.0, PCIe/SATA) for optional Wi-Fi or LTE
- 1 x SIM slot

Power Supply

- 1 x External 60W AC/DC power adapter
- Input: 100VAC to 240VAC
- Output: DC+12VDC

Environment

- Operating temperature: -20°C to 60°C w/ 0.7 airflow
- Storage temperature: -20°C to 80°C
- Humidity: 95% (non-condensing)

Dimensions

- 224mm (W) x 150mm (D) x 39.8mm (H) (with wall mount bracket)

Certification

- CE
- FCC Class A

Operating System

- Win10 / Win11 64-bit / Linux

Mechanical Dimensions

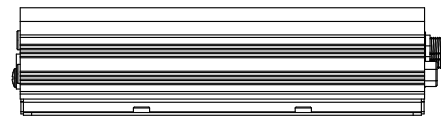
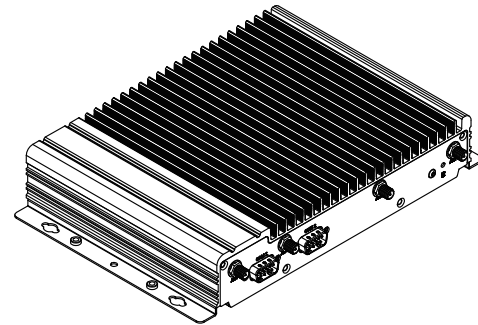
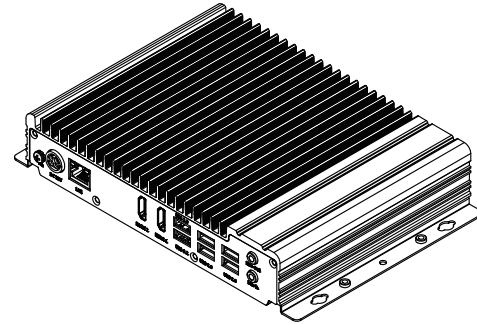
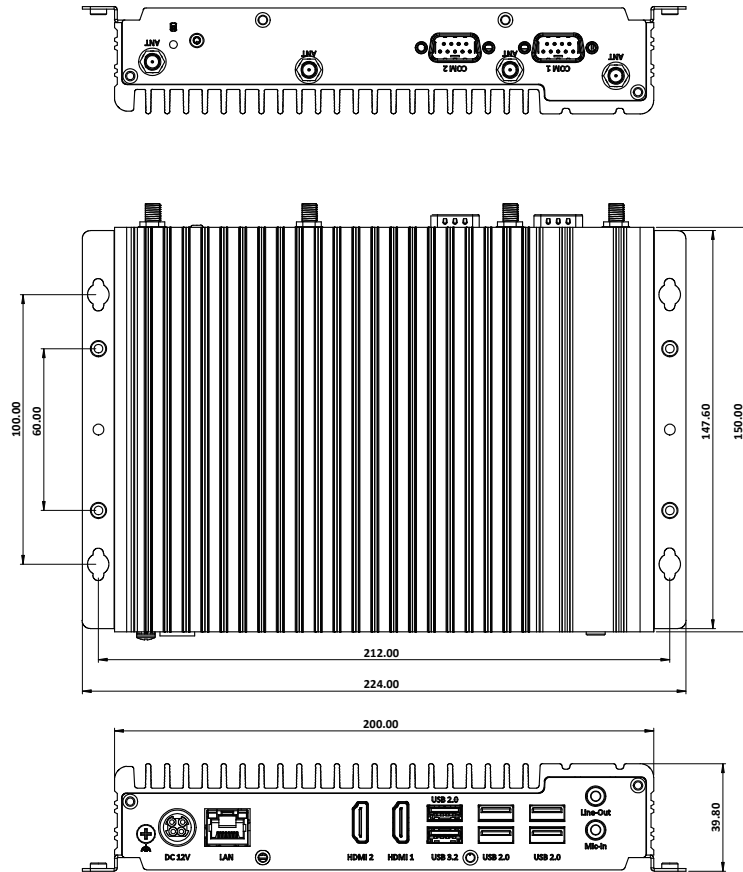

CHAPTER 2: JUMPERS AND CONNECTORS

This chapter describes how to set the jumpers and connectors on the NDiS B338-LITE motherboard.

Before You Begin

- Ensure you have a stable, clean working environment. Dust and dirt can get into components and cause a malfunction. Use containers to keep small components separated.
- Adequate lighting and proper tools can prevent you from accidentally damaging the internal components. Most of the procedures that follow require only a few simple tools, including the following:
 - A Philips screwdriver
 - A flat-tipped screwdriver
 - A set of jewelers screwdrivers
 - A grounding strap
 - An anti-static pad
- Using your fingers can disconnect most of the connections. It is recommended that you do not use needle-nosed pliers to disconnect connections as these can damage the soft metal or plastic parts of the connectors.
- Before working on internal components, make sure that the power is off. Ground yourself before touching any internal components, by touching a metal object. Static electricity can damage many of the electronic components. Humid environments tend to have less static electricity than

dry environments. A grounding strap is warranted whenever danger of static electricity exists.

Precautions

Computer components and electronic circuit boards can be damaged by discharges of static electricity. Working on computers that are still connected to a power supply can be extremely dangerous.

Follow the guidelines below to avoid damage to your computer or yourself:

- Always disconnect the unit from the power outlet whenever you are working inside the case.
- If possible, wear a grounded wrist strap when you are working inside the computer case. Alternatively, discharge any static electricity by touching the bare metal chassis of the unit case, or the bare metal body of any other grounded appliance.
- Hold electronic circuit boards by the edges only. Do not touch the components on the board unless it is necessary to do so. Don't flex or stress the circuit board.
- Leave all components inside the static-proof packaging that they shipped with until they are ready for installation.
- Use correct screws and do not over tighten screws.

Jumper Settings

A jumper is the simplest kind of electric switch. It consists of two metal pins and a cap. When setting the jumpers, ensure that the jumper caps are placed on the correct pins. When the jumper cap is placed on both pins, the jumper is short. If you remove the jumper cap, or place the jumper cap on just one pin, the jumper is open.

Refer to the illustrations below for examples of what the 2-pin and 3-pin jumpers look like when they are short (on) and open (off).

Two-Pin Jumpers: Open (Left) and Short (Right)

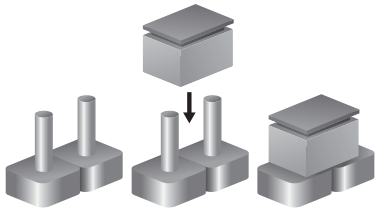

Three-Pin Jumpers: Pins 1 and 2 are Short

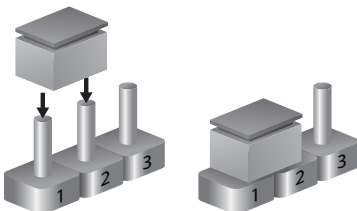

Locations of the Jumpers and Connectors for NDiS B338-LITE

The figure below is the top view of the mainboard used in the NDiS B338-LITE, and indicate the locations of the jumpers and connectors. Refer to this chapter for detailed pin settings and definitions of the connectors marked in pink on this figure.

Top View

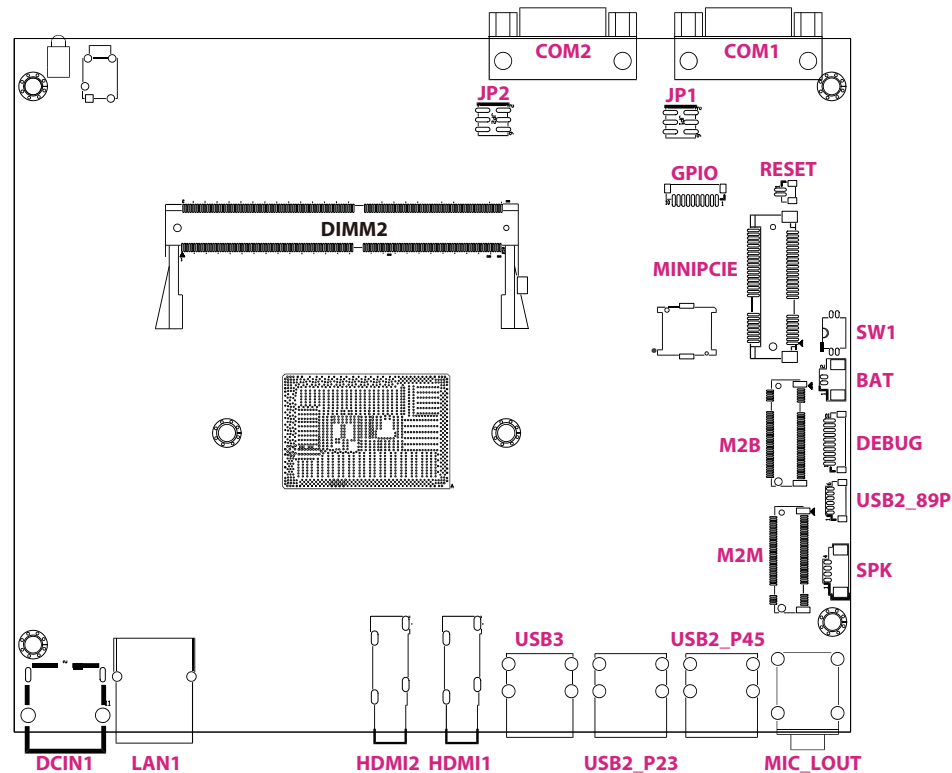

Bottom View

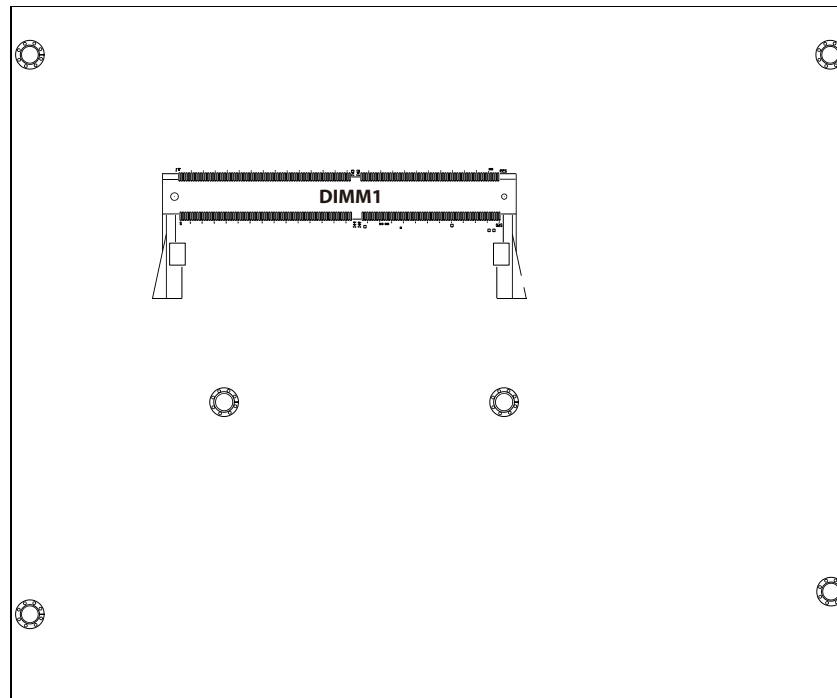

Jumpers & DIP Switches

COM2 RI Select

Connector type: PIN-M-180-2.0mm
 Connector location: JP1



Pin	Settings
1	VCC5
2	COM1RI_SEL
3	COM1RI
4	COM1RI_SEL
5	VCC12
6	COM1RI_SEL

] Default

COM2 RI Select

Connector type: PIN-M-180-2.0mm, S/T
 Connector location: JP2

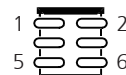

Pin	Settings
1	VCC5
2	COM2RI_SEL
3	COM2RI
4	COM2RI_SEL
5	VCC12
6	COM2RI_SEL

] Default

Clear CMOS

Connector type: 2x2 DIP SWITCH HCH: HPS602-E

Connector location: SW1

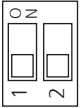

Pin	Position	Function
1	OFF	Normal (default)
2	OFF	Normal (default)
1	ON	Clear ME
2	ON	Clear CMOS

Connector Pin Definitions

Internal Connectors

Battery connector

Connector type: WtoB CON 2P, 1.25mm, R/A

Connector location: BAT

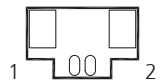

Pin	Definition
1	GND
2	BAT

GPIO Connector

Connector type: WtoB CON 10P, 1.0mm, S/T

Connector location: GPIO

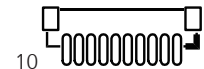

Pin	Definition	Pin	Definition
1	+5V	2	GND
3	GPO0	4	GPO1
5	GPO2	6	GPO3
7	GPIO	8	GPI1
9	GPI2	10	GPI3

M.2 Key B Connector (3052)

Connector location: M2B

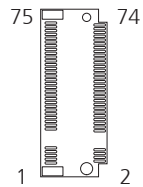

Pin	Definition	Pin	Definition
1	CONFIG3	2	3.3V
3	GND	4	3.3V
5	GND	6	POWER_OFF#
7	USB2_5P	8	WIFI_DIS#
9	USB2_5N	10	LED#
11	NC		
		20	Telit FN980 PCIe/USB Select Pin
21	CONFIG0	22	NC
23	NC	24	NC
25	NC	26	WWAN_GPS_ON
27	GND	28	NC
29	USB3_RXN	30	UIM_RESET
31	USB3_RXP	32	UIM_CLK
33	GND	34	UIM_DATA
35	USB3_TXN	36	UIM_PWR
37	USB3_TXP	38	NC
39	GND	40	NC

Pin	Definition	Pin	Definition
41	PCIEX_RXN	42	NC
43	PCIEX_RXP	44	NC
45	GND	46	NC
47	PCIEX_TXN	48	NC
49	PCIEX_TXP	50	RESET(3.3V)
51	GND	52	CLKREQ#
53	CLK_DN	54	WAKE#
55	CLK_DP	56	NC
57	GND	58	NC
59	NC	60	NC
61	NC	62	NC
63	NC	64	NC
65	NC	66	NC
67	RESET(1.8V)	68	SUS_CLK
69	CONFIG1	70	3.3V
71	GND	72	3.3V
73	GND	74	3.3V
75	CONFIG2		

M.2 Key M Connector (2280)

Connector location: M2M

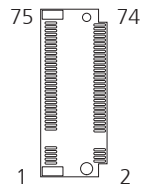

Pin	Definition	Pin	Definition
1	GND	2	VCC3
3	GND	4	VCC3
5	PCIE3_RXN	6	NC
7	PCIE3_RXP	8	NC
9	GND	10	M2M_LED#
11	PCIE3_TXN	12	VCC3
13	PCIE3_TXP	14	VCC3
15	GND	16	VCC3
17	PCIE2_RXN	18	VCC3
19	PCIE2_RXP	20	NC
21	GND	22	NC
23	PCIE2_TXN	24	NC
25	PCIE2_TXP	26	NC
27	GND	28	NC
29	PCIE1_RXN	30	NC
31	PCIE1_RXP	32	NC
33	GND	34	NC
35	PCIE1_TXN	36	NC

Pin	Definition	Pin	Definition
37	PCIE1_TXP	38	DEVSLP
39	GND	40	NC
41	SATA_RXP(PCIE0_RXP)	42	NC
43	SATA_RXN(PCIE0_RXN)	44	NC
45	GND	46	NC
47	SATA_TXN(PCIE0_TXN)	48	NC
49	SATA_TXP(PCIE0_TXP)	50	RESET#
51	GND	52	CLKREQ#
53	CLK_PCIEN	54	WAKE#
55	CLK_PCIEP	56	NC
57	GND	58	NC
67	NC	68	NC
69	M2M_PEDET	70	VCC3
71	GND	72	VCC3
73	GND	74	VCC3
75	GND		

Mini PCIe / mSATA Slot

Connector location: MINI PCIE

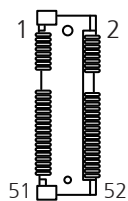

Pin	Definition	Pin	Definition
1	WAKE#	2	3.3V
3	NC	4	GND
5	NC	6	1.5V
7	CLKREQ#	8	UIM_PWR
9	GND	10	UIM_DATA
11	CLKNO	12	UIM_CLK
13	CLKPO	14	UIM_RESET
15	GND	16	UIM_VPP
17	NC	18	GND
19	NC	20	W_DIS#
21	GND	22	RESET#
23	PCIE5_RXN / SATA_RXP	24	3.3V
25	PCIE5_RXP / SATA_RXN	26	GND
27	GND	28	1.5V
29	GND	30	SMB_CLK
31	PCIE5_TXN / SATA_TXN	32	SMB_DATA
33	PCIE5_TXP / SATA_TXP	34	GND

Pin	Definition	Pin	Definition
35	GND	36	USB2_6DN
37	GND	38	USB2_6DP
39	3.3V	40	GND
41	3.3V	42	NC
43	GND	44	NC
45	NC	46	NC
47	NC	48	1.5V
49	NC	50	GND
51	mSATA Presece Detection	52	3.3V

System Reset Button

Connector type: Header 1X2P, 2.0mm, S/T

Connector location: RESET

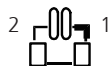

Pin	Definition
1	GND
2	RESET#

Speaker Connector

Connector type: WtoB CON 4P, 1.25mm, S/T

Connector location: SPK

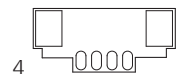

Pin	Definition
1	L_OUT+
2	L_OUT-
3	R_OUT+
4	R_OUT-

USB2.0 x2 Connector

Connector type: WtoB CON 6P, 1.0mm, S/T

Connector location: USB2_89P

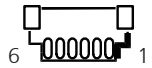

Pin	Definition
1	GND
2	USB2N
3	USB2P
4	USB1N
5	USB1P
6	+5V

External I/O Interfaces

COM Connectors

Connector type: SIO-M-90-2.77mm

Connector location: COM1, COM2 (RS232)

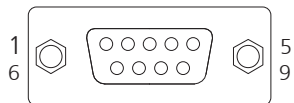

Pin	Definition
1	DCD#
2	RXD
3	TXD
4	DTR#
5	GND
6	DSR#
7	RTS#
8	CTS#
9	RI#

DC Power Input Jack (+12V only)

Connector location: DCIN1

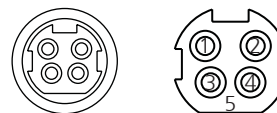

Pin	Definition
1	+12VSUS
2	+12VSUS
3	GND
4	GND
5	CGND

HDMI Connectors

Connector type: HDMI CON 19P G/F R/A SMT

Connector location: HDMI1, HDMI2

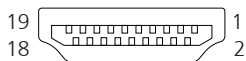

Pin	Definition	Pin	Definition
1	HDMI1_TX2P	2	GND
3	HDMI1_TX2N	4	HDMI1_TX1P
5	GND	6	HDMI1_TX1N
7	HDMI1_TX0P	8	GND
9	HDMI1_TX0N	10	HDMI1_CLK_P
11	GND	12	HDMI1_CLK_N
13	NC	14	NC
15	HDMI1_SCL	16	HDMI1_SDA
17	GND	18	HDMI1_P5V
19	HDMI1_HPD	MH1	CGND
MH2	CGND	MH3	CGND
MH4	CGND		

LAN Connector

Connector type: LAN JACK Single W/LED R/A DIP

Connector location: LAN1

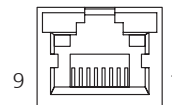

Speed	Act (Left)	Link (Right)
1G/2.5G	Blinking Yellow	Always On
100Mbps	Blinking Yellow	Always On
10Mbps	Blinking Yellow	Off
No Active	Off	Off

Pin	Definition	Pin	Definition
1	LAN1_MDI0P	2	LAN1_MDI0N
3	LAN1_MDI1P	4	LAN1_MDI1N
5	TCT	6	TCTG
7	LAN1_MDI2P	8	LAN1_MDI2N
9	LAN1_MDI3P	10	LAN1_MDI3N
11	LAN1_LED_ACT_POWER	12	LAN1_LED_ACT#
13	LAN1_LED_LINK2500#	14	LAN1_LED_LINK1000#
MH1	CGND	MH2	CGND

Mic-In (Pink) and Line-Out (Green) Connector

Connector type: Ear Phone Jack 2x1 Port

Connector location: MIC_LOUT



Pin	Definition	Pin	Definition
1	AUDGND	2	MIC_OUT-L
3	AUDGND	4	MIC_JD
5	MIC_OUT-R	22	LINE_OUT-L
23	AUDGND	24	LINE_JD
25	LINE_OUT-R	MH1	CGND
MH2	CGND	MH3	CGND
MH4	CGND		

USB3.2 Gen 1/2.0 Combo Connectors

Connector type: USB3.2 Gen 1(Lower) / 2.0 Combo (upper)

Connector location: USB3

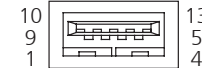
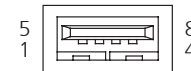

Pin	Definition	Pin	Definition
1	+5V	2	USB2_3N
3	USB2_3P	4	GND
5	USB3_RX3N	6	USB3_RX3P
7	GND	8	USB3_TX3N
9	USB3_TX3P	10	+5V
11	USB2_4N	12	USB2_4P
13	GND		
MH1	CGND	MH2	CGND
MH3	CGND	MH4	CGND

USB2.0 Connectors

Connector type: USB2.0 Dual CON

Connector location: USB2_P23, USB2_P45

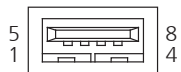

Pin	Definition	Pin	Definition
1	+5V	2	USB2_1N
3	USB2_1P	4	GND
5	+5V	6	USB2_2N
7	USB2_2P	8	GND
MH1	CGND	MH2	CGND
MH3	CGND	MH4	CGND

Block Diagram

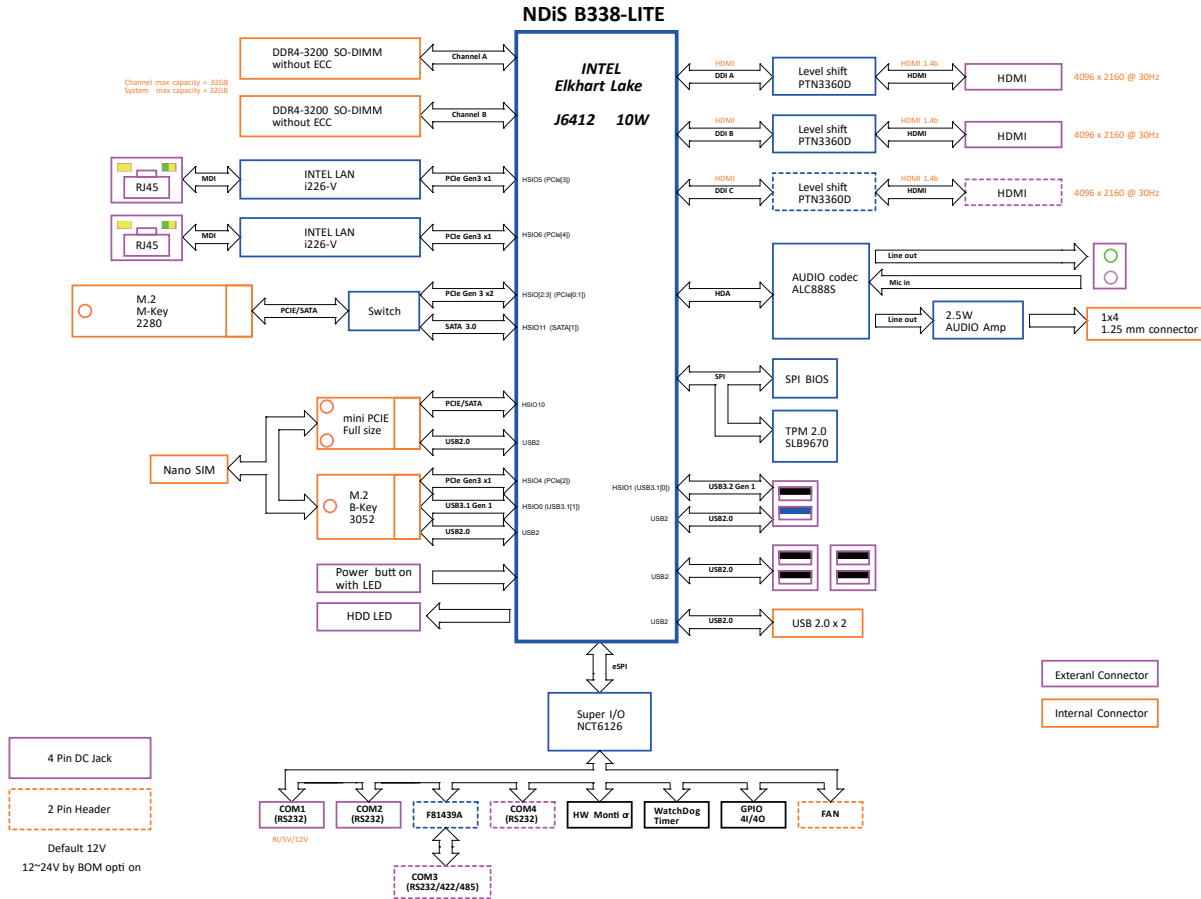

CHAPTER 3: SYSTEM SETUP

Removing the Chassis Cover



Prior to removing the chassis cover, make sure the unit's power is off and disconnected from the power sources to prevent electric shock or system damage.

1. Remove the mounting screws from the front and rear panel respectively.



2. Once the screws are removed, lift the cover up and out of the chassis.

Installing a SO-DIMM 1 Memory Module

1. Remove the two mounting screws from the bottom cover respectively.
2. Locate the SO-DIMM 1 socket on the mainboard.

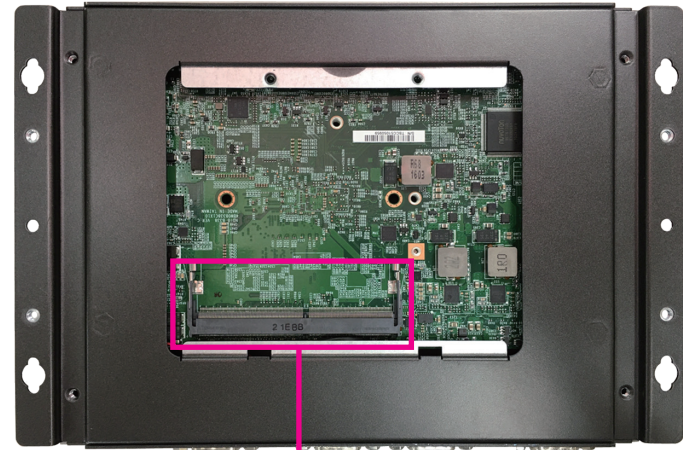
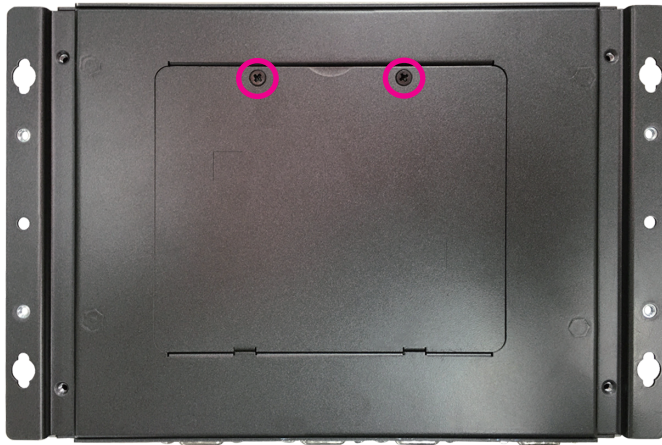

SO-DIMM 1 socket



There is no specific installation order when inserting the memory module. Users can install the memory in either DIMM 1 or DIMM 2 according to their requirements.

3. Insert the memory module into the socket at an approximately 30 degrees angle. The ejector tabs at the ends of the socket will automatically snap into the locked position to hold the module in place.

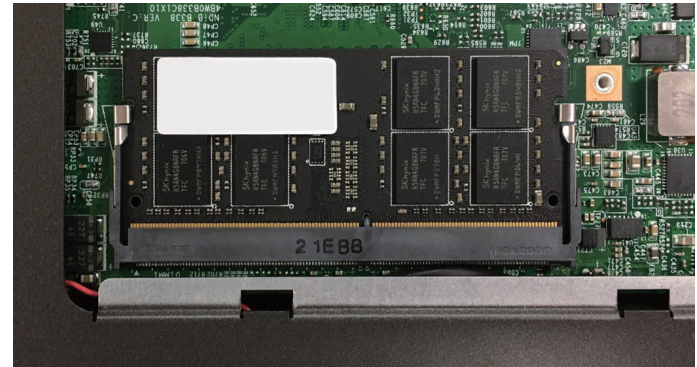
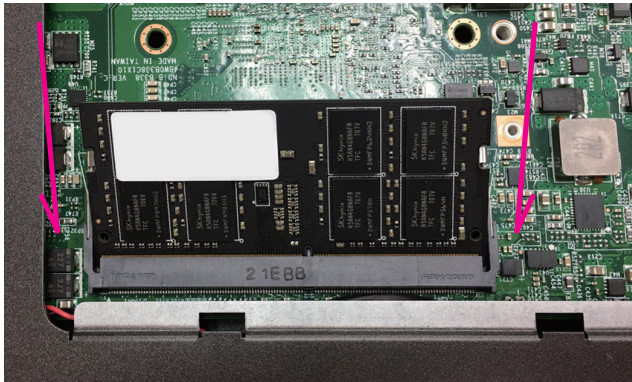

Installing a SO-DIMM 2 Memory Module

1. Locate the SO-DIMM 2 socket on the mainboard.

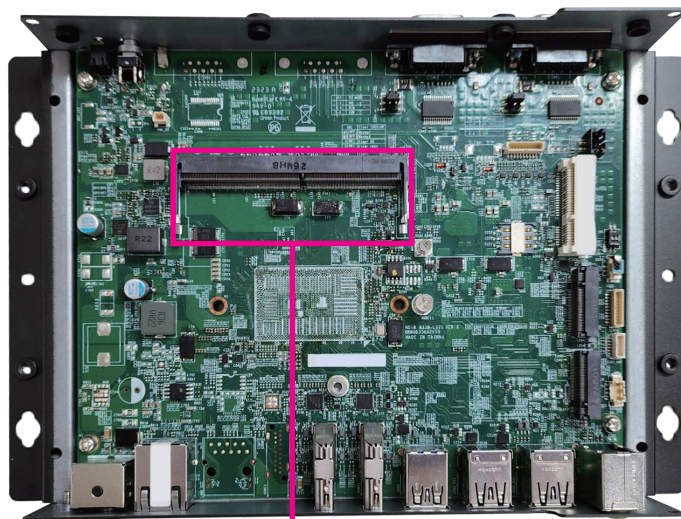

SO-DIMM 2 socket



There is no specific installation order when inserting the memory module. Users can install the memory in either DIMM 1 or DIMM 2 according to their requirements.

2. Insert the memory module into the socket at an approximately 30 degrees angle. The ejector tabs at the ends of the socket will automatically snap into the locked position to hold the module in place.

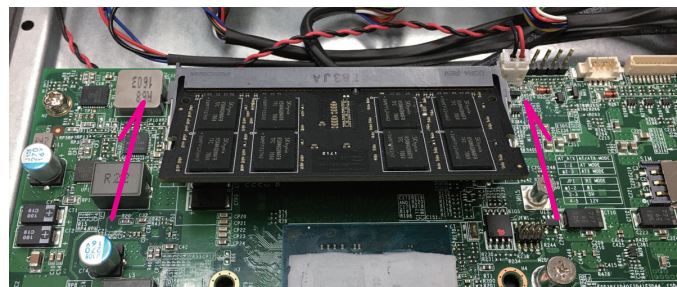

Installing a LTE/5G Module (Key B 3052)

1. Locate the M.2 Key B slot and the screw on the mainboard, then remove the screw.

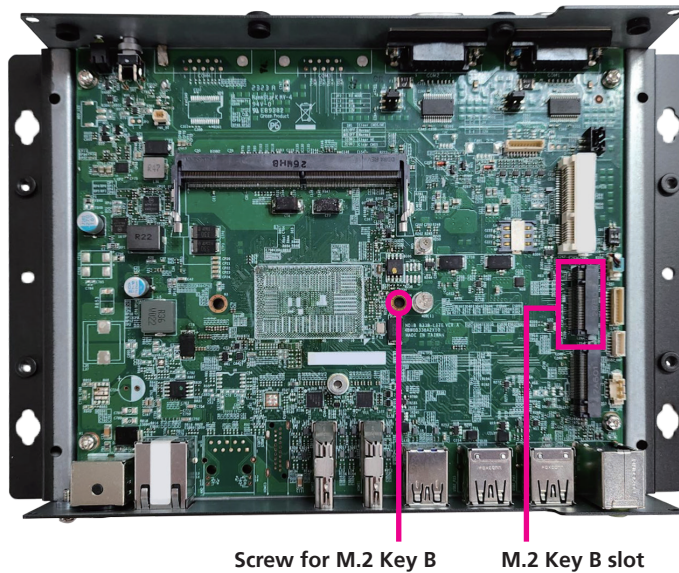

2. Insert the LTE/5G module into the M.2 Key B slot at a 45-degree angle until the gold-plated connector on the edge of the module completely disappears into the slot.



3. Push the M.2 module down and secure it with the screw that was removed from step 1.



Installing an M.2 Storage Module (Key M 2280)

1. Locate the M.2 Key M slot and the screw on the mainboard, then remove the screw.

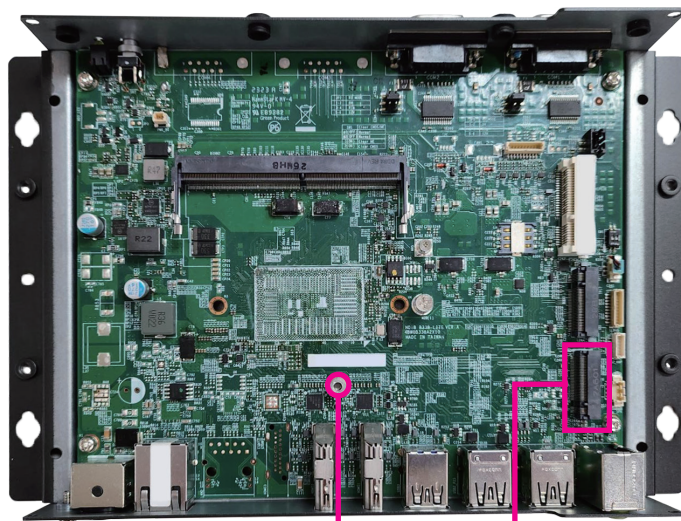

Screw for M.2 Key M

M.2 Key M slot

2. Insert the M.2 module into the M.2 Key M slot at a 45-degree angle until the gold-plated connector on the edge of the module completely disappears into the slot.

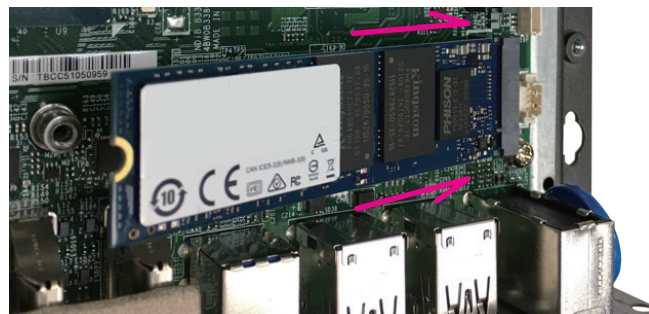

3. Push the M.2 module down and secure it with the screw that was removed from step 1.

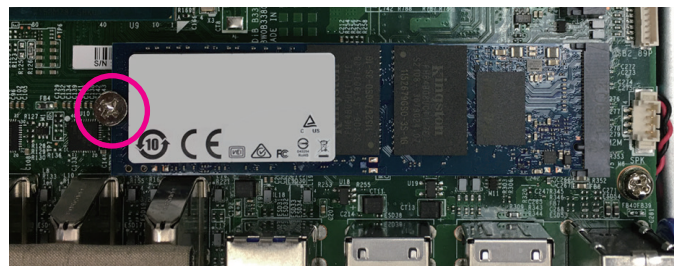

Installing a WiFi Module (Mini-PCle Slot)

1. Locate the mini-PCle slot and the screw on the mainboard, then remove the screw.

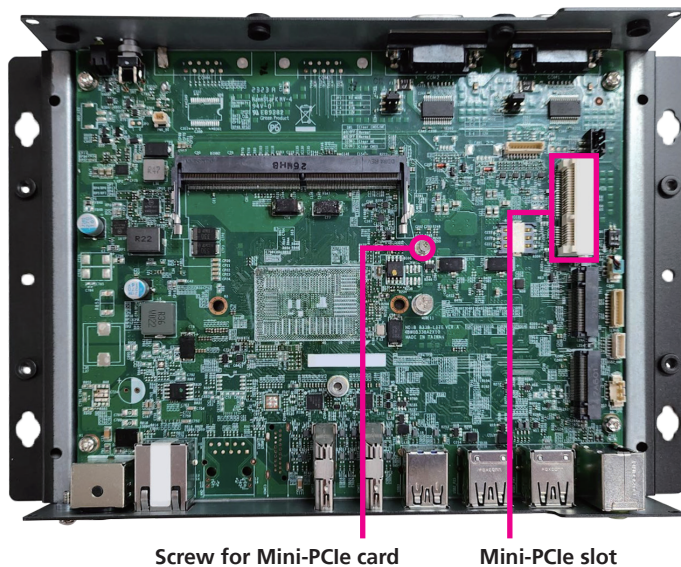

2. Insert the WiFi module into the mini PCIe slot at a 45-degree angle until the gold-plated connector on the edge of the module completely disappears into the slot.

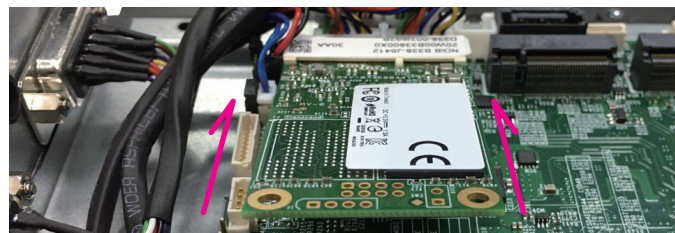

3. Push the WiFi module down and secure it with the screw that was removed from step 1.

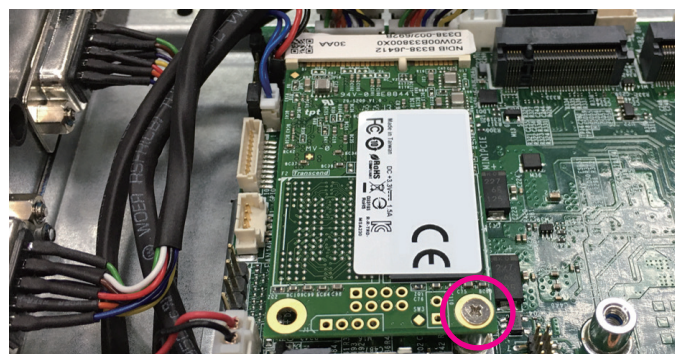

Wall mounting instructio

To mount the system on to a wall or some other surface using the two mounting brackets, please follow the steps below.

1. The wall mount bracket is integrated with the bottom cover.

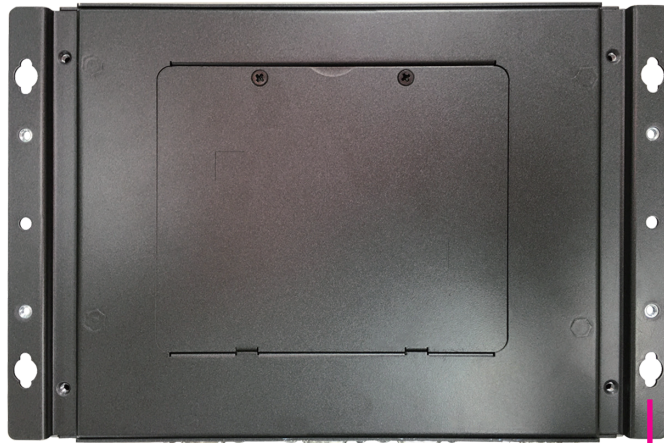

Wall mount bracket

2. Drill holes in the intended installation surface.
3. Align the mounting holes in the sides of the mounting brackets with the predrilled holes in the mounting surface.
4. Insert four retention screws, two in each bracket to secure the system to the wall.

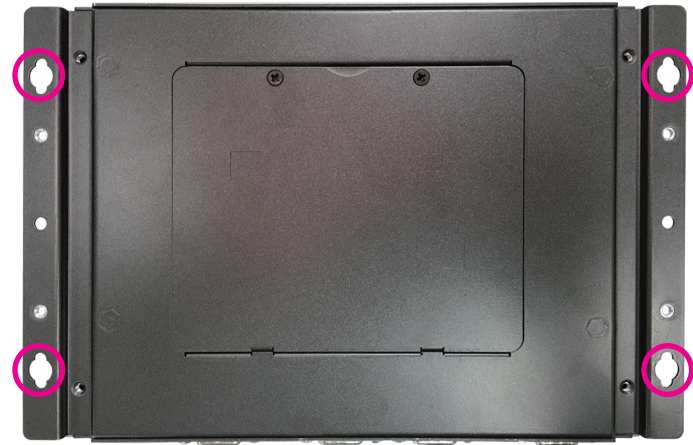

CHAPTER 4: BIOS SETUP

This chapter describes how to use the BIOS setup program for the NDiS B338-LITE. The BIOS screens provided in this chapter are for reference only and may change if the BIOS is updated in the future.

To check for the latest updates and revisions, visit the NEXCOM Web site at www.nexcom.com.tw.

About BIOS Setup

The BIOS (Basic Input and Output System) Setup program is a menu driven utility that enables you to make changes to the system configuration and tailor your system to suit your individual work needs. It is a ROM-based configuration utility that displays the system's configuration status and provides you with a tool to set system parameters.

These parameters are stored in non-volatile battery-backed-up CMOS RAM that saves this information even when the power is turned off. When the system is turned back on, the system is configured with the values found in CMOS.

With easy-to-use pull down menus, you can configure such items as:

- Hard drives, diskette drives, and peripherals
- Video display type and display options
- Password protection from unauthorized use
- Power management features

The settings made in the setup program affect how the computer performs. It is important, therefore, first to try to understand all the setup options, and second, to make settings appropriate for the way you use the computer.

When to Configure the BIOS

- This program should be executed under the following conditions:
- When changing the system configuration
- When a configuration error is detected by the system and you are prompted to make changes to the setup program
- When resetting the system clock
- When redefining the communication ports to prevent any conflicts
- When making changes to the Power Management configuration
- When changing the password or making other changes to the security setup

Normally, CMOS setup is needed when the system hardware is not consistent with the information contained in the CMOS RAM, whenever the CMOS RAM has lost power, or the system features need to be changed.

Default Configuration

Most of the configuration settings are either predefined according to the Load Optimal Defaults settings which are stored in the BIOS or are automatically detected and configured without requiring any actions. There are a few settings that you may need to change depending on your system configuration.

Entering Setup











When the system is powered on, the BIOS will enter the Power-On Self Test (POST) routines. These routines perform various diagnostic checks; if an error is encountered, the error will be reported in one of two different ways:

- If the error occurs before the display device is initialized, a series of beeps will be transmitted.
- If the error occurs after the display device is initialized, the screen will display the error message.

Powering on the computer and immediately pressing allows you to enter Setup.

Press the  key to enter Setup:

Legends

Key	Function
	Moves the highlight left or right to select a menu.
	Moves the highlight up or down between sub-menus or fields.
	Exits the BIOS Setup Utility.
	Scrolls forward through the values or options of the highlighted field.
	Scrolls backward through the values or options of the highlighted field.
	Selects a field.
	Displays General Help.
	Load previous values.
	Load optimized default values.
	Saves and exits the Setup program.
	Press <Enter> to enter the highlighted sub-menu

Scroll Bar

When a scroll bar appears to the right of the setup screen, it indicates that there are more available fields not shown on the screen. Use the up and down arrow keys to scroll through all the available fields.

Submenu

When “▶” appears on the left of a particular field, it indicates that a submenu which contains additional options are available for that field. To display the submenu, move the highlight to that field and press  .

BIOS Setup Utility

Once you enter the AMI BIOS Setup Utility, the Main Menu will appear on the screen. The main menu allows you to select from several setup functions and one exit. Use arrow keys to select among the items and press  to accept or enter the submenu.

Main

The Main menu is the first screen that you will see when you enter the BIOS Setup Utility.

```

Aptio Setup - AMI
Main Advanced Security Boot Save & Exit

-----
BIOS Information
BIOS Vendor      American Megatrends  *|
Product Name     ND1S D338 Lite      *|
Project Version  D338Lite-010T10 x64 *|
Build Date and Time 10/06/2023 17:14:33 *|
Lan1 MAC Address  00-A0-C9-00-00-00  *|
Name
Intel(R) Celeron(R) J6412 @ 2.00GHz *|
Stepping         B0                *|
Microcode Revision 15                *|
-----
IGFX GOP Version  18.0.1041          *|<: Select Screen
ME FW Version     15.40.16.2485     *|^v: Select Item
Total Memory      8192 MB           *|Enter: Select
Memory Data Rate  3200 MTPS        +|+/-: Change Opt.
PCH Information   v|F1: General Help
                 +|F2: Previous Values
                 +|F3: Optimized Defaults
                 v|F4: Save & Exit
                 |ESC: Exit

-----
Version 2.22.1282 Copyright (C) 2023 AMI

```

System Date

The date format is <day>, <month>, <date>, <year>. Day displays a day, from Monday to Sunday. Month displays the month, from January to December. Date displays the date, from 1 to 31. Year displays the year, from 1999 to 2099.

System Time

The time format is <hour>, <minute>, <second>. The time is based on the 24-hour military-time clock. For example, 1 p.m. is 13:00:00. Hour displays hours from 00 to 23. Minute displays minutes from 00 to 59. Second displays seconds from 00 to 59.

Advanced

The Advanced menu allows you to configure your system for basic operation. Some entries are defaults required by the system board, while others, if enabled, will improve the performance of your system or let you set some features according to your preference.



Setting incorrect field values may cause the system to malfunction.

```

Aptio Setup - AMI
Main  Advanced  Security  Boot  Save & Exit

-----
| ATX mode                                     | Network Stack Settings
| State After G3          [S0 State]          |
| WAKE on LAN/COM        [Enabled]           |
| USB Power State in S5  [OFF]              |
|-----|-----|
|> CPU Configuration
|> SATA Configuration
|> Trusted Computing
|> ACPI Settings
|> NCT6126D Super IO Configuration
|> Hardware Monitor
|> S5 RTC Wake Settings
|> Serial Port Console Redirection
|> USB Configuration
|> Network Stack Configuration
|> NVMe Configuration
|-----|-----|
|><: Select Screen
|^v: Select Item
|Enter: Select
|+/-: Change Opt.
|F1: General Help
|F2: Previous Values
|F3: Optimized Defaults
|F4: Save & Exit
|ESC: Exit
-----
Version 2.22.1282 Copyright (C) 2023 AMI

```

State After G3

Configure the power state when power is re-applied after a power failure (G3 state).

Wake on LAN Enable

Enable or disable the integrated LAN to wake the system.

USB Power State in S5

Configure the USB power state in S5.

CPU Configuration

This section is used to configure the CPU.

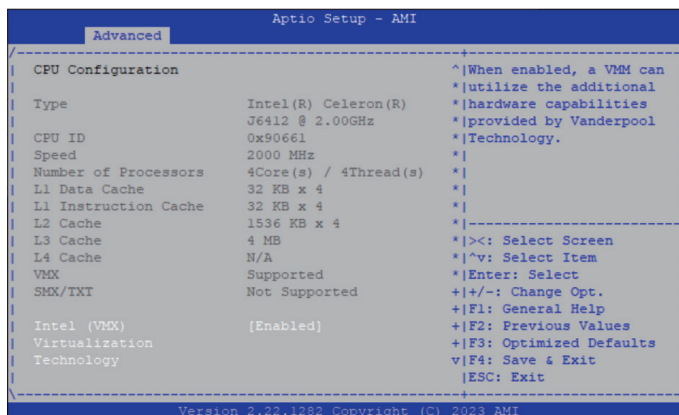

Intel® (VMX) Virtualization Technology

When this field is set to Enabled, the VMM can utilize the additional hardware capabilities provided by Vanderpool Technology.

Boot Performance Mode

Configure the performance state that the BIOS will set before OS handoff.

C states

Enable or disable CPU to go to C states when it is not 100% utilized.

Intel® SpeedStep™

Enable or disable Intel SpeedStep.

Intel® Speed Shift Technology

Enable or disable Intel Speed Shift Technology support. Enabling it will expose the CPPC v2 interface to allow hardware controlled P-states..

Turbo Mode

Enable or disable processor turbo mode (requires EMTTM enabled too). Auto means enabled.

SATA Configuration

This section displays information of the SATA drives.

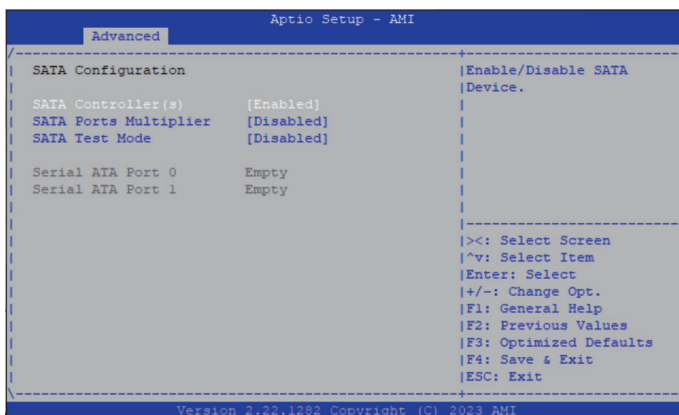

SATA Controller(s)

Enable or disable SATA device.

SATA Ports Multiplier

Enable or disable ports multiplier.

SATA Test Mode

Enable or disable test mode.

Trusted Computing

This section is used to configure Trusted Platform Module (TPM) settings.

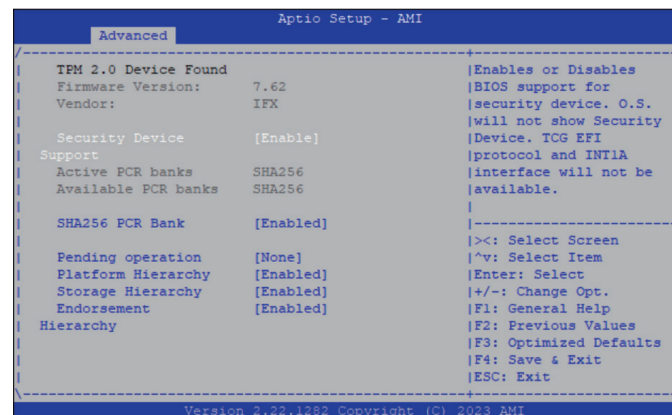

Security Device Support

Enable or disable BIOS support for security device. O.S will not show Security Device. TCG EFI protocol and INT1A interface will not be available.

SHA256 PCR Bank

Enable or disable SHA256 PCR Bank.

Pending operation

Schedule an operation for the security device.



Your computer will reboot during restart in order to change state of security device.

Platform Hierarchy

Enable or disable Platform Hierarchy.

Storage Hierarchy

Enable or disable Storage Hierarchy.

Endorsement Hierarchy

Enable or disable Endorsement Hierarchy.

ACPI Settings

This section is used to configure ACPI Settings.

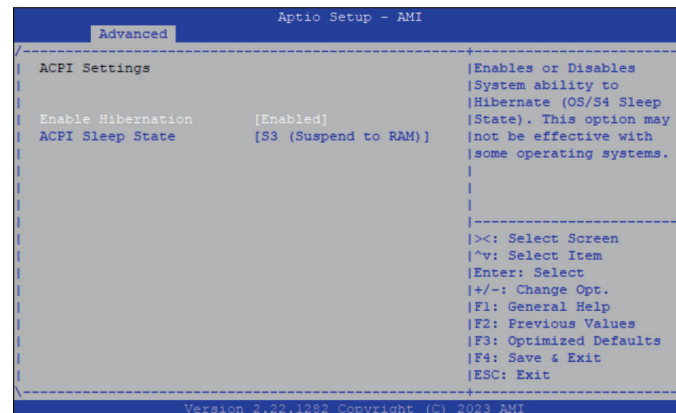

Enable Hibernation

Enable or disable system ability to hibernate (OS/S4 Sleep State). This option may not be effective with some operating systems.

ACPI Sleep State

Select the highest ACPI sleep state the system will enter when the suspend button is pressed. The options are Suspend Disabled and S3 (Suspend to RAM).

NCT6126D Super IO Configuration

This section is used to configure the I/O functions supported by the onboard Super I/O chip.

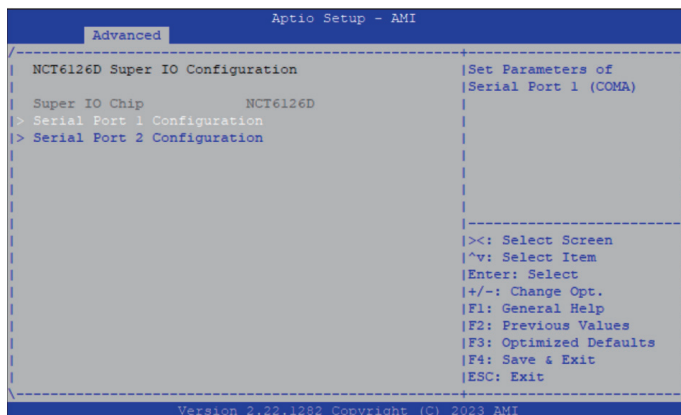

Super IO Chip

Display the Super I/O chip used on the board.

Serial Port 1/2 Configuration

Enter the submenu of Serial port 1/2 configuration.

Serial Port 1/2 Configuration

This section is used to configure the serial ports.

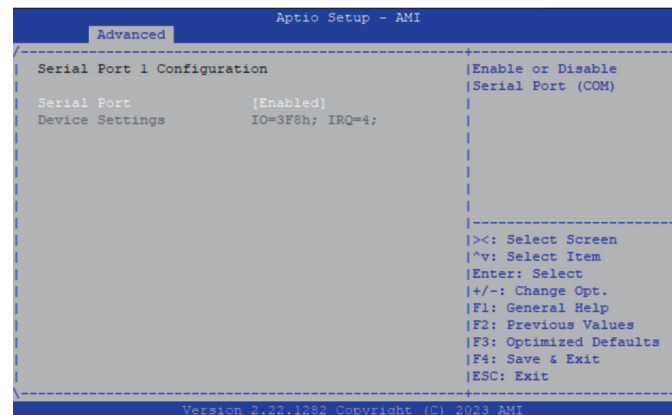

Serial Port

Enable or disables the serial port.

PC Health Status

This section is used to monitor hardware status such as temperature, fan speed and voltages.

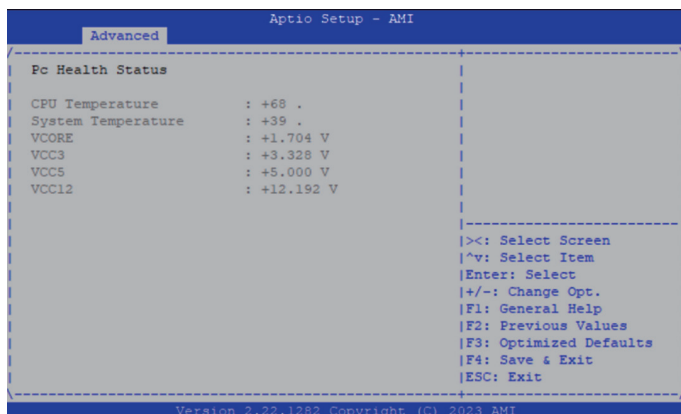

VCC5

Detect and display 5V voltage.

VCC12

Detect and display 12V voltage.

CPU Temperature(DTS)

Detect and display the current CPU temperature.

System Temperature

Detect and display the current system temperature.

VCore

Detect and display the Vcore CPU voltage.

VCC3

Detect and display 3.3V voltage.

S5 RTC Wake Settings

This section is used to configure S5 RTC Wake Settings.

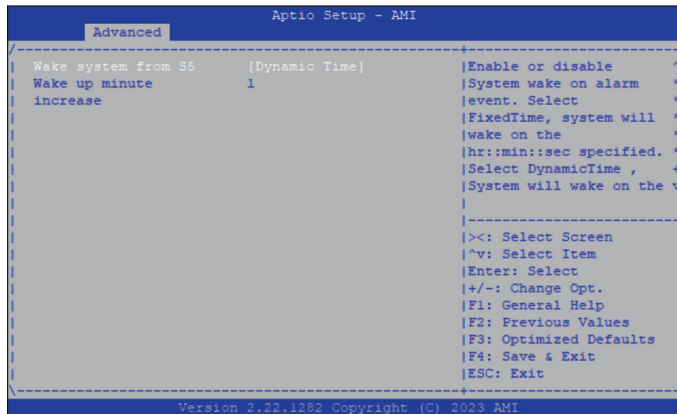

Wake system from S5

- Disabled Disables the system wake from S5.
- Fixed Time Sets the system wake-up time in hours, minutes, or seconds.
- Dynamic Time System will wake on the current time + increase minute(s)

Wake System from S5

This section is used to configure S5 RTC wake settings.



Wake system from S5

Enable or disable system wake up from S5.

Fixed Time: System will wake on the hr : min : sec specified.

Dynamic Time: System will wake on the current time + increase minute(s)



USB does not support S3, S4 and S5 wake.

USB Configuration

This section is used to configure the USB.

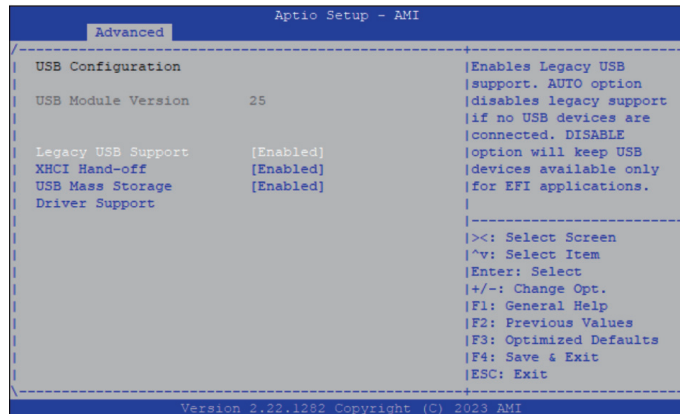

Legacy USB Support

Enable Enable Legacy USB.

Auto Disable support for Legacy when no USB devices are connected.

Disable Keep USB devices available only for EFI applications.

XHCI Hand-off

This is a workaround for OSs that does not support XHCI hand-off. The XHCI ownership change should be claimed by the XHCI driver.

USB Mass Storage Driver Support

Enable or disable USB mass storage driver support.

Network Stack Configuration

This section is used to configure the network stack.

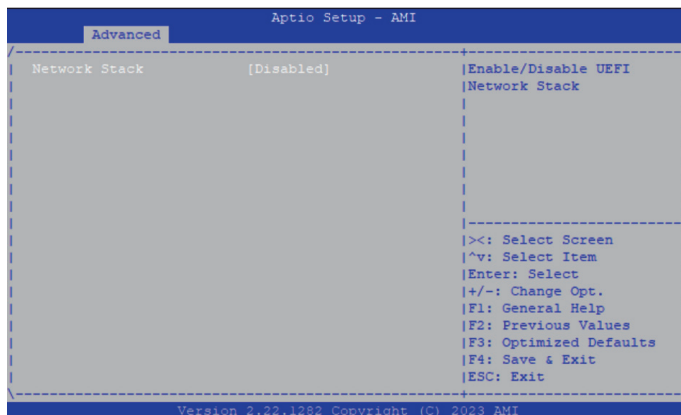

Network Stack

Enable or disable UEFI network stack. Once enabled, more options will be available for configuration.

Network Stack

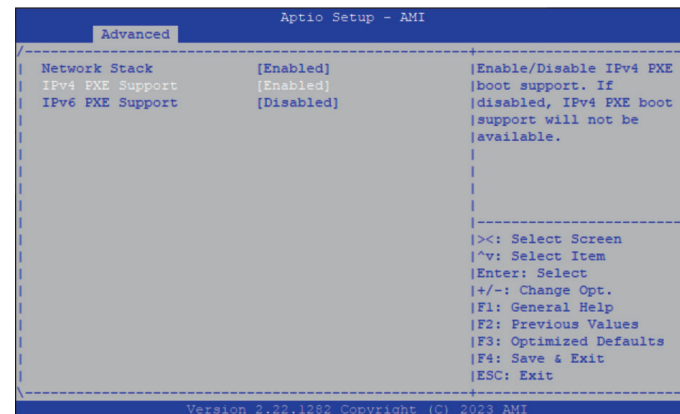

Network Stack

Enable or disable UEFI network stack.

IPv4 PXE Support

Enable or disable IPv4 PXE boot support. If disabled, IPv4 PXE boot option will not be created.

IPv4 HTTP Support

Enable or disable IPv4 HTTP support.

NVMe Configuration

This section is used to display information on the NVMe devices installed.

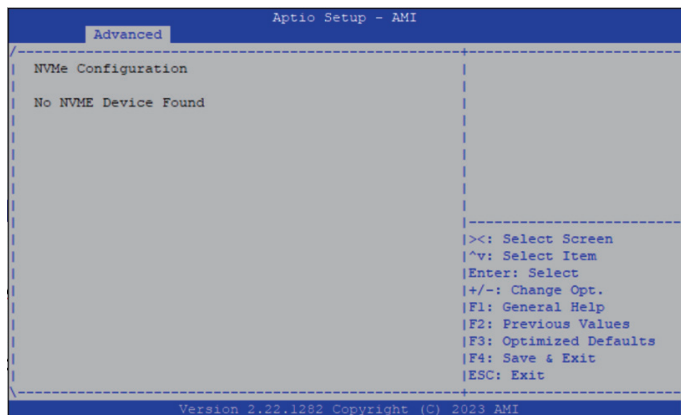

Security

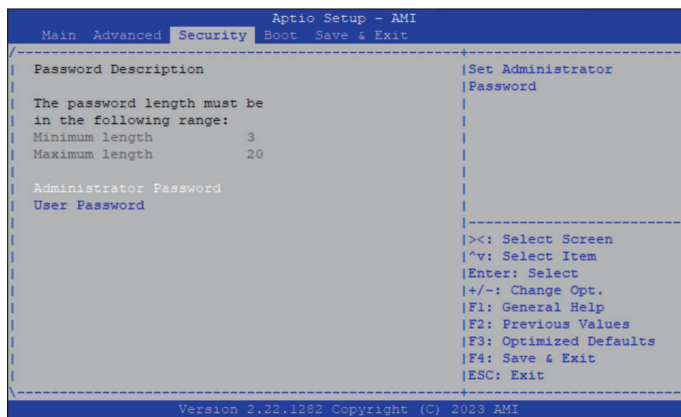

Administrator Password

Select this to reconfigure the administrator's password.

User Password

Select this to reconfigure the user's password.

Boot

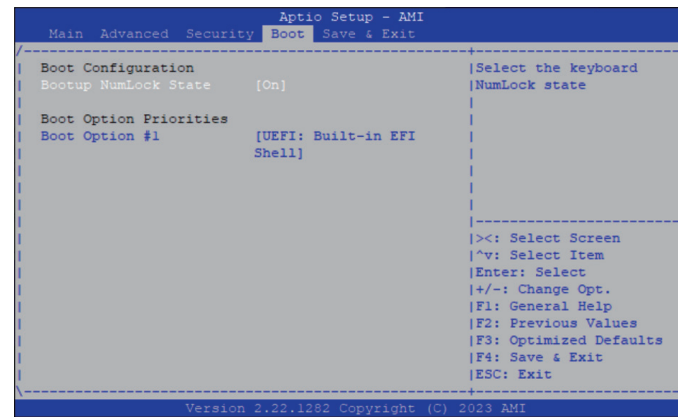

Bootup NumLock State

This allows you to determine the default state of the numeric keypad. By default, the system boots up with NumLock on wherein the function of the numeric keypad is the number keys. When set to Off, the function of the numeric keypad is the arrow keys.

Boot Option Priorities

Adjust the boot sequence of the system. Boot Option #1 is the first boot device that the system will boot from, next will be #2 and so forth.

Save & Exit

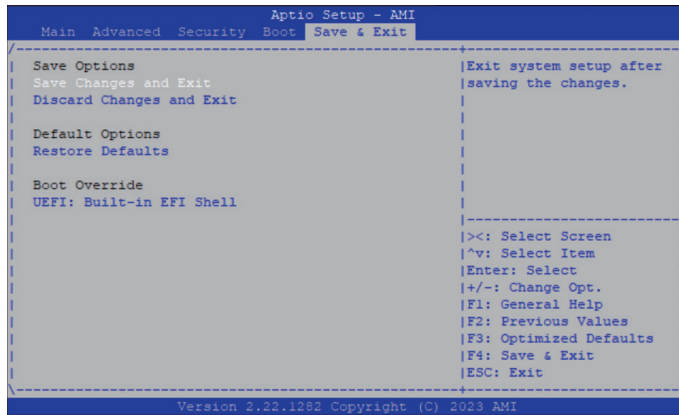

Save Changes and Exit

To save the changes and exit, select this field then press <Enter>. A dialog box will appear. Confirm by selecting Yes.

Discard Changes and Exit

To exit the Setup utility and reset without saving the changes, select this field then press <Enter>. You may be prompted to confirm again before exiting.

Restore Defaults

To restore the BIOS to default settings, select this field then press <Enter>. A dialog box will appear. Confirm by selecting Yes.

Boot Override

To bypass the boot sequence from the Boot Option List and boot from a particular device, select the desired device and press <Enter>.