

# PT-G7828/G7728 User's Manual

---

Edition 1.4, October 2019

[www.moxa.com/product](http://www.moxa.com/product)



© 2019 Moxa Inc. All rights reserved.

# PT-G7828/G7728 User's Manual

The software described in this manual is furnished under a license agreement and may be used only in accordance with the terms of that agreement.

## Copyright Notice

© 2019 Moxa Inc. All rights reserved.

## Trademarks

The MOXA logo is a registered trademark of Moxa Inc.  
All other trademarks or registered marks in this manual belong to their respective manufacturers.

## Disclaimer

Information in this document is subject to change without notice and does not represent a commitment on the part of Moxa.

Moxa provides this document as is, without warranty of any kind, either expressed or implied, including, but not limited to, its particular purpose. Moxa reserves the right to make improvements and/or changes to this manual, or to the products and/or the programs described in this manual, at any time.

Information provided in this manual is intended to be accurate and reliable. However, Moxa assumes no responsibility for its use, or for any infringements on the rights of third parties that may result from its use.

This product might include unintentional technical or typographical errors. Changes are periodically made to the information herein to correct such errors, and these changes are incorporated into new editions of the publication.

## Technical Support Contact Information

[www.moxa.com/support](http://www.moxa.com/support)

### **Moxa Americas**

Toll-free: 1-888-669-2872  
Tel: +1-714-528-6777  
Fax: +1-714-528-6778

### **Moxa Europe**

Tel: +49-89-3 70 03 99-0  
Fax: +49-89-3 70 03 99-99

### **Moxa India**

Tel: +91-80-4172-9088  
Fax: +91-80-4132-1045

### **Moxa China (Shanghai office)**

Toll-free: 800-820-5036  
Tel: +86-21-5258-9955  
Fax: +86-21-5258-5505

### **Moxa Asia-Pacific**

Tel: +886-2-8919-1230  
Fax: +886-2-8919-1231

# Table of Contents

<b>1. About this Manual</b>	<b>1-1</b>
<b>2. Getting Started</b>	<b>2-1</b>
USB Console Configuration (115200, None, 8, 1, VT100)	2-2
Configuration by Command Line Interface (CLI)	2-4
Configuration by Web Console	2-6
Disabling Telnet and Browser Access	2-8
<b>3. Featured Functions</b>	<b>3-1</b>
Home	3-2
System Settings	3-3
System Information	3-3
Module Information	3-4
User Account	3-4
Password Login Policy	3-7
Network	3-7
Date and Time	3-10
NTP Authentication Settings	3-12
IEEE 1588	3-13
Warning Notification	3-19
MAC Address Table	3-25
System Files	3-26
Restart	3-29
Factory Default	3-29
PoE (PoE Models Only)	3-30
PoE Settings	3-30
VLAN	3-41
The Virtual LAN (VLAN) Concept	3-41
Sample Applications of VLANs Using Moxa Switches	3-43
Configuring a Virtual LAN	3-44
VLAN Name Setting	3-46
QinQ Settings	3-46
VLAN Table	3-46
Port	3-47
Port Settings	3-47
Port Status	3-48
Link Aggregation	3-49
Link-Swap Fast Recovery	3-51
RSTP Grouping	3-51
Multicast	3-53
The Concept of Multicast Filtering	3-53
IGMP Snooping	3-56
IGMP Snooping Setting	3-56
IGMP Group Status	3-57
Stream Table	3-58
Static Multicast Address	3-59
GMRP	3-59
Multicast Filtering Behavior	3-61
QoS	3-61
The Traffic Prioritization Concept	3-61
Configuring Traffic Prioritization	3-63
CoS Classification	3-64
Priority Mapping	3-65
DSCP Mapping	3-66
Rate Limiting	3-66
Security	3-68
Management Interface	3-68
Trusted Access	3-69
SSL Certificate Management	3-71
SSH Key Management	3-71
Authentication	3-71
Port Security	3-77
Port Access Control Table	3-81
Loop Protection	3-81
Access Control List	3-81
DHCP	3-88
IP-Port Binding	3-88
DHCP Relay Agent	3-88
SNMP	3-90
SNMP Read/Write Settings	3-92

Trap Settings .....	3-93
Industrial Protocols .....	3-97
Diagnostics .....	3-98
LLDP .....	3-98
Ping .....	3-99
Port Mirroring .....	3-99
Monitoring .....	3-99
CPU/Memory Utilization .....	3-100
Statistics .....	3-100
Fiber Digital Diagnostics Monitoring (Fiber Check) .....	3-102
Event Log .....	3-104
Tracking Function .....	3-104
Substation .....	3-109
IEC 61850 QoS .....	3-109
GOOSE Check .....	3-110
MMS server .....	3-112
<b>A. MIB Groups .....</b>	<b>A-1</b>

# About this Manual

---

Thank you for purchasing a Moxa managed Ethernet switch. Read this user's manual to learn how to connect your Moxa switch to Ethernet-enabled devices used for industrial applications.

A synopsis of chapters 2 and 3 are given below:

□ **Chapter 2: Getting Started**

In this chapter, we explain the initial installation process for a Moxa switch. Moxa switches provide three interfaces to access the configuration settings: USB console interface, command line interface, and web console interface.

□ **Chapter 3: Featured Functions**

In this chapter, we explain how to access a Moxa switch's various configuration, monitoring, and management functions. The functions can be accessed by USB console, Telnet console, and web console (web browser). We describe how to configure the switch functions via web console, which provides the most user-friendly way to configure a Moxa switch.

## Getting Started

---

In this chapter, we explain how to install a Moxa switch for the first time. There are three ways to access the Moxa switch's configuration settings: USB console, command line interface, or web-based interface. If you do not know the Moxa switch's IP address, you can open the USB console by connecting the Moxa switch to a PC's USB port with a USB cable. You can open the Telnet or web-based console over an Ethernet LAN or over the Internet.

The following topics are covered in this chapter:

- ❑ **USB Console Configuration (115200, None, 8, 1, VT100)**
- ❑ **Configuration by Command Line Interface (CLI)**
- ❑ **Configuration by Web Console**
- ❑ **Disabling Telnet and Browser Access**

# USB Console Configuration (115200, None, 8, 1, VT100)

**NOTE** A Moxa switch allows multi-session connections (up to 6) by connecting to the web console and another console (serial or Telnet) at the same time.

**NOTE** We recommend **using PComm Terminal Emulator** when opening the USB console. This software can be downloaded free of charge from the Moxa website.

Before running PComm Terminal Emulator, first install the USB console driver on your PC and then connect the Moxa switch's USB console port to your PC's USB port with a USB cable.

After installing PComm Terminal Emulator, open the Moxa switch's USB console as follows:

1. From the Windows desktop, click **Start → Moxa → PComm Lite Ver1.6 → Terminal Emulator**.

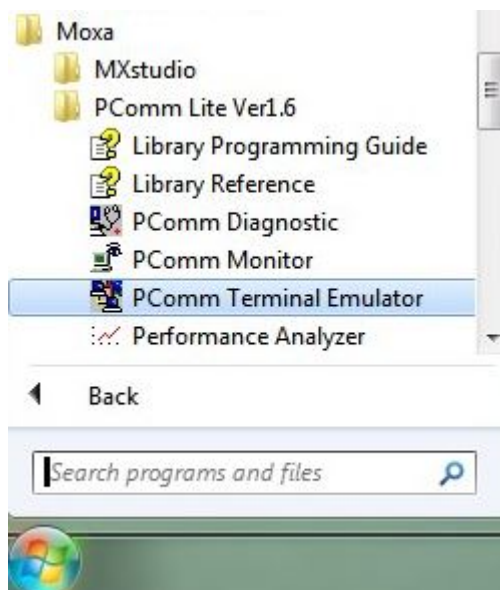

2. Select **Open** under the **Port Manager** menu to open a new connection.

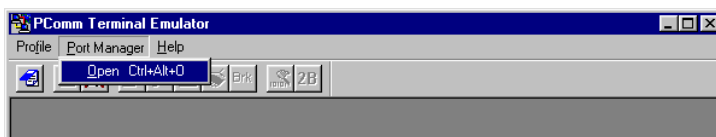

3. The **Property** window should open. On the **Communication Parameter** tab for **Ports**, select the COM port that is being used for the console connection. Set the other fields as follows: **115200** for **Baud Rate**, **8** for **Data Bits**, **None** for **Parity**, and **1** for **Stop Bits**.

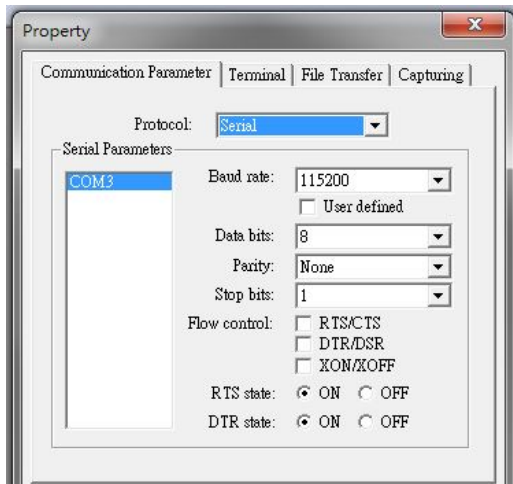

4. On the **Terminal** tab, select **VT100** for **Terminal Type**, and then click **OK** to continue.

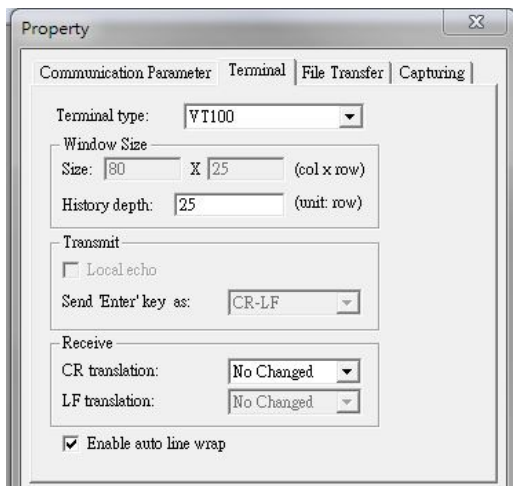

5. In the terminal window, the Moxa switch will prompt you to select a terminal type. Enter **1** to select **ansi/vt100** and then press **Enter**.

```
Moxa EtherDevice Switch PT-G7828
Console terminal type (1: ansi/vt100, 2: vt52) : 1
```

6. The USB console will prompt you to log in. Press **Enter** and select **admin** or **user**. Use the down arrow key on your keyboard to select the **Password** field and enter a password if desired. This password will be required to access any of the consoles (web, serial, Telnet).

```
Model : PT-G7828
Name :
Location : Switch Location

Firmware Version : V0.9 build 17080316
Serial No : MOXA00000000
IP : 192.168.127.253
MAC Address : 00-90-E8-55-66-99

+-----+
| Account : |
| Password : |
+-----+
```

**NOTE** By default, the password assigned to the Moxa switch is **moxa**. Be sure to change the default password after you first log in to help keep your system secure.



7. The **Main Menu** of the Moxa switch’s USB console should appear. (In PComm Terminal Emulator, you can adjust the font by selecting **Font...** from the **Edit** menu.)

```

PT-G7828 V0.9 build 17080316
-----
1.Basic Settings      - Basic settings for network and system parameter.
2.Port Trunking       - Allows multiple ports to be aggregated as a link.
3.SNMP                - SNMP settings.
4.Redundancy Protocol - Establish Ethernet communication redundant path.
5.QoS                 - Prioritize Ethernet traffic to help determinism.
6.VLAN                - Set up a VLAN by IEEE802.1Q VLAN.
7.Multicast           - Enable the multicast filtering capability.
8.Rate Limiting       - Restrict unpredictable network traffic.
9.Security            - Port access control by IEEE802.1X or Static Port Lock.
a.Warning Notification - Warning email and/or relay output by events.
b.Link-Swap Recovery  - Fast recovery after moving devices to different ports.
c.DHCP                - Assign IP addresses to connected devices.
d.Diagnostics         - Ping command and the settings for Mirror port, LLDP.
e.Monitoring          - Monitor a port and network status.
f.MAC Address Table   - Complete Ethernet MAC Address table.
g.Layer 3 Settings    - Layer 3 settings for interfaces and routing protocols.
h.System log          - Syslog and Event log settings.
i.Exit                - Exit
                    - Use the up/down arrow keys to select a category,
                    and then press Enter to select. -
    
```

8. Use the following keys on your keyboard to navigate the Moxa switch’s USB console:

Key	Function
Up, down, right, left arrow keys, Tab	Move the onscreen cursor
Enter	Display and select options
Space	Toggle options
Esc	Previous menu

## Configuration by Command Line Interface (CLI)

Opening the Moxa switch’s Telnet or web console over a network requires that the PC host and Moxa switch are on the same logical subnet. You may need to adjust your PC host’s IP address and subnet mask. By default, the Moxa switch’s IP address is 192.168.127.253 and the Moxa switch’s subnet mask is 255.255.255.0 (referred to as a Class B network). Your PC’s IP address must be set to 192.168.xxx.xxx if the subnet mask is 255.255.0.0, or to 192.168.127.xxx if the subnet mask is 255.255.255.0.

**NOTE** To connect to the Moxa switch’s Telnet or web console, your PC host and the Moxa switch must be on the same logical subnet.

**NOTE** When connecting to the Moxa switch’s Telnet or web console, first connect one of the Moxa switch’s Ethernet ports to your Ethernet LAN, or directly to your PC’s Ethernet port. You may use either a straight-through or cross-over Ethernet cable.

**NOTE** The Moxa switch’s default IP address is 192.168.127.253.

After making sure that the Moxa switch is connected to the same LAN and logical subnet as your PC, open the Moxa switch's Telnet console as follows:

1. Click **Start → Run** from the Windows Start menu and then Telnet to the Moxa switch's IP address from the Windows **Run** window. You may also issue the Telnet command from a DOS prompt.

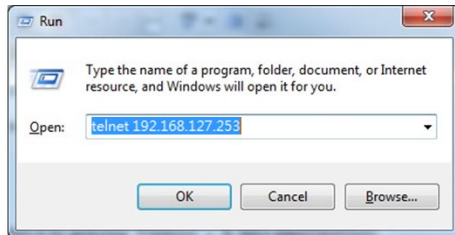

2. In the terminal window, the Telnet console will prompt you to select a terminal type. Type **1** to choose **ansi/vt100**, and then press **Enter**.

```
MOXA EtherDevice Switch PT-G7828
Console terminal type (1: ansi/vt100, 2: vt52) : 1
```

3. The Telnet console will prompt you to log in. Press **Enter** and then select **admin** or **user**. Use the down arrow key on your keyboard to select the **Password** field and enter a password if desired. This password will be required to access any of the consoles (web, serial, Telnet). If you do not wish to create a password, leave the **Password** field blank and press **Enter**.

```
Model : PT-G7828
Name :
Location : Switch Location

Firmware Version : V0.9 build 17080316
Serial No : MOXA00000000
IP : 192.168.127.253
MAC Address : 00-90-E8-55-66-99

+-----+
| Account : |
| Password : |
+-----+
```

4. The **Main Menu** of the Moxa switch's Telnet console should appear.

```
PT-G7828 V0.9 build 17080316
-----
1.Basic Settings - Basic settings for network and system parameter.
2.Port Trunking - Allows multiple ports to be aggregated as a link.
3.SNMP - SNMP settings.
4.Redundancy Protocol - Establish Ethernet communication redundant path.
5.QoS - Prioritize Ethernet traffic to help determinism.
6.VLAN - Set up a VLAN by IEEE802.1Q VLAN.
7.Multicast - Enable the multicast filtering capability.
8.Rate Limiting - Restrict unpredictable network traffic.
9.Security - Port access control by IEEE802.1X or Static Port Lock.
a.Warning Notification - Warning email and/or relay output by events.
b.Link-Swap Recovery - Fast recovery after moving devices to different ports.
c.DHCP - Assign IP addresses to connected devices.
d.Diagnostics - Ping command and the settings for Mirror port, LLDP.
e.Monitoring - Monitor a port and network status.
f.MAC Address Table - Complete Ethernet MAC Address table.
g.Layer 3 Settings - Layer 3 settings for interfaces and routing protocols.
h.System log - Syslog and Event log settings.
i.Exit - Exit
- Use the up/down arrow keys to select a category,
and then press Enter to select. -
```

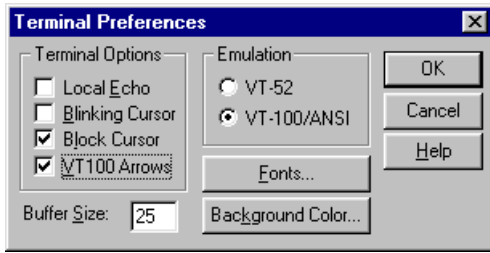

- Use the following keys on your keyboard to navigate the Moxa switch's Telnet console:

Key	Function
Up, down, right, left arrow keys, Tab	Move the onscreen cursor
Enter	Display and select options
Space	Toggle options
Esc	Previous menu

**NOTE** The Telnet console looks and operates in precisely the same manner as the USB console.

## Configuration by Web Console

The Moxa switch's web console is a convenient platform for modifying the configuration and accessing the built-in monitoring and network management functions. You can open the Moxa switch's web console using a standard web browser, such as Internet Explorer.

**NOTE** When connecting to the Moxa switch's Telnet or web console, your PC host and the Moxa switch must be on the same logical subnet.

**NOTE** If the Moxa switch is configured for other VLAN settings, you must make sure your PC host is on the management VLAN.

**NOTE** When connecting to the Moxa switch's Telnet or web console, first connect one of the Moxa switch's Ethernet ports to your Ethernet LAN, or directly to your PC's Ethernet port. You may use either a straight-through or cross-over Ethernet cable.

**NOTE** The Moxa switch's default IP address is 192.168.127.253.

After making sure that the Moxa switch is connected to the same LAN and logical subnet as your PC, open the Moxa switch's web console as follows:

1. Connect your web browser to the Moxa switch's IP address by entering it in the **Address** or **URL** field.
2. The Moxa switch's web console will open, and you will be prompted to log in. Select the login account (admin or user) and enter the **Password**. This password will be required to access any of the consoles (web, serial, Telnet). If you do not wish to create a password, leave the **Password** field blank and press **Enter**.



**NOTE** By default, the password assigned to the Moxa switch is **moxa**. Be sure to change the default password after you first log in to help keep your system secure.

3. After logging in, you may need to wait a few moments for the web console to appear. Use the folders in the left navigation panel to navigate between different pages of configuration options.

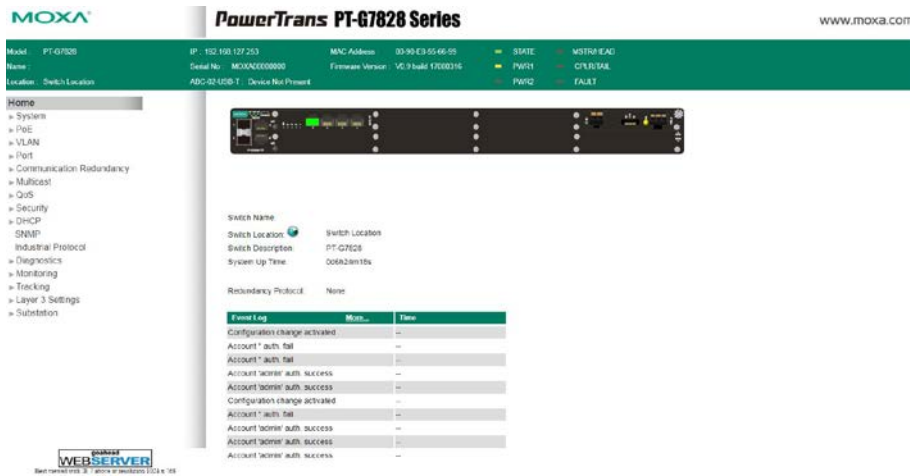

## Disabling Telnet and Browser Access

If you are connecting the Moxa switch to a public network but do not intend to manage it over the network, we suggest disabling both the Telnet and web consoles. This is done from the USB console by navigating to **System Identification** under **Basic Settings** → **System Information**. Disable or enable the **Telnet Console** and **Web Configuration** as shown below:

```

MOXA EtherDevice Switch PT-G7828
Basic Settings
[System Information] [User Account] [Trusted Access] [Port] [Network]
[Date and Time] [GARP Timer] [Restart] [Factory default] [Firmware Upgrade]
[Config File] [Login mode] [Activate] [Main menu]
System Identification
ESC: Previous menu  Enter: Select  Space bar: Toggle

Switch Name           [
Switch Location       [Switch Location
Switch Description    [PT-G7828
Contact Information   [

Serial NO.            MOXA00000000
Firmware Version      V0.9 build 17080316
MAC Address           00-90-E8-55-66-99

Telnet Console        [Enable ]
Web Configuration     [http or https]
Web Auto-logout (s)  [5
Aging Time (s)       [300

```

## Featured Functions

---

In this chapter, we explain how to access the Moxa switch's various configuration, monitoring, and management functions. These functions can be accessed by USB console, Telnet console, or web console. The USB console can be used if you do not know the Moxa switch's IP address. To access the USB console, connect switch's USB port to your PC's COM port. The Telnet and web consoles can be opened over an Ethernet LAN or the Internet.

The web console is the most user-friendly interface for configuring a Moxa switch. In this chapter, we use the web console interface to introduce the console functions. There are only a few differences between the web console, USB console, and Telnet console.

The following topics are covered in this chapter:

- ❑ **Home**
- ❑ **System Settings**
- ❑ **PoE (PoE Models Only)**
- ❑ **VLAN**
- ❑ **Port**
- ❑ **RSTP Grouping**
- ❑ **Multicast**
- ❑ **QoS**
- ❑ **Security**
- ❑ **DHCP**
- ❑ **SNMP**
- ❑ **Industrial Protocols**
- ❑ **Diagnostics**
- ❑ **Monitoring**
- ❑ **Substation**

# Home

The **Home** page shows the summary of the Moxa switch information including System Information, Redundancy Protocol, Event Log, and Device virtualization panel. By showing the switch's information and event log, the operators can easily understand the system and port link status at a glance.

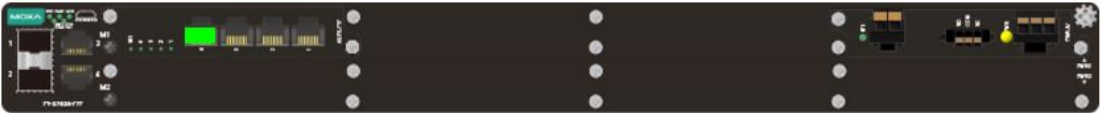

Switch Name: Switch Location

Switch Location:  Switch Location

Switch Description: PT-G7828

System Up Time: 0d6h48m34s

Redundancy Protocol: None

Event Log	More...	Time
Account " auth. fail		--
Account 'admin' auth. fail		--
Account 'admin' auth. success		--
Account " auth. fail		--
Account 'admin' auth. success		--
Account " auth. fail		--
Account " auth. fail		--
Account 'admin' auth. success		--
Account 'admin' auth. success		--
Account 'admin' auth. success		--

# System Settings

The **System Settings** section includes the most common settings required by administrators to maintain and control a Moxa switch.

## System Information

Define **System Information** items to make it easier to identify different switches that are connected to your network.

**System Information**

Switch Name:

Switch Location:

15 characters / Maximum 255 characters

Switch Description:

Contact Information:

Web Login Message:

0 characters / Maximum 240 characters

Login Authentication Failure Message:

0 characters / Maximum 240 characters

[Apply](#)

### Switch Name

Setting	Description	Factory Default
Max. 30 characters	This option is useful for differentiating between the roles or applications of different units. Example: ManagedRedundantSwitch00000	none

**NOTE** The Switch Name field does not allow spaces.

### Switch Location

Setting	Description	Factory Default
Max. 255 characters	This option is useful for differentiating between the locations of different switches. Example: production line 1.	Switch Location

### Switch Description

Setting	Description	Factory Default
Max. 30 characters	This option is useful for recording a more detailed description of the unit.	Switch Model name



**Contact Information**

Setting	Description	Factory Default
Max. 30 characters	This option is useful for providing information about who is responsible for maintaining this unit and how to contact this person.	None

**Web Login Message**

Setting	Description	Factory Default
Max. 240 characters	This option is useful as it shows a message when a user's login is successful	Switch Location

**Login Authentication Failure Message**

Setting	Description	Factory Default
Max. 240 characters	This option is useful as it shows a message when a user's login has failed	Switch Location

## Module Information

This page displays the model name and serial number information of the device, including main chassis, line module, and power module. Below is an example of the information that will be displayed.

**Module Information**

**Main Chassis:**

Model Name	Serial Number
PT-G7828	MOXA00000000

**Line Module:**

Slot	Model Name	Serial Number
1	LM-7000H-4GTX	MOXA00000000
2	--	--
3	--	--
4	--	--
5	--	--
6	--	--

**Power Unit:**

Slot	Model Name	Serial Number
1	PWR-LV-P48	MOXA00000000
2	--	--

## User Account

The Moxa switch supports the management of accounts, including establishing, activating, modifying, disabling, and removing accounts. There are two levels of configuration access: admin and user. Accounts with **admin** authority have read/write access of all configuration parameters, whereas accounts with **user** authority only have read access to view configuration items.

- NOTE**
1. In order to maintain a higher level of security, we strongly suggest that you change the password after you first log in.
  2. By default, the **admin** user account cannot be deleted or disabled.

### User Account

Active

Authority admin

User Name

Password

Confirm Password

Create
Apply

#### Account List

Active	User Name	Authority	
<input checked="" type="checkbox"/>	admin	admin	
<input checked="" type="checkbox"/>	user	user	<span style="border: 1px solid black; padding: 2px;">Delete</span>

**Active**

Setting	Description	Factory Default
Checked	This account can access the switch's configuration settings.	Checked
Unchecked	This account cannot access the switch's configuration settings.	

**Authority**

Setting	Description	Factory Default
admin	This account has read/write access of all configuration parameters.	admin
user	This account can only view configuration parameters.	

## Creating a New Account

Click **Create**, type in the user name and password, and assign an authority to the new account. Click **Apply** to add the account to the **Account List** table.

Setting	Description	Factory Default
User Name (Max. of 30 characters)	User Name	None
Password	Password for the user account. (between 4 and 16 characters)	None

## Modifying an Existing Account

Select an existing account from the Account List table, modify the account details, and then click **Apply** to save the changes.

**User Account**

Active

Authority

User Name

Old Password

Password

Confirm Password

**Account List**

Active	User Name	Authority	
<input checked="" type="checkbox"/>	admin	admin	<input type="button" value="Delete"/>
<input checked="" type="checkbox"/>	user	user	<input type="button" value="Delete"/>

## Deleting an Existing Account

Select an account from the **Account List** table and then click **Delete** to delete the account.

**User Account**

Active

Authority

User Name

Old Password

Password

Confirm Password

**Account List**

Active	User Name	Authority	
<input checked="" type="checkbox"/>	admin	admin	
<input checked="" type="checkbox"/>	user	user	<input type="button" value="Delete"/>
<input checked="" type="checkbox"/>	testuser1	admin	<input type="button" value="Delete"/>

## Password Login Policy

In order to prevent hackers from cracking the password, Moxa switches allow users to configure a password for their account and lock the account in the event that the wrong password is entered. The account password policy requires passwords to be of a minimum length and complexity with a strength check. If Account Login Failure Lockout is enabled, you will need to configure the **Retry Failure Threshold** and **Lockout Time** parameters. If the number of login attempts exceeds the Retry Failure Threshold, users will need to wait the number of minutes configured in Lockout Time before trying again.

### Account Password and Login Management

#### Account Password Policy

Minimum Length  (4~16)

Enable password complexity strength check

- At least one digit (0~9)
- Mixed upper and lower case letters (A~Z, a~z)
- At least one special character (~!@#\$%^&\*~\_!;:.,<>[]{}())

#### Account Login Failure Lockout

Enable

Retry Failure Threshold  (1~10)

Lockout Time (min)  (1~60)

## Network

Network configuration allows users to configure both IPv4 and IPv6 parameters for management access over the network. The Moxa switch supports both IPv4 and IPv6, and can be managed through either of these address types.

## IP Settings

The IPv4 settings include the switch’s IP address and subnet mask, as well as the IP address of the default gateway. In addition, input cells are provided for the IP addresses of a 1st and 2nd DNS server.

The IPv6 settings include two distinct address types—Link-Local Unicast addresses and Global Unicast addresses. A Link-Local address makes the switch accessible over IPv6 for all devices attached to the same local subnet. To connect to a larger network with multiple segments, the switch must be configured with a Global Unicast address.

**IP Settings**

Get IP From: DHCP ▾

IP Address: 172.21.0.145

Subnet Mask: 25(255.255.255.128) ▾

Default Gateway: 172.21.0.254

1st DNS Server: 192.168.50.41

2nd DNS Server: 192.168.50.33

IPv6 Global Unicast Address Prefix:

IPv6 Global Unicast Address: ::

IPv6 Link-Local Address: fe80::290:e8ff:fe02:406

Apply

### Get IP From

Setting	Description	Factory Default
DHCP	The Moxa switch’s IP address will be assigned automatically by the network’s DHCP server.	Manual
BOOTP	The Moxa switch’s IP address will be assigned automatically by the network’s BootP server.	
Manual	The Moxa switch’s IP address must be set manually.	

### IP Address

Setting	Description	Factory Default
IP address for the Moxa switch	Assigns the Moxa switch’s IP address on a TCP/IP network.	192.168.127.253

### Subnet Mask

Setting	Description	Factory Default
Subnet mask for the Moxa switch	Identifies the type of network the Moxa switch is connected to (e.g., 255.255.0.0 for a Class B network, or 255.255.255.0 for a Class C network).	24(255.255.255.0)

### Default Gateway

Setting	Description	Factory Default
IP address for gateway	Specifies the IP address of the router that connects the LAN to an outside network.	None

**DNS Server IP Addresses**

Setting	Description	Factory Default
1st DNS Server	Specifies the IP address of the DNS server used by your network. After specifying the DNS server's IP address, you can use the Moxa switch's URL (e.g., www.PT.company.com) to open the web console instead of entering the IP address.	None
2nd DNS Server	Specifies the IP address of the secondary DNS server used by your network. The Moxa switch will use the secondary DNS server if the first DNS server fails to connect.	None

**IPv6 Global Unicast Address Prefix (Prefix Length: 64 bits) Default Gateway**

Setting	Description	Factory Default
Global Unicast Address Prefix	The prefix value must be formatted according to the RFC 2373 "IPv6 Addressing Architecture," using 8 colon-separated 16-bit hexadecimal values. One double colon may be used in the address to indicate the appropriate number of zeros required to fill the undefined fields.	None

**IPv6 Global Unicast Address**

Setting	Description	Factory Default
None	Displays the IPv6 Global Unicast address. The network portion of the Global Unicast address can be configured by specifying the Global Unicast Prefix and using an EUI-64 interface ID in the low order 64 bits. The host portion of the Global Unicast address is automatically generated using the modified EUI-64 form of the interface identifier (Switch's MAC address).	None

**IPv6 Link-Local Address**

Setting	Description	Factory Default
None	The network portion of the Link-Local address is FE80 and the host portion of the Link-Local address is automatically generated using the modified EUI-64 form of the interface identifier (Switch's MAC address).	None

**IPv6 Neighbor Cache**

The IPv6 neighbor cache includes the neighboring node's IPv6 address, the corresponding Link-Layer address, and the current state of the entry.

IPv6 Neighbor Cache		
IPv6 Address	Link Layer (MAC) Address	State
fe80::290:e8ff:fe02:406	00-90-e8-02-04-06	Reachable

**NOTE** The IPv6 feature only works on the PT-G7728.

## Date and Time

The Moxa switch has a time calibration function based on information from an NTP server or user specified time and date, allowing functions such as automatic warning emails to include a time and date stamp.

**NOTE** The user must update the Current Time and Current Date after powering off the switch for a long period of time (for example a few days). The user must pay particular attention to this when there is no time server, LAN, or Internet connection.

### System Time

System Up Time: 3d17h46m56s Refresh

Current Time: 2017/07/04 10:47:31

Time Zone: (GMT)Greenwich Mean Time: Dublin, Edinburgh, Lisbon, London ▼

**Daylight Saving**

Month	Week	Day	Hour
Start Date: -- ▼	-- ▼	-- ▼	-- ▼
End Date: -- ▼	-- ▼	-- ▼	-- ▼
Offset(hr): 0 ▼			

---

**Clock Source**

Local
  NTP
  SNTP
  PTP

**Time Settings**

Manual Time Settings

Date (YYYY/MM/DD): 2017 / 07 / 04

Time (HH:MM:SS): 10 : 47 : 31

Sync. from Local Device Time 2017/7/4 10:47:33

**NTP/SNTP Server Settings**

Enable NTP/SNTP Server

Apply

### System Up Time

Indicates how long the Moxa switch has been up and running since the last cold start.

### Current Time

Setting	Description	Factory Default
User-specified time	Indicates time in yyyy-mm-dd format.	None

### Clock Source

Setting	Description	Factory Default
Local	Configure clock source from local time	Local
NTP	Configure clock source from NTP	
SNTP	Configure clock source from SNTP	
PTP	Configure clock source from PTP	

### Time Zone

Setting	Description	Factory Default
Time zone	Specifies the time zone, which is used to determine the local time offset from GMT (Greenwich Mean Time).	GMT (Greenwich Mean Time)

## Daylight Saving Time

The Daylight Saving Time settings are used to automatically set the Moxa switch's time ahead according to national standards.

### Start Date

Setting	Description	Factory Default
User-specified date	Specifies the date that Daylight Saving Time begins.	None

### End Date

Setting	Description	Factory Default
User-specified date	Specifies the date that Daylight Saving Time ends.	None

### Offset

Setting	Description	Factory Default
User-specified hour	Specifies the number of hours that the time should be set forward during Daylight Saving Time.	None

**NOTE** Changing the time zone will automatically correct the current time. Be sure to set the time zone before setting the time.

If the NTP or SNTP options are enabled, you will also need to configure the following settings.

## Time Server IP / Name

Setting	Description	Factory Default
1st address or name of IP server	The IP or domain address (e.g., 192.168.1.1, time.stdtime.gov.tw, or time.nist.gov).	None
IP address or name of secondary time server	The Moxa switch will try to locate the secondary SNTP server if the first SNTP server fails to connect.	
Query Period	The time period to sync with time server	600secs

### Enable NTP/SNTP Server

Setting	Description	Factory Default
Enable/Disable	Enables SNTP/NTP server functionality for clients	Disabled



# NTP Authentication Settings

NTP authentication is used to authenticate the NTP time synchronization packet. When you enable the NTP authentication, the device synchronizes to a time source/client/peer only if the packet carries the authentication key. The device will drop the packet that fails the authentication and will not update the local time.

**Clock Source**       Local  NTP  SNTP  PTP

**NTP Authentication Settings**

Enable NTP Authentication

**Authentication Key ▼**

Key ID	Type	Key String	Trusted
<input type="text"/>	MD5	<input type="text"/>	<input type="checkbox"/>
<input type="text"/>	MD5	<input type="text"/>	<input type="checkbox"/>
<input type="text"/>	MD5	<input type="text"/>	<input type="checkbox"/>
<input type="text"/>	MD5	<input type="text"/>	<input type="checkbox"/>
<input type="text"/>	MD5	<input type="text"/>	<input type="checkbox"/>

Note: Key ID - Authentication key for trusted time sources (1~65535)

**NTP Client Settings**

Index	Time Server/Peer Address	Authentication
1	time.nist.gov	<input type="checkbox"/> <input type="text"/>
2	<input type="text"/>	<input type="checkbox"/> <input type="text"/>

**NTP/SNTP Server Settings**

Enable NTP/SNTP Server

**Apply**

Setting	Description
Enable NTP authentication	The NTP authentication will be enabled if the checkbox is selected

**Authentication Key:**

This part indicates the key that can be recognized by this device, and a maximum of 5 keys can be stored in the device. Users can activate the key by selecting the 'Trusted' checkbox.

Setting	Description
Key ID	Indicate the ID of the key Range: 1 to 65535, Maximum of 5 key IDs can be stored
Key String	Defines the authentication key
Trusted	If selected, the key will be activated

**NTP Client Settings**

Setting	Description
Time Server/Peer Address	The time server or peer to sync to the ntp
Authentication	Enter the key ID that you want to be used for authentication. The authentication key that user wants to be used to set the time

**NTP/SNTP Server settings**

Setting	Description
Enable NTP/SNTP Server	The device will be the NTP server if the checkbox selected.

## IEEE 1588

The following information is taken from the NIST website at <http://ieee1588.nist.gov/intro.htm>:

“Time measurement can be accomplished using the IEEE Standard for a Precision Clock Synchronization Protocol for Networked Measurement and Control Systems (IEEE 1588-2008) to synchronize real-time clocks incorporated within each component of the electrical power system for power automation applications.

IEEE 1588, which was published in November 2002, expands the performance capabilities of Ethernet networks to control systems that operate over a communication network. In recent years an increasing number of electrical power systems have been using a more distributed architecture with network technologies that have less stringent timing specifications. IEEE 1588 generates a master-slave relationship between the clocks, and enforces the specific timing requirements in such power systems. All devices ultimately get their time from a clock known as the grandmaster clock. In its basic form, the protocol is intended to be administration free.”

### How Does an Ethernet Switch Affect 1588 Synchronization?

The following content is taken from the NIST website at <http://ieee1588.nist.gov/switch.htm>:

“An Ethernet switch potentially introduces multi-microsecond fluctuations in the latency between the 1588 grandmaster clock and a 1588 slave clock. Uncorrected these fluctuations will cause synchronization errors. The magnitude of these fluctuations depends on the design of the Ethernet switch and the details of the communication traffic. Experiments with prototype implementations of IEEE 1588 indicate that with suitable care the effect of these fluctuations can be successfully managed. For example, use of appropriate statistics in the 1588 devices to recognize significant fluctuations and use suitable averaging techniques in the algorithms controlling the correction of the local 1588 clock will be good design means to achieve the highest time accuracy.”

### Can Ethernet switches be designed to avoid the effects of these fluctuations?

A switch can be designed to support IEEE 1588 while avoiding the effects of queuing. In this case two modifications to the usual design of an Ethernet switch are necessary:

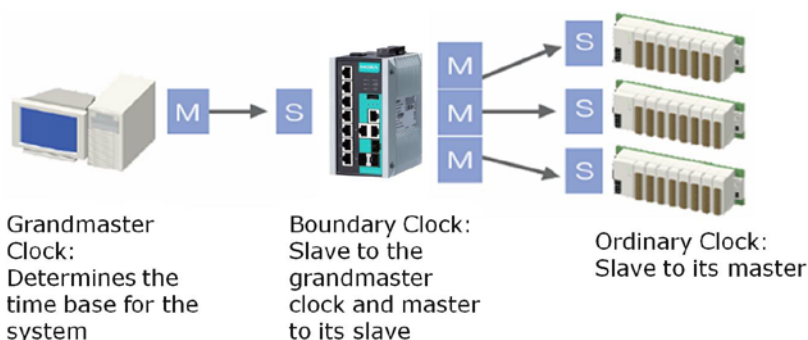

1. The **Boundary Clock and Transparent Clock** functionalities defined by IEEE 1588 must be implemented in the switch.
2. The switch must be configured so that it does not pass IEEE 1588 message traffic using the normal communication mechanisms of the switch.

Such an Ethernet switch will synchronize clocks directly connected to one of its ports to the highest possible accuracy.

## PTP Settings

**PTP Settings**

Enable IEEE 1588 PTP

Apply

**Enable IEEE 1588 PTP**

Setting	Description	Factory Default
Enable/Disable	Enable or disable the IEEE 1588 PTP feature globally.	Disabled

**NOTE** When using IEEE 1588 PTP, please go to PTP port settings to enable the PTP feature on each port as well.

**PTP Profile**

Setting	Description	Factory Default
Default Profile	Configure as 'PTP default profile' which is defined in IEEE Std 1588-2008, Annex J.	Default Profile
Power Profile	Configure as 'PTP power profile' which is defined in IEEE C37.238-2011.	

**Default profile**

**PTP Settings**

Enable IEEE 1588 PTP      PTP Profile Default Profile ▼

**Global Settings**

PTP Device Type V2 BC (Boundary Clock) ▼

Path Delay Mechanism P2P ▼

Clock Mode One-Step ▼

**Clock Settings**

Sync Interval	<span style="border: 1px solid #ccc; padding: 2px;">0 (1s) ▼</span>	Clock Class	<span style="border: 1px solid #ccc; padding: 2px;">248</span> (0~255)
Announce Interval	<span style="border: 1px solid #ccc; padding: 2px;">1 (2s) ▼</span>	Clock Accuracy	<span style="border: 1px solid #ccc; padding: 2px;">0x21 ▼</span>
Announce Timeout	<span style="border: 1px solid #ccc; padding: 2px;">3 ▼</span>	Timescale Type	PTP
PDelay-Request Minimum Interval	<span style="border: 1px solid #ccc; padding: 2px;">0 (1s) ▼</span>	UTC Offset Valid	<span style="border: 1px solid #ccc; padding: 2px;">FALSE ▼</span>
Domain Number	<span style="border: 1px solid #ccc; padding: 2px;">0</span> (0~255)	UTC Offset	<span style="border: 1px solid #ccc; padding: 2px;">36</span> seconds
Transport Mode	<span style="border: 1px solid #ccc; padding: 2px;">802.3 ▼</span>		
Priority1	<span style="border: 1px solid #ccc; padding: 2px;">128</span> (0~255)		
Priority2	<span style="border: 1px solid #ccc; padding: 2px;">128</span> (0~255)		

Apply

## Global settings

**PTP Device Type**

Setting	Description	Factory Default
V2 BC (Boundary Clock)	Operates as an IEEE 1588 PTP v2 boundary clock.	V2 TC (Transparent Clock)
V2 TC (Transparent Clock)	Operates as an IEEE 1588 PTP v2 transparent clock.	

**Clock Mode**

Setting	Description	Factory Default
One-step	Configure as a one-step clock.	One-step
Two-step	Configure as a two-step clock.	

**PTP Delay Mechanism**

Setting	Description	Factory Default
P2P	Configure as the peer-to-peer method. Power profile (C37.238) requires the peer-to-peer method.	P2P
E2E	Configure as the end-to-end method, which measures the propagation time between two PTP ports.	

**NOTE** Please make sure all PTP devices are configured to the same PTP Delay Mechanism.

**Clock settings**

**Sync Interval**

Setting	Description	Factory Default
-3 (128ms), -2 (256ms), -1 (512ms), 0 (1 sec), 1 (2 sec)	Configure synchronization message time interval.	0 (1 sec)

**Announce Interval**

Setting	Description	Factory Default
0 (1 sec), 1 (2 sec), 2 (4 sec), 3 (8 sec), 4 (16 sec)	Configure the mean time interval between successive Announce messages.	1 (2 sec)

**Announce Timeout**

Setting	Description	Factory Default
2 to 10 (times announce interval)	Configure the number of Announce Interval messages that were not received, before the master clock changes.	3

**PDelay-Request Minimum Interval**

Setting	Description	Factory Default
-1 (512ms), 0 (1 sec), 1 (2 sec), 2 (4 sec), 3 (8 sec), 4 (16 sec), 5 (32 sec)	Configure the minimum permitted mean time interval between successive Pdelay_Req messages of the P2P mode.	0 (1 sec)

**Domain Number**

Setting	Description	Factory Default														
0 to 255	A domain defines the scope of communication, state, operations, data sets, and timescale of the the PTP message.	0														
<table border="1"> <thead> <tr> <th>Value(decimal)</th> <th>Definition</th> </tr> </thead> <tbody> <tr> <td>0</td> <td>Default domain</td> </tr> <tr> <td>1</td> <td>Alternate domain 1</td> </tr> <tr> <td>2</td> <td>Alternate domain 2</td> </tr> <tr> <td>3</td> <td>Alternate domain 3</td> </tr> <tr> <td>4 to 127</td> <td>User-defined domains</td> </tr> <tr> <td>128 to 255</td> <td>Reserved</td> </tr> </tbody> </table>			Value(decimal)	Definition	0	Default domain	1	Alternate domain 1	2	Alternate domain 2	3	Alternate domain 3	4 to 127	User-defined domains	128 to 255	Reserved
Value(decimal)	Definition															
0	Default domain															
1	Alternate domain 1															
2	Alternate domain 2															
3	Alternate domain 3															
4 to 127	User-defined domains															
128 to 255	Reserved															

**NOTE** The switch and the grandmaster clock must be in the same PTP domain.

#### *Transport Mode*

Setting	Description	Factory Default
802.3	Configure PTP implementations directly using Ethernet format.	Default Profile: 802.3;
IPv4	Configure PTP implementations using UDP/IPv4 as a communication service.	Power Profile: fixed to 802.3 as C37.238 required

**NOTE** Please make sure all PTP devices are using the same communication service.

#### *Priority1*

Setting	Description	Factory Default
0 to 255	Lower values take precedence. PTP power profile (C37.238) defines that value 128 is for grandmaster-capable devices; Value 255 is only for slave devices.	128

#### *Priority2*

Setting	Description	Factory Default
0 to 255	Lower values take precedence. PTP power profile (C37.238) defines that value 128 is for grandmaster-capable device; Value 255 is only for slave devices.	128

#### *Clock Class*

Setting	Description	Factory Default
0 to 255	The clock class attribute of an ordinary or boundary clock denotes the traceability of the time or frequency distributed by the grandmaster clock. Value 248 is used as default if none of the other clock class definitions apply.	248

#### *Clock Accuracy*

Setting	Description	Factory Default
0x20 to 0x31, 0xFE	The clock accuracy indicates the expected accuracy of a clock when it is the grandmaster. IEEE 1588 PTP defines value 0x21 for time accuracy within 100ns. The value 0xFE is for unknown.	0x21 (100 ns)

#### *Timescale Type*

Setting	Description	Factory Default
PTP	Under normal operations, the epoch is the PTP epoch. The time unit is SI (International System) seconds.	PTP

#### *UTC Offset Valid*

Setting	Description	Factory Default
FALSE/TRUE	In PTP systems whose epoch is the PTP epoch, the value of UTC offset is the offset between TAI (International Atomic Time) and UTC (Coordinated Universal Time). The value of the UTC offset is TRUE if the UTC offset is known to be correct; otherwise, it is FALSE.	FALSE

#### *UTC Offset*

Setting	Description	Factory Default
0 to 65535 seconds	The offset between the UTC clock and TAI is 37 seconds @ Jan, 2017	37

**Power Profile**

### PTP Settings

Enable IEEE 1588 PTP      PTP Profile Power Profile ▼

**Global Settings**

PTP Device Type V2 BC (Boundary Clock) ▼      Clock Mode One-Step ▼  
 Path Delay Mechanism P2P ▼

---

VLAN ID 0 (0~4094)      Class of Service 4 (0~7)  
 Grandmaster ID 255       Check Announce TLV

**Clock Settings**

Sync Interval 0 (1s) ▼      Clock Class 248 (0~255)  
 Announce Interval 1 (2s) ▼      Clock Accuracy 0x21 ▼  
 Announce Timeout 3 ▼      Timescale Type PTP  
 PDelay-Request Minimum Interval 0 (1s) ▼      UTC Offset Valid FALSE ▼  
 Domain Number 0 (0~255)      UTC Offset 36 seconds  
 Transport Mode 802.3 ▼  
 Priority1 128 (0~255)  
 Priority2 128 (0~255)

Apply

**Global settings**

**VLAN ID**

Setting	Description	Factory Default
0 to 4094	Only available in Power Profile mode. The reserved value 0 indicates that only the priority tag in 802.1Q is considered. This value should be match to VLAN rules where the enabled PTP feature applies to the whole system. Please also take note of the VLAN setting of the device.	0

**Class of Service**

Setting	Description	Factory Default
0 to 7	Only available in Power Profile mode. Configure as an 802.1p priority tag. Lower values take precedence.	4

**Grandmaster ID**

Setting	Description	Factory Default
0 to 255	Only available in Power Profile mode. Configure grandmaster ID to identify the grandmaster clock source.	255

**Check Announce TLV**

Setting	Description	Factory Default
Enable/Disable	Only available in Power Profile mode. When the profile type is Power profile, the switch will not handle the PTP announce messages which do not include length and value (TLV) extensions: Organization_extension and Alternate_timescale. Configure 'Check announce TLV' to enable or disable announce TLV checking.	Enabled

## PTP Port Settings

PTP Port Settings		
Port	Enable	Status
1	<input checked="" type="checkbox"/>	PTP_DISABLED
2	<input checked="" type="checkbox"/>	PTP_DISABLED (Link Down)
3	<input checked="" type="checkbox"/>	PTP_MASTER
4	<input checked="" type="checkbox"/>	PTP_SLAVE
1-1	<input checked="" type="checkbox"/>	PTP_MASTER
1-2	<input type="checkbox"/>	PTP_DISABLED
1-3	<input type="checkbox"/>	PTP_DISABLED
1-4	<input type="checkbox"/>	PTP_DISABLED

**NOTE** When enabling the PTP feature on each port, please also enable the 'Enable IEEE 1588 PTP' on 'PTP settings' .

### PTP Port settings

Setting	Description	Factory Default
Enable/Disable	PTP port status: <ul style="list-style-type: none"> <li>PTP_INITIALIZING: PTP port is initializing. No PTP messages on its communication path.</li> <li>PTP_MASTER: The port is the source of time on the path served by the port.</li> <li>PTP_DISABLED: A port in this state will not handle any PTP received messages except for management messages.</li> <li>PTP_PASSIVE: The port is not the master on the path nor does it synchronize to a master.</li> <li>PTP_LISTENING: The port is waiting for the announce timeout interval to expire or to receive an Announce message from a master.</li> <li>PTP_SLAVE: The port is synchronizing to the selected PTP master port.</li> </ul>	PTP disabled

## PTP Status

Indicates the current IEEE 1588 PTP status.

PTP Status	
PTP Service:	Enabled
PTP Mode:	V2 - P2P - One-Step - TC
PTP Profile:	Power Profile
Transport Mode:	802.3 (Ethernet)
PTP Slave Port:	3
<b>Clock Status</b>	
Local Clock Identity:	00:90:E8:FF:FE:55:66:99
Mean Path Delay(Slave Port):	312

## Warning Notification

Since industrial Ethernet devices are often located at the endpoints of a system, these devices will not always know what is happening elsewhere on the network. This means that an industrial Ethernet switch that connects to these devices must provide system maintainers with real-time alarm messages. Even when control engineers are out of the control room for an extended period of time, they can still be informed of the status of devices almost instantaneously when exceptions occur. The Moxa switch supports different approaches to warn engineers automatically, such as email, trap, syslog and relay output. It also supports two digital inputs to integrate sensors into your system to automate alarms by email and relay output.

## System Event Settings

System Events are related to the overall function of the switch. Each event can be activated independently with different warning approaches. The Administrator can decide the severity of each system event.

### System Event Settings

<input type="checkbox"/>	Event	Action					Severity
		Trap	E-Mail	Syslog	Relay1	Relay2	
<input checked="" type="checkbox"/>	Cold Start	<input checked="" type="checkbox"/>	<input type="checkbox"/>	<input checked="" type="checkbox"/>			Critical ▼
<input checked="" type="checkbox"/>	Warm Start	<input checked="" type="checkbox"/>	<input type="checkbox"/>	<input checked="" type="checkbox"/>			Warning ▼
<input checked="" type="checkbox"/>	Config. Changed	<input checked="" type="checkbox"/>	<input type="checkbox"/>	<input checked="" type="checkbox"/>			Warning ▼
<input checked="" type="checkbox"/>	PWR 1 Off->On	<input checked="" type="checkbox"/>	<input type="checkbox"/>	<input checked="" type="checkbox"/>			Warning ▼
<input checked="" type="checkbox"/>	PWR 2 Off->On	<input checked="" type="checkbox"/>	<input type="checkbox"/>	<input checked="" type="checkbox"/>			Warning ▼
<input checked="" type="checkbox"/>	PWR 1 On->Off	<input checked="" type="checkbox"/>	<input type="checkbox"/>	<input checked="" type="checkbox"/>	<input type="checkbox"/>	<input type="checkbox"/>	Warning ▼
<input checked="" type="checkbox"/>	PWR 2 On->Off	<input checked="" type="checkbox"/>	<input type="checkbox"/>	<input checked="" type="checkbox"/>	<input type="checkbox"/>	<input type="checkbox"/>	Warning ▼
<input checked="" type="checkbox"/>	Login Success	<input checked="" type="checkbox"/>	<input type="checkbox"/>	<input checked="" type="checkbox"/>			Warning ▼
<input checked="" type="checkbox"/>	Login Fail	<input checked="" type="checkbox"/>	<input type="checkbox"/>	<input checked="" type="checkbox"/>			Warning ▼
<input checked="" type="checkbox"/>	TACACS+ Auth. Success	<input checked="" type="checkbox"/>	<input type="checkbox"/>	<input checked="" type="checkbox"/>			Warning ▼
<input checked="" type="checkbox"/>	TACACS+ Auth. Fail	<input checked="" type="checkbox"/>	<input type="checkbox"/>	<input checked="" type="checkbox"/>			Warning ▼

System Events	Description
Cold Start	Power is cut off and then reconnected.
Warm Start	The Moxa switch is rebooted, such as when network parameters are changed (IP address, subnet mask, etc.).
Configuration Change	Any configuration item has been changed.
Power Transition (On→Off)	The Moxa switch is powered down.
Power Transition (Off→On)	The Moxa switch is powered up.
Login Success	The account logs in to the switch
Login Fail	An incorrect password was entered.
TACACS+ Auth. Success	The account is authorized by a TACACS+ server
TACACS Auth. Fail	Incorrect authentication details were entered
RADIUS Auth. Success	The account is authorized by a RADIUS server
RADIUS Authentication Fail	Incorrect authentication details were entered
Password Change	User changes the account password



System Events	Description
Topology Changed	<ul style="list-style-type: none"> <li>If the Master of the Turbo Ring has changed or the backup path is activated</li> <li>If the Turbo Ring path is disconnected</li> <li>If the MSTP topology has changed</li> </ul>
Coupling Changed	Backup path is activated
Master Changed	Master of the Turbo Ring has changed
Master Mismatch	When the duplicate master (two or more) or non-master is set up, if any Turbo Ring path/switch fails, the duplicate master switches will automatically renegotiate to determine a new master.
RSTP Root Changed	If the RSTP root has changed
RSTP Topo. Changed	If any Rapid Spanning Tree Protocol switches have changed their position (applies only to the root of the tree)
Turbo Ring Break	Turbo Ring path is disconnected
ABC-02 Status	Detects if the ABC-02-USB-T is connected or disconnected to the switch when the ABC-02-USB-T automatically imports/exports/back-up the configuration
Rate Limited On (Disable Port)	When the port is disabled due to the ingress throughput exceeding the configured rate limit.
Rate Limited Off (Disable Port)	The port disable function is off because it exceeds the traffic duration or the user changes "Port Disable" mode to "Drop Packet" mode.
Port Looping	Port looping event is triggered
LLDP Table Change	Nearly connected devices are changed and shown in the LLDP table
Login Failure Lockout	The attempt to log in exceeds the threshold
Account Info Changed	The account information has been changed
Configuration is Imported	When the configuration is successfully imported
SSL Certification is Imported	When SSL Certification is successfully imported
Fiber Check Warning	If the corresponding value of the fiber port status exceeds the threshold defined by the Fiber Check function
MAC Sticky Violation Port Disable	Any port with MAC sticky function is disabled because of a rule violation
Port module inserted	The module is inserted to the system
Port module removed	The module is removed from the system
Port module unrecognized	The module inserted is not recognized by the system
Dual image fail	One of the image has failed
Tracking Status Changed	The tracking status has changed
Port Enable Tracking Changed	The tracking status has changed and reacts on Port Enable
Static Route Tracking Changed	The tracking status has changed and reacts on Static Route
VRRP Tracking Changed	The tracking status has changed and reacts on VRRP priority
EPS Off->On	The external power supply for PoE is on
EPS On->Off	The external power supply for PoE is off
GOOSE Check Event	The GOOSE check status has changed
Dying Gasp	When power input of power module is lower the system uptime threshold the dying gasp function will be activated. This event will only activate before the whole system powers off.

Four response actions are available when events are triggered.

Action	Description
Trap	A notification will be sent to the trap server when an event is triggered.
E-Mail	A notification will be sent to the email server defined in the Email Setting.
Syslog	A notification will be sent to the syslog server defined in Syslog Server Setting.

Relay	Supports digital inputs to integrate sensors. When an event is triggered, the device will automate alarms through the relay output.
-------	---

**Severity**

Severity	Description
Emergency	System is unusable
Alert	Action must be taken immediately
Critical	Critical conditions
Error	Error conditions
Warning	Warning conditions
Notice	Normal but significant condition
Information	Informational messages
Debug	Debug-level messages

**Port Event Settings**

Port Events are related to the activity of a specific port.

**Port Event Settings**

<input type="checkbox"/>	Port	Link		Traffic			Action					Severity
		<input type="checkbox"/>	<input type="checkbox"/>	<input type="checkbox"/>	RX-Threshold (%)	Traffic-Duration (s)	<input type="checkbox"/>	<input type="checkbox"/>	<input type="checkbox"/>	<input type="checkbox"/>	<input type="checkbox"/>	
<input checked="" type="checkbox"/>	1	<input checked="" type="checkbox"/>	<input checked="" type="checkbox"/>	<input type="checkbox"/>	0	1	<input checked="" type="checkbox"/>	<input type="checkbox"/>	<input checked="" type="checkbox"/>	<input type="checkbox"/>	<input type="checkbox"/>	Warning ▼
<input checked="" type="checkbox"/>	2	<input checked="" type="checkbox"/>	<input checked="" type="checkbox"/>	<input type="checkbox"/>	0	1	<input checked="" type="checkbox"/>	<input type="checkbox"/>	<input checked="" type="checkbox"/>	<input type="checkbox"/>	<input type="checkbox"/>	Warning ▼
<input checked="" type="checkbox"/>	3	<input checked="" type="checkbox"/>	<input checked="" type="checkbox"/>	<input type="checkbox"/>	0	1	<input checked="" type="checkbox"/>	<input type="checkbox"/>	<input checked="" type="checkbox"/>	<input type="checkbox"/>	<input type="checkbox"/>	Warning ▼
<input checked="" type="checkbox"/>	4	<input checked="" type="checkbox"/>	<input checked="" type="checkbox"/>	<input type="checkbox"/>	0	1	<input checked="" type="checkbox"/>	<input type="checkbox"/>	<input checked="" type="checkbox"/>	<input type="checkbox"/>	<input type="checkbox"/>	Warning ▼
<input checked="" type="checkbox"/>	1-1	<input checked="" type="checkbox"/>	<input checked="" type="checkbox"/>	<input type="checkbox"/>	0	1	<input checked="" type="checkbox"/>	<input type="checkbox"/>	<input checked="" type="checkbox"/>	<input type="checkbox"/>	<input type="checkbox"/>	Warning ▼
<input checked="" type="checkbox"/>	1-2	<input checked="" type="checkbox"/>	<input checked="" type="checkbox"/>	<input type="checkbox"/>	0	1	<input checked="" type="checkbox"/>	<input type="checkbox"/>	<input checked="" type="checkbox"/>	<input type="checkbox"/>	<input type="checkbox"/>	Warning ▼
<input checked="" type="checkbox"/>	1-3	<input checked="" type="checkbox"/>	<input checked="" type="checkbox"/>	<input type="checkbox"/>	0	1	<input checked="" type="checkbox"/>	<input type="checkbox"/>	<input checked="" type="checkbox"/>	<input type="checkbox"/>	<input type="checkbox"/>	Warning ▼
<input checked="" type="checkbox"/>	1-4	<input checked="" type="checkbox"/>	<input checked="" type="checkbox"/>	<input type="checkbox"/>	0	1	<input checked="" type="checkbox"/>	<input type="checkbox"/>	<input checked="" type="checkbox"/>	<input type="checkbox"/>	<input type="checkbox"/>	Warning ▼
<input checked="" type="checkbox"/>	2-1	<input checked="" type="checkbox"/>	<input checked="" type="checkbox"/>	<input type="checkbox"/>	0	1	<input checked="" type="checkbox"/>	<input type="checkbox"/>	<input checked="" type="checkbox"/>	<input type="checkbox"/>	<input type="checkbox"/>	Warning ▼

Port Events	Warning e-mail is sent when...
Link-ON	The port is connected to another device.
Link-OFF	The port is disconnected (e.g., the cable is pulled out, or the opposing device shuts down).
Traffic-Overload	The port's traffic surpasses the Traffic-Threshold for that port (provided this item is Enabled).
Traffic-Threshold (%)	Enter a nonzero number if the port's Traffic-Overload item is Enabled.
Traffic-Duration (sec.)	A Traffic-Overload warning is sent every Traffic-Duration seconds if the average Traffic-Threshold is surpassed during that time period.

Four response actions are available on the EDS E series when events are triggered.

Action	Description
Trap	A notification will be sent to the trap server when an event is triggered.
E-Mail	A notification will be sent to the email server defined in the Email Setting.

Syslog	A notification will be sent to the syslog server defined in Syslog Server Setting.
Relay	Supports digital inputs to integrate sensors. When an event is triggered, the device will automate alarms through the relay output.

**Severity**

Severity	Description
Emergency	System is unusable
Alert	Action must be taken immediately
Critical	Critical conditions
Error	Error conditions
Warning	Warning conditions
Notice	Normal but significant condition
Information	Informational messages
Debug	Debug-level messages

**NOTE** The Traffic-Overload, Traffic-Threshold (%), and Traffic-Duration (sec.) Port Event items are related. If you Enable the Traffic-Overload event, then be sure to enter a nonzero Traffic-Threshold percentage, as well as a Traffic-Duration between 1 and 300 seconds.

**Event Log Settings**

This function is used to inform the user what the event log capacity status is and decide what action to take when an event log is oversized. Select the **Enable Log Capacity Warning** checkbox to set the threshold percentage. When the event log capacity is over the percentage, the switch will send a warning message by SNMP Trap or Email.

**Event Log Settings**

**Enable Log Capacity Warning at**  (%)

Warning By:  SNMP Trap  Email

**Event Log Oversize Action :**

**Event Log Oversize Action**

Setting	Description	Factory Default
Overwrite The Oldest Event Log	The oldest event log will be overwritten when the event log exceeds 1000 records.	Overwrite The Oldest Event Log
Stop Recording Event Log	Additional events will not be recorded when the event log exceeds 1000 records.	

## Email Settings

**Email Setup**

Mail Server

TCP Port

User Name

Password

Sender Address

Use TLS  ▼

SMTP Server Auth Method  ▼

1st Recipient Email Address

2nd Recipient Email Address

3rd Recipient Email Address

4th Recipient Email Address

### Mail Server

Setting	Description	Factory Default
IP address or url	The IP Address or url of the email server.	None

### TCP Port

Setting	Description	Factory Default
TCP Port number	The TCP port number of your email server.	25

### User Name

Setting	Description	Factory Default
Max. of 45 characters	Your email account name	None

### Password Setting

Setting	Description	Factory Default
Password	The email account password.	None

### Email Address

Setting	Description	Factory Default
Max. of 30 characters	You can set up to 4 email addresses to receive alarm emails from the Moxa switch.	None

### Sender Address

Setting	Description	Factory Default
Max. 30 characters	Sender Email Address	admin@localhost

### User TLS

Setting	Description	Factory Default
Yes/No	Enables TLS(Transport Layer Security)	No

### SMTP Server Auth Method

Setting	Description	Factory Default
Plain/Login/ CRAM-MD5	choose an authentication mechanism, PLAIN, LOGIN, and CRAM-MD5, to login SMTP Server	Plain

### Sending a Test Email

After you complete the email settings, you should first click **Apply** to activate those settings, and then press the **Test** button to verify that the settings are correct.

**NOTE** Auto warning e-mail messages will be sent through an authentication protected SMTP server that supports the CRAM-MD5, LOGIN, and PAIN methods of SASL (Simple Authentication and Security Layer) authentication mechanism.  
We strongly recommend not entering your Account Name and Account Password if auto warning e-mail messages can be delivered without using an authentication mechanism.

## Syslog Server Settings

The Syslog function provides the event logs for the syslog server. The function supports 3 configurable syslog servers and syslog server UDP port numbers. When an event occurs, the event will be sent as a syslog UDP packet to the specified syslog servers. Each Syslog server can be activated separately by checking the appropriate checkbox to enable it.

**Syslog Settings**

Syslog 1

Server

UDP Port  (1~65535)

Syslog 2

Server

UDP Port  (1~65535)

Syslog 3

Server

UDP Port  (1~65535)

[Apply](#)

### Syslog Server 1/2/3

Setting	Description	Factory Default
IP Address	Enter the IP address of Syslog server 1/2/3, used by your network.	None
Port Destination (1 to 65535)	Enter the UDP port of Syslog server 1/2/3.	514

**NOTE** The following events will be recorded into the Moxa switch’s Event Log table, and will then be sent to the specified Syslog Server:

- Cold start
- Warm start
- Configuration change activated
- Power 1 or 2 transition: Off to On or On to Off
- Authentication fail
- Password change
- Redundancy protocol/topology change
- Master setting mismatch
- ABC-02 status
- Web log in
- Rate Limit on/off(Disable port)
- Port looping
- Port traffic overload
- dot1x Auth Fail
- Port link off/on

## Relay Warning Status

When a relay warning is triggered by either the system or port events, the administrator can turn off the hardware warning buzzer by clicking the **Apply** button. The event will still be recorded in the event list.

### Relay Warning Status

Relay 1 Alarm Cut-Off (ACO)

Apply

Index	Event	Relay
-------	-------	-------

## MAC Address Table

The MAC address table shows the MAC address list passed through the Moxa switch. The Aging Time (15 to 3825 seconds) defines the length of time that a MAC address entry can remain in the Moxa switch. When an entry reaches its aging time, it “ages out” and is purged from the switch, effectively cancelling frame forwarding to that specific port.

The MAC Address table can be configured to display the following Moxa switch MAC address groups, which are selected from the drop-down list.

### MAC Address Table

Aging Time (sec)  Apply

---

All ▼
Page 1/4 ▼

Index	MAC	Type	VLAN	Port
1	64-51-06-4e-9c-1b	Unicast(I)	1	7
2	10-6f-3f-df-cc-86	Unicast(I)	1	7
3	00-14-fd-14-e2-54	Unicast(I)	1	7
4	00-0c-29-56-95-49	Unicast(I)	1	7
5	e4-11-5b-34-b9-b6	Unicast(I)	1	7
6	40-8d-5c-4d-ef-89	Unicast(I)	1	7
7	64-51-06-4a-3b-be	Unicast(I)	1	7
8	74-03-bd-ae-38-3a	Unicast(I)	1	7
9	00-26-18-33-11-d6	Unicast(I)	1	7
10	68-f7-28-df-ca-d7	Unicast(I)	1	7

### Drop Down List

<b>ALL</b>	Select this item to show all of the Moxa switch’s MAC addresses.
<b>ALL Learned</b>	Select this item to show all of the Moxa switch’s Learned MAC addresses.
<b>ALL Static</b>	Select this item to show all of the Moxa switch’s Static, Static Lock, and Static Multicast MAC addresses.
<b>ALL Multicast</b>	Select this item to show all of the Moxa switch’s Static Multicast MAC addresses.
<b>Port x</b>	Select this item to show all of the MAC address’s dedicated ports.

The table displays the following information:

<b>MAC</b>	This field shows the MAC address.
<b>Type</b>	This field shows the type of this MAC address.
<b>Port</b>	This field shows the port that this MAC address belongs to.

# System Files

## Firmware Upgrade

There are three ways to update your Moxa switch's firmware: from a local \*.rom file, by remote TFTP server, and with Auto Backup Configurator (ABC-02).

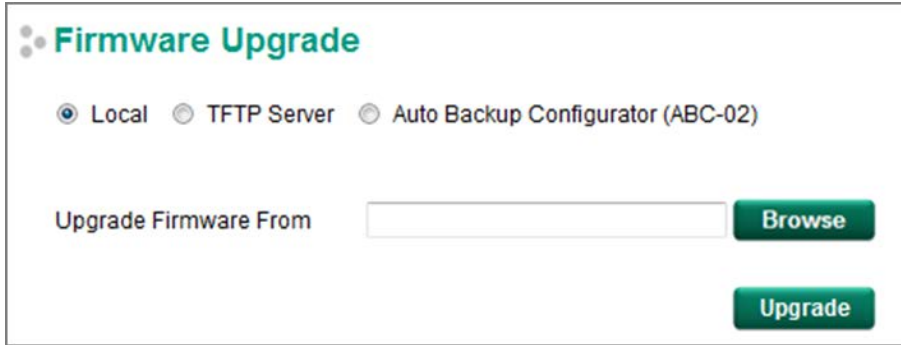

### Local

1. Download the updated firmware (\*.rom) file from Moxa's website ([www.moxa.com](http://www.moxa.com)).
2. Browse for the (\*.rom) file, and then click the **Upgrade** button

### TFTP Server

1. Enter the TFTP Server's IP address.
2. Input the firmware file name (\*.rom) and click the **Upgrade** button.

### Auto Backup Configurator (ABC-02)

1. Download the updated firmware (\*.rom) file from Moxa's website ([www.moxa.com](http://www.moxa.com)).
2. Save the file to the ABC-02's **Moxa** folder. The file name cannot be longer than 8 characters, and the file extension must be **.rom**.
3. Browse for the firmware (\*.rom) file from the ABC-02, and then click the **Upgrade** button.

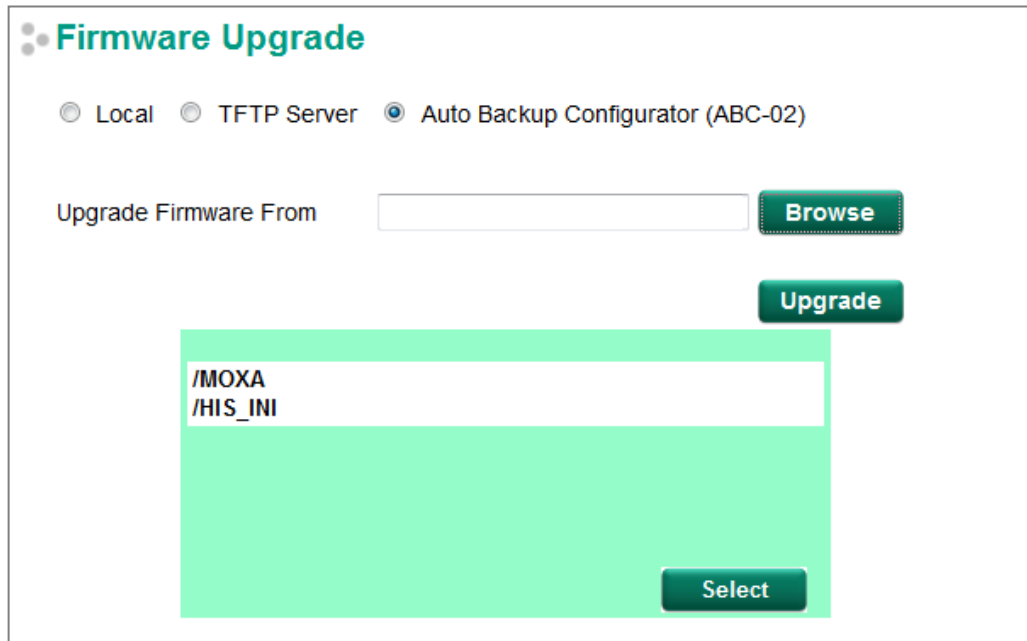

## Configuration Backup and Restore

There are three ways to back up and restore your Moxa switch's configuration: from a local configuration file, by remote TFTP server, and with Auto Backup Configurator (ABC-02).

### Local

1. Click the **Backup** button to back up the configuration file to a local drive.
2. Browse for a configuration on a local disk, and then click the **Restore** button.

### TFTP Server

1. Enter the TFTP Server's IP address.
2. Input the backup/restore file name (supports up to 54 characters, including the .ini file extension) and then click the **Backup/Restore** button.

### Auto Backup Configurator (ABC-02)

1. Click **Backup** to save the configuration file to the ABC-02. The file will be saved in the ABC-02's **Moxa** folder as a \*.ini file (e.g., Sys.ini).

Note that two files will be saved to the ABC-02-USB's **Moxa** folder: **Sys.ini** and **MAC.ini**. The purpose of saving the two files is to identify which file will be used when **Auto load configuration from ABC to system when boot up** is activated.

**NOTE** MAC.ini is named using the last 6 digits of the switch's MAC address, without spaces.

2. Click **Browse** to select the configuration file, and then click **Restore** to start loading the configuration into your switch.
3. **Configuration File Encryption Setting**  
Select the **Configuration File Encryption Setting** checkbox, input the password, and then click **Apply**.
4. **Auto load configuration from ABC to system when boot up**  
Select the **Auto load configuration from ABC to system when boot up** checkbox and then click **Apply**. Note that this function is enabled by default.

Power off your switch first, and then plug in the ABC-02. When you power on your switch, the system will detect the configuration file on the ABC-02 automatically. The switch will recognize the file name, with the following sequence priority:



First priority: MAC.ini

Second priority: Sys.ini

If no matching configuration file is found, the fault LED light will turn on, and the switch will boot up normally.

**NOTE** MAC.ini is named using the last 6 digits of the switch's MAC address, without spaces.

#### 5. Auto backup to ABC-02 when configuration changes

Select the **Auto backup to ABC-02 when configuration change** checkbox and then click **Apply**. This function is disabled by default.

The ABC-02 is capable of backing up switch configuration files automatically. While the ABC-02 is plugged into the switch, enable the **Auto backup to ABC-02 when configuration change** option, and then click **Apply**. Once this configuration is modified, the switch will back up the current configuration to the **/His\_ini** folder on the ABC-02. The file name will be the system date/time (MMDDHHmm.ini).

**NOTE** MM=month, DD=day, HH=hour, mm=minutes, from the system time.

## Log File Backup

There are three ways to back up Moxa switch's log files: from a local drive, by remote TFTP server, or with Auto Backup Configurator (ABC-02).

### Local

Click the **Backup** button to back up the log file to a local drive.

### TFTP Server

Enter the TFTP Server's IP address and file name and then click the Backup button.

### Auto Backup Configurator (ABC-02)

Click **Backup** to save the configuration file to the ABC-02. The file will be saved in the ABC-02's **Moxa** folder with filename **Sys.ini**.

### Auto backup of event log to prevent overwrite

This function is designed to maintain a long-term record of the switch's log files. Moxa Ethernet switches are capable of saving 1000 event log entries. When the 1000-entry storage limit is reached, the switch will delete the oldest saved event log. The ABC-02 can be used to back up these event logs. When the number of switch log entries reaches 1000, the ABC-02 will save the oldest 100 entries from the switch.

Enable the **Auto backup of event log to prevent overwrite**, and then click **Apply**. After that, when the ABC-02 is plugged into the switch, the event logs will always be saved to the ABC-02 automatically when the number of switch log entries reaches 1000. Each backup action saves the oldest 100 logs to the ABC-02 in one file, with the filename generated by the current system time as **MMDDHHmm.ini**. The file is saved to the **His\_log** folder.

**NOTE** Note: MM=month, DD=day, HH=hour, mm=minutes, from the system time.

The log file includes the following information:

<b>Index</b>	An event index assigned to identify the event sequence.
<b>Bootup Number</b>	This field shows how many times the Moxa switch has been rebooted or cold started.
<b>Date</b>	The date is updated based on how the current date is set on the System Settings page.
<b>Time</b>	The time is updated based on how the current time is set on the System Settings page.
<b>System Startup Time</b>	The system startup time related to this event.
<b>Event</b>	Events that have occurred.

## Switch Reset Button

The Moxa switch reset button can be used to perform two functions: quickly reset the switch's configuration and save the current configuration and log files to the ABC-02. Please refer to the QIG for how to use the ABC-02.

**NOTE** DO NOT remove the ABC-02 when performing an upgrade, backup, or restore.

## Restart

The **Restart** function provides users with a quick way to restart the switch's operating system.



## Factory Default

The **Factory Default** function provides users with a quick way of restoring the Moxa switch's configuration to factory defaults. The function can be activated from the USB serial interface, via Telnet, through the web-based console, or with the hardware reset button.

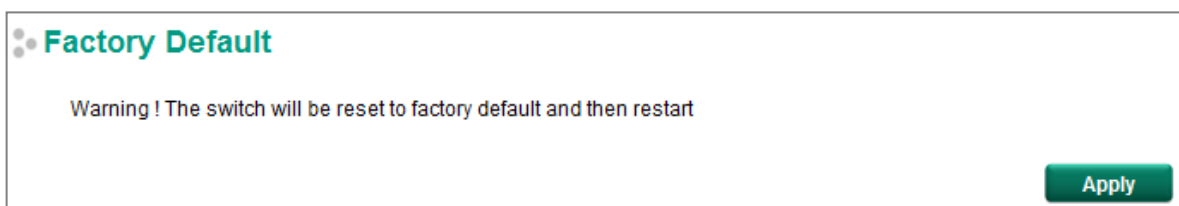

**NOTE** After restoring the factory default configuration, you will need to use the default network settings to re-establish the web or Telnet console connection with the Moxa switch.

# PoE (PoE Models Only)

Power over Ethernet has become increasingly popular, due in large part to the reliability provided by PoE Ethernet switches that supply the power to Powered Devices (PD) when AC power is not available, or is too expensive to provide locally.

Power over Ethernet can be used with the following types of devices:

- Surveillance cameras
- Security I/O sensors
- Industrial wireless access points
- Emergency IP phones

In fact, it's not uncommon for video, voice, and high-rate industrial application data transfers to be integrated onto one network. Moxa's PoE switches are equipped with many advanced PoE management functions, providing vital security systems with a convenient and reliable Ethernet network. Moreover, Moxa's advanced PoE switches support the high power PoE+ standard, a 24 VDC direct power input, and 20 ms fast recovery redundancy with Turbo Ring and Turbo Chain.

## PoE Settings

The PoE settings interface gives users control over the system's PoE power output, PoE power threshold, PoE port configuration, and PD failure check. The PoE settings page is divided into three parts: **PoE System Configuration**, **PoE Port Configuration**, and **PoE Device Failure Check**. Each part is discussed separately below.

**PoE System Configuration**

PoE Power Output

PoE power management mode

PoE system power budget  watts

Note: If a newly connected PD causes the total measured power to exceed the total power budget, the connected PD with the lowest priority will be denied power.

**PoE Port Configuration**

Port	Power	Output Mode	Power Allocation	Legacy PD Detection	Power Priority
G1	<input checked="" type="checkbox"/> Enable	802.3 af/at Auto ▼	0	<input type="checkbox"/>	1
G2	<input checked="" type="checkbox"/> Enable	802.3 af/at Auto ▼	16	<input type="checkbox"/>	2
G3	<input checked="" type="checkbox"/> Enable	802.3 af/at Auto ▼	0	<input type="checkbox"/>	3
G4	<input checked="" type="checkbox"/> Enable	802.3 af/at Auto ▼	0	<input type="checkbox"/>	4
G5	<input checked="" type="checkbox"/> Enable	802.3 af/at Auto ▼	0	<input type="checkbox"/>	5
G6	<input checked="" type="checkbox"/> Enable	802.3 af/at Auto ▼	0	<input type="checkbox"/>	6
G7	<input checked="" type="checkbox"/> Enable	802.3 af/at Auto ▼	0	<input type="checkbox"/>	7
G8	<input checked="" type="checkbox"/> Enable	802.3 af/at Auto ▼	0	<input type="checkbox"/>	8

**PoE Device Failure Check**

Port	Enable	PoE Device Failure Check	No Response Timeout (Cycles 1~10)	Check Period (Seconds 5~300)	No Response Action
G1	<input type="checkbox"/>	IP: <input type="text"/>	3 <input type="text"/>	10 <input type="text"/>	No Action <input type="button" value="v"/>
G2	<input type="checkbox"/>	IP: <input type="text"/>	3 <input type="text"/>	10 <input type="text"/>	No Action <input type="button" value="v"/>
G3	<input type="checkbox"/>	IP: <input type="text"/>	3 <input type="text"/>	10 <input type="text"/>	No Action <input type="button" value="v"/>
G4	<input type="checkbox"/>	IP: <input type="text"/>	3 <input type="text"/>	10 <input type="text"/>	No Action <input type="button" value="v"/>
G5	<input type="checkbox"/>	IP: <input type="text"/>	3 <input type="text"/>	10 <input type="text"/>	No Action <input type="button" value="v"/>
G6	<input type="checkbox"/>	IP: <input type="text"/>	3 <input type="text"/>	10 <input type="text"/>	No Action <input type="button" value="v"/>
G7	<input type="checkbox"/>	IP: <input type="text"/>	3 <input type="text"/>	10 <input type="text"/>	No Action <input type="button" value="v"/>
G8	<input type="checkbox"/>	IP: <input type="text"/>	3 <input type="text"/>	10 <input type="text"/>	No Action <input type="button" value="v"/>

### PoE System Configuration

**NOTE** The configuration is different, depending on whether the “PoE power output managed by” item is set to “Allocated Power” or “Measured Power.”

#### PoE Power Management by Allocated Power

**PoE System Configuration**

PoE Power Output

PoE power management mode

PoE system power budget  Watts

Note: If a newly connected PD causes the total allocated power to exceed the total power budget, the newly connected PD will be denied power.

#### PoE Power Management by Measured Power

**PoE System Configuration**

PoE Power Output

PoE power management mode

PoE system power budget  Watts

Note: If a newly connected PD causes the total allocated power to exceed the total power budget, the newly connected PD will be denied power.

## PoE System Configuration Settings

### PoE Power Output

Setting	Description	Factory Default
Enable	Enables PoE power transmission to a PD	Enable
Disable	Disables PoE power transmission to a PD	

### PoE power management Mode

Setting	Description	Factory Default
Allocated Power	If a powered device is connected that would cause the total amount of power needed by all connected devices to exceed the total allocated power limit, the switch will not power up the device.	Disable
Measured Power	If a powered device is connected that would cause the total amount of power needed by all connected devices to exceed the total measured power limit, the switch with will deny power to the device with the lowest priority.	Enable

### Deny next port when exceed

This setting only appears when "PoE power output management mode" is set to "Allocated Power."

Setting	Description	Factory Default
wattage	Assigns the "Total allocated power" limit for all PoE ports combined.	720 W

### Deny low priority port when exceed

This setting only appears when "PoE power output managed by" is set to "Measured Power."

Setting	Description	Factory Default
wattage	Assigns the "Total measured power" limit for all PoE ports combined.	720 W

## PoE Port Configuration

PoE Port Configuration					
Port	Power	Output Mode	Power Allocation	Legacy PD Detection	Power Priority
G1	<input checked="" type="checkbox"/> Enable	802.3 af/at Auto ▼	0	<input type="checkbox"/>	1
G2	<input checked="" type="checkbox"/> Enable	802.3 af/at Auto ▼	0	<input type="checkbox"/>	2
G3	<input checked="" type="checkbox"/> Enable	802.3 af/at Auto ▼	30	<input type="checkbox"/>	3
G4	<input checked="" type="checkbox"/> Enable	802.3 af/at Auto ▼	0	<input type="checkbox"/>	4
G5	<input checked="" type="checkbox"/> Enable	802.3 af/at Auto ▼	30	<input type="checkbox"/>	5
G6	<input checked="" type="checkbox"/> Enable	802.3 af/at Auto ▼	0	<input type="checkbox"/>	6
G7	<input checked="" type="checkbox"/> Enable	802.3 af/at Auto ▼	0	<input type="checkbox"/>	7
G8	<input checked="" type="checkbox"/> Enable	802.3 af/at Auto ▼	0	<input type="checkbox"/>	8

### Power

Setting	Description	Factory Default
Checked	Allows data and power to be transmitted through the port.	Checked
Unchecked	Immediately shuts off power to that port	

**Output Mode**

Setting	Description	Factory Default
802.3 af/at Auto	Power transmission follows the IEEE 802.3 af/at protocols. The acceptable PD resistance range is 17 kΩ to 29 kΩ.	802.3 af/at Auto
High Power	Provides a higher power output to the PD. The acceptable PD resistance range is 17 kΩ to 29 kΩ, and the power allocation of the port is automatically set to 36 W.	
Force	Provides power output to non-802.3 af/at PDs. The acceptable PD resistance range is over 2.4 kΩ, and the range of power allocation is 0 to 36 W.	

**Power Allocation**

Setting	Description	Factory Default
0 to 36	When the Output Mode is set to <b>Force</b> , the Power Allocation can be set from 0 to 36 W.	36

**Legacy PD Detection**

The PoE Ethernet Switch provides a **Legacy PD Detection** function. When the capacitance of the PD is higher than 2.7 μF, checking the **Legacy PD Detection** checkbox enables the system to output power to the PD. In this case, it will take 10 to 15 seconds for PoE power to be output through this port after the switch is turned on.

Setting	Description	Factory Default
Checked	Enables legacy PD detection	Unchecked
Unchecked	Disables legacy PD detection	

**Power Priority**

Use **Power Priority** when managing PoE power with measured power mode. The smaller the number, the higher the priority. You may set the same priority for different PoE ports, but if you configure two ports with the same priority, then the port with the lower port number has the higher priority. The setting can range from 1 up to the total number of ports. When the PoE measured power exceeds the assigned limit, the switch will disable the PoE port with the lowest priority.

Setting	Description	Factory Default
1 to "number of PoE ports"	The smaller the number, the higher the PoE port priority. When the PoE measured power exceeds the assigned limit, the switch will disable the PoE port with the lowest priority.	The PoE port index number

## PoE Device Failure Check

The PoE Ethernet switch can monitor the status of a PD via its IP address. If the PD fails, the switch will not receive a PD response after the defined period, and the authentication process will be restarted. This function is extremely useful for ensuring your network's reliability and reducing your management burden.

**PoE Device Failure Check**

Port	Enable	PoE Device Failure Check	No Response Timeout (Cycles 1~10)	Check Period (Seconds 5~300)	No Response Action
G1	<input type="checkbox"/>	IP: <input type="text"/>	<input type="text" value="3"/>	<input type="text" value="10"/>	No Action ▼
G2	<input type="checkbox"/>	IP: <input type="text"/>	<input type="text" value="3"/>	<input type="text" value="10"/>	No Action ▼
G3	<input type="checkbox"/>	IP: <input type="text"/>	<input type="text" value="3"/>	<input type="text" value="10"/>	No Action ▼
G4	<input type="checkbox"/>	IP: <input type="text"/>	<input type="text" value="3"/>	<input type="text" value="10"/>	No Action ▼
G5	<input type="checkbox"/>	IP: <input type="text"/>	<input type="text" value="3"/>	<input type="text" value="10"/>	No Action ▼
G6	<input type="checkbox"/>	IP: <input type="text"/>	<input type="text" value="3"/>	<input type="text" value="10"/>	No Action ▼
G7	<input type="checkbox"/>	IP: <input type="text"/>	<input type="text" value="3"/>	<input type="text" value="10"/>	No Action ▼
G8	<input type="checkbox"/>	IP: <input type="text"/>	<input type="text" value="3"/>	<input type="text" value="10"/>	No Action ▼

**Apply**

### Enable

Setting	Description	Factory Default
Checked	Enables the PD Failure Check function	Unchecked
Unchecked	Disables the PD Failure Check function	

### PoE Device IP Address

Setting	Description	Factory Default
Max. 15 Characters	Enter the PD's IP address	None

### No Response Timeout

Setting	Description	Factory Default
1 to 10	The maximum number of IP checking cycles.	3

### Check Period

Setting	Description	Factory Default
5 to 300	Enter maximum time allowed for each IP checking cycle.	10

### No Response Action

Setting	Description	Factory Default
No Action	The PSE has no action on the PD	No Action
Reboot PD	The PSE reboots the PD after the PD Failure Check	
Power Off PD	The PSE powers off the PD after the PD Failure Check	

## PoE Timetabling

Powered devices usually do not need to be running 24 hours a day, 7 days a week. The PoE Ethernet switch provides a PoE timetabling mechanism that lets users economize the system's power burden by setting a flexible working schedule for each PoE port.

### Port

Setting	Description	Factory Default
Port	Select which port you would like to configure.	The first port of the first PoE module

### Enable

Setting	Description	Factory Default
Checked	Enables the PoE function of the port for the defined time period.	Unchecked
Unchecked	Enables the PoE function of the port all the time.	

### MON, TUE, WED, THU, FRI, SAT, SUN

Setting	Description	Factory Default
Checked	Select those days on which you would like the port to be enabled (you will then be able to modify the StartTime and EndTime)	Disable
Unchecked	The port will not provide PoE power on days that are not check marked.	

### Start/End Time

Setting	Description	Factory Default
Configured time period	Enter the hour of the day the configuration will be enabled, and the hour of the day the configuration will be disabled.	0 to 24



## PoE Warning Event Settings

Since industrial Ethernet devices are often located at the endpoints of a system, these devices do not always know what is happening elsewhere on the network. This means that a PoE port connected to a PD must provide system administrators with real-time alarm messages. Even when control engineers are out of the control room for an extended period of time, they can still be informed of the status of the PD almost instantaneously when exceptions occur. The PoE Ethernet switch supports different methods for warning engineers automatically, including SNMP trap, email, and relay output. It also supports two digital inputs to integrate sensors into your system to automate alarms using email and relay output. The PoE warning event settings are on the **System Event Settings** page.

### System Event Settings

<input type="checkbox"/>	Event	Action					Severity
		Trap	E-Mail	Syslog	Relay1	Relay2	
<input checked="" type="checkbox"/>	PoE PD On	<input checked="" type="checkbox"/>	<input type="checkbox"/>	<input checked="" type="checkbox"/>	<input type="checkbox"/>	<input type="checkbox"/>	Warning <span style="font-size: small;">▼</span>
<input checked="" type="checkbox"/>	PoE PD Off	<input checked="" type="checkbox"/>	<input type="checkbox"/>	<input checked="" type="checkbox"/>	<input type="checkbox"/>	<input type="checkbox"/>	Warning <span style="font-size: small;">▼</span>
<input checked="" type="checkbox"/>	Over Measured Power limitation	<input checked="" type="checkbox"/>	<input type="checkbox"/>	<input checked="" type="checkbox"/>	<input type="checkbox"/>	<input type="checkbox"/>	Warning <span style="font-size: small;">▼</span>
<input checked="" type="checkbox"/>	PoE FETBad	<input checked="" type="checkbox"/>	<input type="checkbox"/>	<input checked="" type="checkbox"/>	<input type="checkbox"/>	<input type="checkbox"/>	Warning <span style="font-size: small;">▼</span>
<input checked="" type="checkbox"/>	PoE Over Temperature	<input checked="" type="checkbox"/>	<input type="checkbox"/>	<input checked="" type="checkbox"/>	<input type="checkbox"/>	<input type="checkbox"/>	Warning <span style="font-size: small;">▼</span>
<input checked="" type="checkbox"/>	PoE VEE Uvlo	<input checked="" type="checkbox"/>	<input type="checkbox"/>	<input checked="" type="checkbox"/>	<input type="checkbox"/>	<input type="checkbox"/>	Warning <span style="font-size: small;">▼</span>
<input checked="" type="checkbox"/>	PoE PD Over Current	<input checked="" type="checkbox"/>	<input type="checkbox"/>	<input checked="" type="checkbox"/>	<input type="checkbox"/>	<input type="checkbox"/>	Warning <span style="font-size: small;">▼</span>
<input checked="" type="checkbox"/>	PoE PD Check Fail	<input checked="" type="checkbox"/>	<input type="checkbox"/>	<input checked="" type="checkbox"/>	<input type="checkbox"/>	<input type="checkbox"/>	Warning <span style="font-size: small;">▼</span>
<input checked="" type="checkbox"/>	Over Allocated Power limitation	<input checked="" type="checkbox"/>	<input type="checkbox"/>	<input checked="" type="checkbox"/>	<input type="checkbox"/>	<input type="checkbox"/>	Warning <span style="font-size: small;">▼</span>
<input checked="" type="checkbox"/>	Login Failure Lockout	<input type="checkbox"/>	<input type="checkbox"/>	<input checked="" type="checkbox"/>	<input type="checkbox"/>	<input type="checkbox"/>	Warning <span style="font-size: small;">▼</span>
<input checked="" type="checkbox"/>	Account Info Changed	<input checked="" type="checkbox"/>	<input type="checkbox"/>	<input checked="" type="checkbox"/>	<input type="checkbox"/>	<input type="checkbox"/>	Warning <span style="font-size: small;">▼</span>

Apply

### Warning Type

Action	Description
Trap	A notification will be sent to the trap server when an event is triggered.
E-Mail	A notification will be sent to the email server defined in Email Settings.
Syslog	Record a syslog to a syslog server defined in Syslog Server Settings.
Relay1/2	Supports digital inputs to integrate sensors. When an event is triggered, the device will automatically activate an alarm through the relay output.

### Event Type

Port Events	Description
PoE PD on	Power is being output to the PD.
PoE PD off	The PoE power output is cut off.
PoE over current	When the current of the port exceeds the following limits: 802.3 af:        350 mA 802.3 at:        600 mA High Power:    720 mA Force:           600 mA
PoE PD Failure Check	When the switch does not receive a PD response after the defined period.

Port Events	Description
Over Measured Power Limitation	When the total PD power consumption exceeds the total measured power limit.
PoE FETBad	When the MOSFET of the port is out of order (please contact Moxa for technical service)
PoE over Temperature	Check the temperature of the environment. If you cannot keep the temperature under 75°C, contact Moxa for technical support.
PoE VEE Uvlo - VEE (PoE input voltage) under Voltage Lockout	The voltage of the power supply has dropped below 44 VDC. Adjust the voltage to between 46 and 57 VDC to eliminate this issue.
Over Allocated Power Limitation	When the total PD power consumption exceeds the total allocated power.

## PoE Diagnose

### PoE Diagnostics

Port	Device Type	Classification	Voltage(V)	PoE Port Configuration Suggestion
G1	NIC	N/A	N/A	Disable PoE power output
G2	IEEE 802.3af	N/A	N/A	Select IEEE 802.3 af/at auto mode
G3	Not Present	N/A	N/A	
G4	Not Present	N/A	N/A	
G5	Not Present	N/A	N/A	
G6	Not Present	N/A	N/A	
G7	Not Present	N/A	N/A	
G8	NIC	N/A	N/A	Disable PoE power output

Refresh

**PoE Diagnose** helps users determine the PD conditions. The system provides the user with configuration options; select the best option for your PDs. Take the following steps to diagnose PD conditions:

- Step 1:** Check which port numbers will be diagnosed.
- Step 2:** Click **Activate**.
- Step 3:** The system will show the selected PD conditions.

### Diagnose Configuration

#### Device Type

Item	Description
Not Present	No connection to the port
NIC	A NIC is connected to the port
IEEE 802.3af	An IEEE 802.3af PD is connected to the port
IEEE 802.3 at	An IEEE 802.3at PD is connected to the port
Legacy PoE Device	A legacy PD is connected to the port, and the PD's detected voltage is too high or low, or the PD's detected capacitance is too high.
Unknown	Unknown PD connected to the port

#### Classification

Item	Description
N/A	The port is not classified
0 to 4	Class 0 to 4
Unknown	Unknown class for the port; in this case it will usually be higher than class 4

**Voltage (V)**

Item	Description
N/A	No voltage output on the port
Voltage	Display the voltage of the port

**PoE Port Configuration Suggestion**

Item	Description
Disable PoE power output	When detecting a NIC or unknown PD, the system suggests disabling PoE power output.
Enable "Legacy PD Detection"	When detecting a higher capacitance of PD, the system suggests enabling Legacy PD Detection.
Select Force Mode	When detecting higher/lower resistance or higher capacitance, the system suggests selecting Force Mode.
Select IEEE 802.3af/at auto mode	When detecting an IEEE 802.3 af/at PD, the system suggests selecting 802.3 af/at Auto mode.
Select high power output	When detecting an unknown classification, the system suggests selecting High Power output.
Raise the external power supply voltage to greater than 46 VDC	When the external supply voltage is detected at under 46 V, the system suggests raising the voltage.
Enable PoE function for detection	The system suggests enabling the PoE function.

**PoE Port Status**

### PoE Port Status

**Monitoring Configuration**

Refresh Rate:  seconds (5~300 seconds)

**PSE Status**

V<sub>EE</sub> Voltage:  Volts

**Port Status**

G1 ● G2 ○ G3 ○ G4 ○ G5 ○ G6 ○ G7 ○ G8 ●

Status Description

<span style="color: gray;">○</span> Not Present	<span style="color: gray;">●</span> Disabled	<span style="color: orange;">○</span> Potential Legacy PD
<span style="color: green;">●</span> Powered	<span style="color: red;">●</span> Fault	
<span style="color: purple;">●</span> NIC	<span style="color: pink;">●</span> Legacy Powered	





Port	Status	Power Output	Class	Current(mA)	Voltage (V)	Consumption (Watts)	PD Failure Check Status
G1	Enable	OFF	N/A	N/A	N/A	N/A	Disabled
G2	Enable	OFF	N/A	N/A	N/A	N/A	Disabled
G3	Enable	OFF	N/A	N/A	N/A	N/A	Disabled
G4	Enable	OFF	N/A	N/A	N/A	N/A	Disabled
G5	Enable	OFF	N/A	N/A	N/A	N/A	Disabled
G6	Enable	OFF	N/A	N/A	N/A	N/A	Disabled
G7	Enable	OFF	N/A	N/A	N/A	N/A	Disabled
G8	Enable	OFF	N/A	N/A	N/A	N/A	Disabled

## Monitoring Configuration

### Refresh Rate

Setting	Description	Factory Default
5 to 300	The period of time for the system to refresh the PoE Port Status (in seconds)	5

### Port Status

Status Description		
 Not Present	 Disabled	 Potential Legacy PD
 Powered	 Fault	
 NIC	 Legacy Powered	

### Status Description

Item	Description
Not Present	No connection to the port. PoE power is not being provided.
Powered	PoE power is being provided by the PSE.
NIC	System has detected a NIC connected to the port. PoE power is not being provided.
Disabled	The PoE function of the port is disabled. PoE power is not being provided.
Fault	In Force mode; the system has detected an out-of-range PD.
Legacy Powered	In Force mode; the system has detected a legacy PD.
Potential Legacy PD	In 802.3af/at or High Power mode; the system has detected a potential legacy PD. PoE power is not being provided.

### Port Description

Item	Description
Status	Indicates if the PoE function is enabled or disabled.
Power Output	Indicates the power output of each PoE port.
Class	Indicates the classification of each PoE port.
Current (mA)	Indicates the actual current consumed by each PoE port.
Voltage (V)	Indicates the actual voltage consumed by each PoE port.
Consumption (Watts)	Indicates the actual Power consumed by each PoE port.
PD Failure Check Status	Indicates the PD Failure Check status of each PoE port. Alive: The system receives a response from all pings to the PD. Not Alive: The system receives no response from pings to the PD. Disabled: The PD Failure Check function is not activated.

## PoE System Status

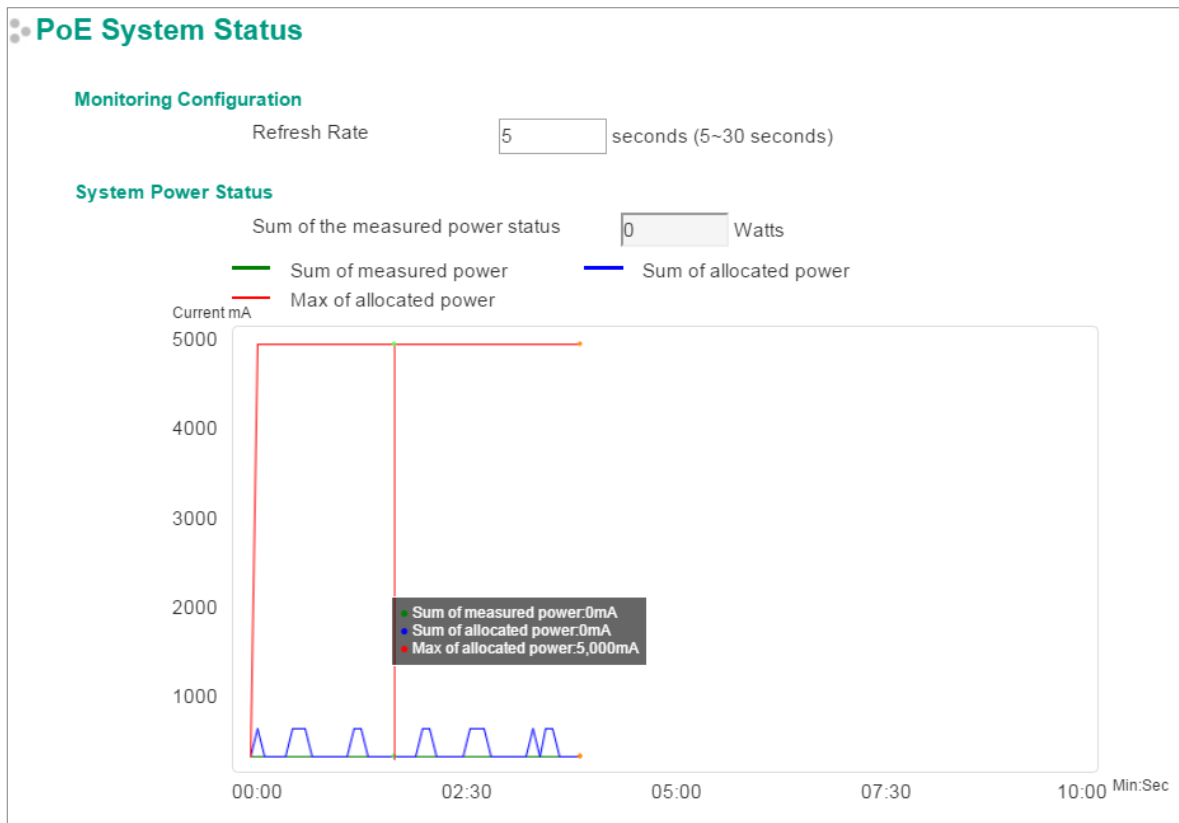

### Monitoring Configuration

#### Refresh Rate

Setting	Description	Factory Default
5 to 300	If the Refresh Rate = T, then the PoE Port Status will be refreshed every T seconds.	5

### System Power Status

System Power Status shows a graph of **Sum of measured power**, **Sum of allocated power**, and **Max of allocated power**. “Sum of measured power” (in green) shows the total measured power of all PDs, “Sum of allocated power” (in blue) shows the total allocated power, and “Max of allocated power” (in red) shows the threshold of total PoE power output. The graphs show **Current (mA)** versus **Sec. (second)**, and are refreshed at the configured Refresh Rate.

Patent [http://www.moxa.com/doc/operations/Moxa\\_Patent\\_Marking.pdf](http://www.moxa.com/doc/operations/Moxa_Patent_Marking.pdf)

# VLAN

Setting up Virtual LANs (VLANs) on your Moxa switch increases the efficiency of your network by dividing the LAN into logical segments, as opposed to physical segments. In general, VLANs are easier to manage.

## The Virtual LAN (VLAN) Concept

### What is a VLAN?

A VLAN is a group of devices that can be located anywhere on a network, but which communicate as if they are on the same physical segment. With VLANs, you can segment your network without being restricted by physical connections—a limitation of traditional network design. With VLANs you can segment your network into:

- **Departmental groups**—You could have one VLAN for the marketing department, another for the finance department, and another for the product development department.
- **Hierarchical groups**—You could have one VLAN for directors, another for managers, and another for general staff.
- **Usage groups**—You could have one VLAN for email users and another for multimedia users.

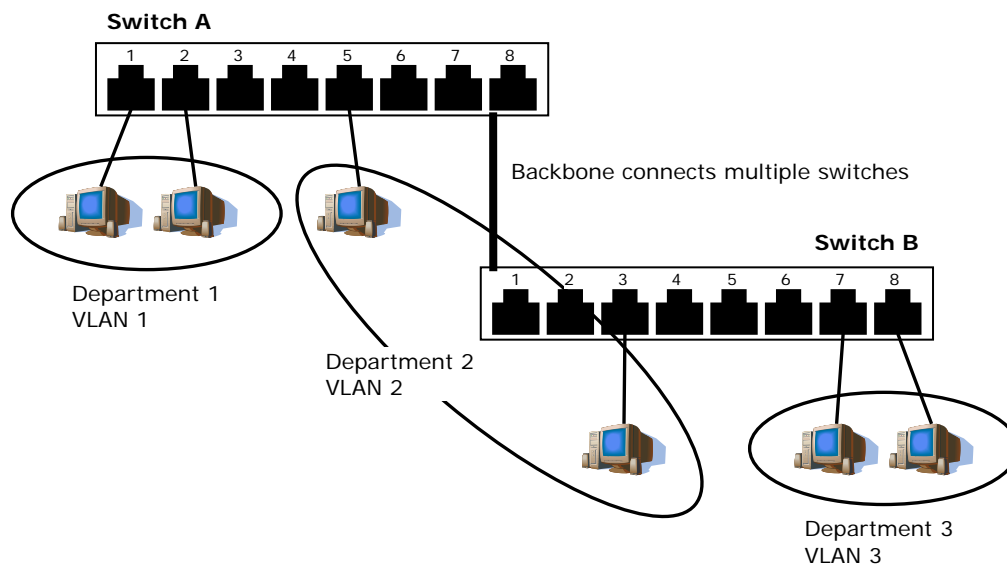

### Benefits of VLANs

The main benefit of VLANs is that they provide a network segmentation system that is far more flexible than traditional networks. Using VLANs also provides you with three other benefits:

- **VLANs ease the relocation of devices on networks:** With traditional networks, network administrators spend much of their time dealing with moves and changes. If users move to a different subnetwork, the addresses of each host must be updated manually. With a VLAN setup, if a host originally on the Marketing VLAN, is moved to a port on another part of the network, and retains its original subnet membership, you only need to specify that the new port is on the Marketing VLAN. You do not need to do any re-cabling.
- **VLANs provide extra security:** Devices within each VLAN can only communicate with other devices on the same VLAN. If a device on the Marketing VLAN needs to communicate with devices on the Finance VLAN, the traffic must pass through a routing device or Layer 3 switch.
- **VLANs help control traffic:** With traditional networks, congestion can be caused by broadcast traffic that is directed to all network devices, regardless of whether or not they need it. VLANs increase the efficiency of your network because each VLAN can be set up to contain only those devices that need to communicate with each other.

## VLANs and the Rackmount switch

Your Moxa switch provides support for VLANs using IEEE Std 802.1Q-1998. This standard allows traffic from multiple VLANs to be carried across one physical link. The IEEE Std 802.1Q-1998 standard allows each port on your Moxa switch to be placed as follows:

- On a single VLAN defined in the Moxa switch
- On several VLANs simultaneously using 802.1Q tagging

The standard requires that you define the *802.1Q VLAN ID* for each VLAN on your Moxa switch before the switch can use it to forward traffic:

## Managing a VLAN

A new or initialized Moxa switch contains a single VLAN—the Default VLAN. This VLAN has the following definition:

- *VLAN Name*—Management VLAN
- *802.1Q VLAN ID*—1 (if tagging is required)

All the ports are initially placed on this VLAN, and it is the only VLAN that allows you to access the management software of the Moxa switch over the network.

## Communication Between VLANs

If devices connected to a VLAN need to communicate with devices on a different VLAN, a router or Layer 3 switching device with connections to both VLANs needs to be installed. Communication between VLANs can only take place if they are all connected to a routing or Layer 3 switching device.

## VLANs: Tagged and Untagged Membership

The Moxa switch supports 802.1Q VLAN tagging, a system that allows traffic for multiple VLANs to be carried on a single physical link (backbone, trunk). When setting up VLANs you need to understand when to use untagged or tagged membership of VLANs. Simply put, if a port is on a single VLAN it can be an untagged member, but if the port needs to be a member of multiple VLANs, a tagged membership must be defined.

A typical host (e.g., clients) will be an untagged member of one VLAN, defined as an **Access Port** in a Moxa switch, while an inter-switch connection will be a tagged member of all VLANs, defined as a **Trunk Port** in a Moxa switch.

The IEEE Std 802.1Q-1998 defines how VLANs operate within an open packet-switched network. An 802.1Q compliant packet carries additional information that allows a switch to determine which VLAN the port belongs to. If a frame is carrying the additional information, it is known as a *tagged* frame.

To carry multiple VLANs across a single physical link (backbone, trunk), each packet must be tagged with a VLAN identifier so that the switches can identify which packets belong in which VLAN. To communicate between VLANs, a router must be used.

The Moxa switch supports three types of VLAN port settings:

- **Access Port:** The port connects to a single device that is not tagged. The user must define the default port PVID that assigns which VLAN the device belongs to. Once the ingress packet of this Access Port egresses to another Trunk Port (the port needs all packets to carry tag information), the Moxa switch will insert this PVID into this packet so the next 802.1Q VLAN switch can recognize it.
- **Trunk Port:** The port connects to a LAN that consists of untagged devices, tagged devices, and/or switches and hubs. In general, the traffic of the Trunk Port must have a Tag. Users can also assign a PVID to a Trunk Port. The untagged packet on the Trunk Port will be assigned the default port PVID as its VID.
- **Hybrid Port:** The port is similar to a Trunk port, except users can explicitly assign tags to be removed from egress packets.

The following section illustrates how to use these ports to set up different applications.

## Sample Applications of VLANs Using Moxa Switches

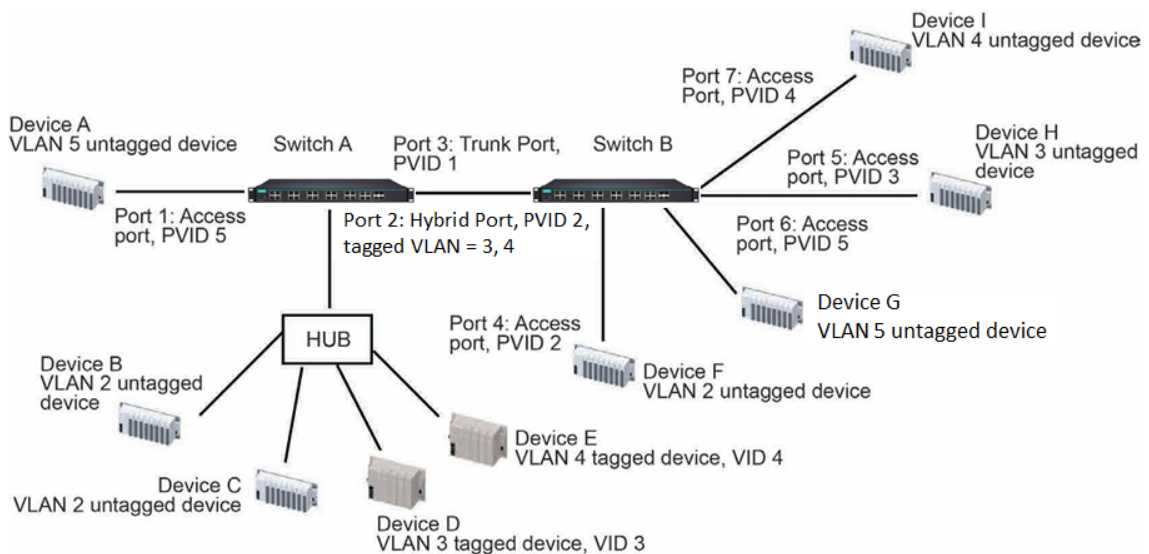

In this application:

- Port 1 connects a single untagged device and assigns it to VLAN 5; it should be configured as an **Access Port** with PVID 5.
- Port 2 connects a LAN with two untagged devices belonging to VLAN 2. One tagged device with VID 3 and one tagged device with VID 4. It should be configured as a **Hybrid Port** with PVID 2 for untagged device and Fixed VLAN (Tagged) with 3 and 4 for tagged device. Since each port can only have one unique PVID, all untagged devices on the same port must belong to the same VLAN.
- Port 3 connects with another switch. It should be configured as a **Trunk Port**. GVRP protocol will be used through the Trunk Port.
- Port 4 connects a single untagged device and assigns it to VLAN 2; it should be configured as an **Access Port** with PVID 2.
- Port 5 connects a single untagged device and assigns it to VLAN 3; it should be configured as an **Access Port** with PVID 3.
- Port 6 connect a single untagged device and assigns it to VLAN 5; it should be configured as an **Access Port** with PVID 5.
- Port 7 connects a single untagged device and assigns it to VLAN 4; it should be configured as an **Access Port** with PVID 4.

After the application is properly configured:

- Packets from Device A will travel through **Trunk Port 3** with tagged VID 5. Switch B will recognize its VLAN, pass it to port 6, and then remove tags received successfully by Device G, and vice versa.
- Packets from Devices B and C will travel through **Hybrid Port 2** with tagged VID 2. Switch B recognizes its VLAN, passes it to port 4, and then removes tags received successfully by Device F, and vice versa.
- Packets from Device D will travel through **Trunk Port 3** with tagged VID 3. Switch B will recognize its VLAN, pass to port 5, and then remove tags received successfully by Device H. Packets from Device H will travel through **Trunk Port 3** with PVID 3. Switch A will recognize its VLAN and pass it to port 2, but will not remove tags received successfully by Device D.
- Packets from Device E will travel through **Trunk Port 3** with tagged VID 4. Switch B will recognize its VLAN, pass it to port 7, and then remove tags received successfully by Device I. Packets from Device I will travel through **Trunk Port 3** with tagged VID 4. Switch A will recognize its VLAN and pass it to port 2, but will not remove tags received successfully by Device E.



## Configuring a Virtual LAN

To configure 802.1Q VLAN and port-based VLANs on the Moxa switch, use the **VLAN Settings** page to configure the ports for either an **802.1Q VLAN** or **Port-based VLAN**.

### VLAN Mode

Setting	Description	Factory Default
802.1Q VLAN	Sets VLAN mode to 802.1Q VLAN	802.1Q VLAN
Port-based VLAN	Sets VLAN mode to Port-based VLAN	

## VLAN Settings: 802.1Q

### VLAN Settings

VLAN Mode 802.1Q VLAN

**Quick Setting Panel**

Port	Type	PVID	Tagged VLAN	Untagged VLAN	Forbidden VLAN
G1,G4	Trunk	1	3		

**Add**

Note: Use port description such as "6", "G6", "1-6"  
Note: 5,6,G1:G3 means the configuration will be copied to port 5,6,G1,G2,G3

**VLAN ID Configuration Table**

Enable GVRP

Management VLAN ID 1

Port	Type	PVID	Tagged VLAN	Untagged VLAN	Forbidden VLAN
G1	Trunk	1	3		
G2	Trunk	1	2		
G3	Trunk	1	2		
G4	Trunk	1	3		

When VLAN Mode is set to 802.1Q VLAN, the configuration options will be divided into the **Quick Setting Panel** and **VLAN ID Configuration Table**. The Quick Setting Panel is generally used to configure VLAN settings for groups of ports, with the settings pushed down to the VLAN ID Configuration Panel when the user clicks the Add button. The VLAN ID Configuration Table can be used to configure the settings for individual ports.

### Quick Setting Panel

Administrators can use the **Quick Setting Panel** to quickly configure VLAN settings for single ports or groups of ports. To configure a group of ports, type the port names in the **Port** column, separated commas (,) for individual port names, or colons (:) to indicate a range of ports. For example, typing "G1,G3" applies the settings to ports G1 and G3, whereas typing "G1:G3" applies the settings to ports G1, G2, and G3. Next, if necessary configure **Type**, **PVID**, **Tagged VLAN**, **Untagged VLAN**, and **Forbidden VLAN**, and then click the **Add** button to move the settings down to the table at the bottom of the window.

### VLAN ID Configuration Table

#### Enable GVRP

Setting	Description	Factory Default
Checked/Unchecked	Check the checkbox to enable the GVRP function. Remove the checkmark to disable the GVRP function.	Checked

**Management VLAN ID**

Setting	Description	Factory Default
1 to 4094	Assigns the VLAN ID to this Moxa switch.	1

**NOTE** Some of the following settings can be modified in the Quick Setting Panel.

**Port**

Setting	Description	Factory Default
Port name	Read only	N/A

**Type**

Setting	Description	Factory Default
Access	When this port is connected to a single device, without tags.	Access
Trunk	When this port is connected to another 802.1Q VLAN aware switch.	
Hybrid	When this port is connected to another Access 802.1Q VLAN aware switch or another LAN that combines tagged and/or untagged devices and/or other switches/hubs.	

**ATTENTION**

For communication redundancy in the VLAN environment, set **Redundant Port Coupling Ports** and **Coupling Control Ports** to **Trunk Port**, since these ports act as the **backbone** for transmitting packets from different VLANs to different Moxa switch units.

**PVID**

Setting	Description	Factory Default
1 to 4094	Sets the default VLAN ID for untagged devices connected to the port.	1

**Tagged VLAN**

Setting	Description	Factory Default
1 to 4094	This field will be active only when selecting the Trunk or Hybrid port type. Set the other VLAN ID for tagged devices that connect to the port. Use commas to separate different VLANs.	None

**Untagged VLAN**

Setting	Description	Factory Default
VID range from 1 to 4094	This field is only active when the Hybrid port type is selected. Set the other VLAN ID for tagged devices that connect to the port and tags that need to be removed in egress packets. Use commas to separate different VLANs.	None

**Forbidden VLAN**

Setting	Description	Factory Default
1 to 4094	This field is only active when Trunk or Hybrid port type is selected. Set the other VLAN IDs that will not be supported by this port. Use commas to separate different VLANs.	None

**NOTE** The **Quick Setting Panel** provides a quick way of configuring multiple VLAN ports with the same setting.

## VLAN Name Setting

For the 802.1Q VLAN, the user is able to set VLAN name of each VLAN ID (VID).

### VLAN Name Setting

VID	Name
1	<input style="width: 95%;" type="text"/>

### VLAN Name Setting

Setting	Description	Factory Default
Name	The VLAN name can only include these characters, a-z/A-Z/0-9/-/_/	Null

## QinQ Settings

**NOTE** Moxa's layer 3 switches support the IEEE 802.1ad QinQ function, which allows users to tag double VLAN headers into a single Ethernet frame.

### QinQ Settings

TPID  (8100-FFFF, hexadecimal value)

Port	QinQ Enable
1-1	<input type="checkbox"/>
1-2	<input type="checkbox"/>
1-3	<input type="checkbox"/>
1-4	<input type="checkbox"/>

### TPID

Setting	Description	Factory Default
8100 to FFFF	Assign the TPID of the second VLAN tag	8100

### QinQ Enable

Setting	Description	Factory Default
Enable/Disable	Enable VLAN QinQ function	Disable

## VLAN Table

### VLAN Table

VLAN Mode                    802.1Q VLAN  
 Management VLAN         1

Index	VID	Name	Joined Access Port	Joined Trunk Port	Joined Hybrid Port
1	1		1, 2, 3, 4, 5, 6, 7, 8, 9, 10, 11, 12, 13, 14, G1, G2, G3, G4,		

VLAN Table		
VLAN Mode		Port-based VLAN
Index	VLAN	Joined Port
1	1	1, 2, 3, 4, 5, 6, 7, 8, 9, 10, 11, 12, 13, 14, G1, G2, G3, G4,

Use the **802.1Q VLAN table** to review the VLAN groups that were created, VLAN Name, **Joined Access Ports, Trunk Ports, and Hybrid Ports**, and use the **Port-based VLAN table** to review the **VLAN groups and Joined Ports**.

# Port

## Port Settings

Port settings are included to give the user control over port access, port transmission speed, flow control, and port type (MDI or MDIX).

Port Settings							
Port	Enable	Media Type	Description	Speed	Flow Ctrl	MDI/MDIX	TID
1	<input checked="" type="checkbox"/>	1000FX,miniGBIC,PTP	<input type="text"/>	1G-Full	Disable	Auto	N/A
2	<input checked="" type="checkbox"/>	1000FX,miniGBIC,PTP	<input type="text"/>	1G-Full	Disable	Auto	N/A
3	<input checked="" type="checkbox"/>	1000TX,RJ45,PTP	<input type="text"/>	Auto	Disable	Auto	N/A
4	<input checked="" type="checkbox"/>	1000TX,RJ45,PTP	<input type="text"/>	Auto	Disable	Auto	N/A
1-1	<input checked="" type="checkbox"/>	1000TX,RJ45,PTP.	<input type="text"/>	Auto	Disable	Auto	N/A
1-2	<input checked="" type="checkbox"/>	1000TX,RJ45,PTP.	<input type="text"/>	Auto	Disable	Auto	N/A
1-3	<input checked="" type="checkbox"/>	1000TX,RJ45,PTP.	<input type="text"/>	Auto	Disable	Auto	N/A

**Apply**

**Enable**

Setting	Description	Factory Default
Checked	Allows data transmission through the port.	Checked
Unchecked	Immediately shuts off port access.	

**Media Type**

Setting	Description	Factory Default
Media type	Displays the media type for each module's port	N/A

**Description**

Setting	Description	Factory Default
Max. 63 characters	Specifies an alias for the port to help administrators differentiate between different ports. Example: PLC 1	None

**Speed**

Setting	Description	Factory Default
Auto	Allows the port to use the IEEE 802.3u protocol to negotiate with connected devices. The port and connected devices will determine the best speed for that connection.	Auto
100M-Full	Choose one of these fixed speed options if the connected Ethernet device has trouble auto-negotiating for line speed.	
100M-Half		
10M-Full		
10M-Half		

**FDX Flow Ctrl**

This setting enables or disables flow control for the port when the port’s Speed is set to Auto. The final result will be determined by the Auto process between the Moxa switch and connected devices.

Setting	Description	Factory Default
Enable	Enables flow control for this port when the port’s Speed is set to Auto.	Disabled
Disable	Disables flow control for this port when the port’s Speed is set to Auto.	

**MDI/MDIX**

Setting	Description	Factory Default
Auto	Allows the port to auto-detect the port type of the connected Ethernet device and change the port type accordingly.	Auto
MDI	Choose MDI or MDIX if the connected Ethernet device has trouble auto-negotiating for port type.	
MDIX		

**NOTE** For the Gigabit ports, MDI/MDIX is only Auto mode.

## Port Status

The following table shows the status of each port, including the media type, link status, flow control, and port state.

Port Status					
Port	Media Type	Link Status	MDI/MDIX Status	Flow Control	Port State
1	100TX,RJ45.	Link Down	--	Disabled	--
2	100TX,RJ45.	Link Down	--	Disabled	--
3	100TX,RJ45.	Link Down	--	Disabled	--
4	100TX,RJ45.	Link Down	--	Disabled	--
5	100TX,RJ45.	Link Down	--	Disabled	--
6	100TX,RJ45.	Link Down	--	Disabled	--
7	100TX,RJ45.	Link Down	--	Disabled	--
G1	1000TX,RJ45.	100M Full	MDIX	Disabled	Forwarding
G2	1000TX,RJ45.	Link Down	--	Disabled	--
G3	1000TX,RJ45.	Link Down	--	Disabled	--

## Link Aggregation

Link aggregation involves grouping links into a link aggregation group. A MAC client can treat link aggregation groups as if they were a single link.

The Moxa switch's port trunking feature allows devices to communicate by aggregating up to 4 trunk groups, with a maximum of 8 ports for each group. If one of the 8 ports fails, the other seven ports will automatically provide backup and share the traffic.

Port trunking can be used to combine up to 8 ports between two Moxa switches. If all ports on both switches are configured as 100BaseTX and they are operating in full duplex, the potential bandwidth of the connection will be 1600 Mbps.

## The Port Trunking Concept

Moxa has developed a port trunking protocol that provides the following benefits:

- Greater flexibility in setting up your network connections, since the bandwidth of a link can be doubled, tripled, or quadrupled.
- Redundancy—if one link is broken, the remaining trunked ports share the traffic within this trunk group.
- Load sharing—MAC client traffic can be distributed across multiple links.

To avoid broadcast storms or loops in your network while configuring a trunk, first disable or disconnect all ports that you want to add to the trunk or remove from the trunk. After you finish configuring the trunk, enable or re-connect the ports.

If all ports on both switch units are configured as 100BaseTX and they are operating in full duplex mode, the potential bandwidth of the connection will be up to 1.6 Gbps. This means that users can double, triple, or quadruple the bandwidth of the connection by port trunking between two Moxa switches.

Each Moxa switch can set a maximum of 3 port trunking groups. When you activate port trunking, certain settings on each port will be reset to factory default values or disabled:

- Communication redundancy will be reset.
- 802.1Q VLAN will be reset.
- Multicast Filtering will be reset.
- Port Lock will be reset and disabled.
- Set Device IP will be reset.
- Mirror will be reset.

After port trunking has been activated, you can configure these items again for each trunking port.

## Port Trunking

The **Port Trunking Settings** page is where ports are assigned to a trunk group.

Select	Port	Media Type	Description	Link Status
<input checked="" type="checkbox"/>	1	100TX,RJ45.		Link down
<input checked="" type="checkbox"/>	2	100TX,RJ45.		Link down
<input type="checkbox"/>	4	100TX,RJ45.		Link down
<input type="checkbox"/>	6	100TX,RJ45.		Link down
<input type="checkbox"/>	7	100TX,RJ45.		100M Full
<input type="checkbox"/>	G1	1000TX,RJ45.		Link down
<input type="checkbox"/>	G2	1000TX,RJ45.		Link down

Group	Type	Member Ports
Trk1	Static	1, 2
Trk2	Static	3, 5

- Step 1:** Select the desired **Trunk Group**
- Step 2:** Select the **Trunk Type** (Static or LACP).
- Step 3:** Select the Trunk Group to modify the desired ports if necessary

### Trunk Group (maximum of 4 trunk groups)

Setting	Description	Factory Default
Trk1, Trk2, Trk3, Trk4 (depends on switching chip capability; some Moxa switches only support 3 trunk groups)	Specifies the current trunk group.	Trk1

The PT-G7728/G8728 supports 4 Trunk Groups

### Trunk Type

Setting	Description	Factory Default
Static	Selects Moxa’s static trunking protocol.	Static
LACP	Selects LACP (IEEE 802.3ad, Link Aggregation Control Protocol).	Static

## Trunking Status

The **Trunking Status table** shows the Trunk Group configuration status.

Group	Type	Member Ports	Status
Trk1	Static	3	Success
		4	Success
Trk2	LACP	5	Fail
		6	Fail

## Link-Swap Fast Recovery

The Link-Swap Fast Recovery function, which is enabled by default, allows the Moxa switch to return to normal operation extremely quickly after devices are unplugged and then re-plugged into different ports. The recovery time is on the order of a few milliseconds (compare this with standard commercial switches for which the recovery time could be on the order of several minutes). To disable the Link-Swap Fast Recovery function, or to re-enable the function after it has already been disabled, access either the Console utility's **Link-Swap recovery** page, or the Web Browser interface's **Link-Swap fast recovery** page, as shown below.



### Link-Swap-Fast-Recovery

Setting	Description	Factory Default
Enable/Disable	Select the checkbox to enable the Link-Swap-Fast-Recovery function	Enable

## RSTP Grouping

The purpose of RSTP grouping is to fulfil the legacy requirement of IEDs or PLCs that utilize RSTP to communicate with each other through the IEC 62439-3 HSR network or Moxa's proprietary architecture – Turbo Ring v2. As there is a max hops limitation when using RSTP, the quality of the devices that use RSTP is also limited. By grouping RSTP devices via assigning "RSTP Group ID", the total number of RSTP devices that are connected to Turbo Ring v2 or HSR can be extended.

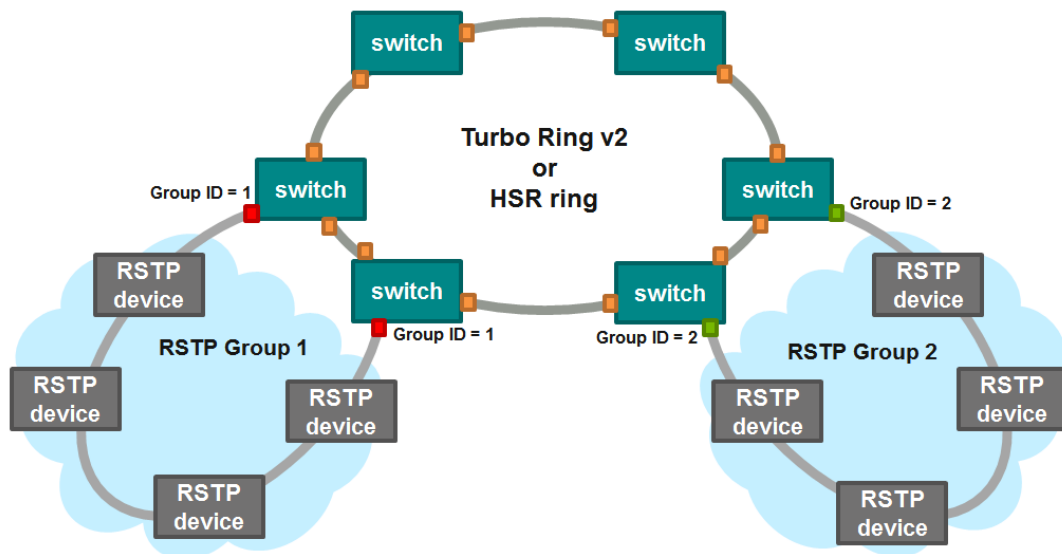



**RSTP Grouping**

Note : RSTP Grouping only available on Turbo ring v2 is enabled.

Port	Enable	Group ID	Connected Network
1	<input checked="" type="checkbox"/>	1	Turbo Ring v2 Ring 1 ▼
2	<input checked="" type="checkbox"/>	2	Turbo Ring v2 Ring 1 ▼
3	<input type="checkbox"/>	3	Turbo Ring v2 Ring 1 ▼
4	<input type="checkbox"/>	4	Turbo Ring v2 Ring 1 ▼
1-1	<input type="checkbox"/>	5	Turbo Ring v2 Ring 1 ▼
1-2	<input type="checkbox"/>	6	Turbo Ring v2 Ring 1 ▼
1-3	<input type="checkbox"/>	7	Turbo Ring v2 Ring 1 ▼
1-4	<input type="checkbox"/>	8	Turbo Ring v2 Ring 1 ▼
2-1	<input type="checkbox"/>	9	Turbo Ring v2 Ring 1 ▼
2-2	<input type="checkbox"/>	10	Turbo Ring v2 Ring 1 ▼
2-3	<input type="checkbox"/>	11	Turbo Ring v2 Ring 1 ▼

**Apply**

**Enable RSTP Grouping**

Setting	Description	Factory Default
Enable/Disable RSTP Grouping of selected port	Enable or disable RSTP Grouping of selected port	Disable

**Group ID**

Setting	Description	Factory Default
1 to 4094	The RSTP Group ID	As port number

**Connected Network**

Setting	Description	Factory Default
Turbo Ring v2 Ring 1, Turbo Ring v2 Ring 2, HSR	Select the connected network of the RSTP Grouping.	Turbo Ring v2 Ring 1

**NOTE** Moxa's PT-G7728/PT-G7828 only supports Turbo Ring v2.

# Multicast

Multicast filtering improves the performance of networks that carry multicast traffic. This section explains multicasts, multicast filtering, and how multicast filtering can be implemented on your Moxa switch.

## The Concept of Multicast Filtering

### What is an IP Multicast?

A *multicast* is a packet sent by one host to multiple hosts. Only those hosts that belong to a specific multicast group will receive the multicast. If the network is set up correctly, a multicast can only be sent to an end-station or a subset of end-stations on a LAN or VLAN that belong to the multicast group. Multicast group members can be distributed across multiple subnets, so that multicast transmissions can occur within a campus LAN or over a WAN. In addition, networks that support IP multicast send only *one* copy of the desired information across the network until the delivery path that reaches group members diverges. To make more efficient use of network bandwidth, it is only at these points that multicast packets are duplicated and forwarded. A multicast packet has a multicast group address in the destination address field of the packet's IP header.

### Benefits of Multicast

The benefits of using IP multicast are:

- It uses the most efficient, sensible method to deliver the same information to many receivers with only one transmission.
- It reduces the load on the source (for example, a server) since it will not need to produce several copies of the same data.
- It makes efficient use of network bandwidth and scales well as the number of multicast group members increases.
- Works with other IP protocols and services, such as Quality of Service (QoS).

Multicast transmission makes more sense and is more efficient than unicast transmission for some applications. For example, multicasts are often used for video-conferencing, since high volumes of traffic must be sent to several end-stations at the same time, but where broadcasting the traffic to all end-stations would cause a substantial reduction in network performance. Furthermore, several industrial automation protocols, such as Allen-Bradley, EtherNet/IP, Siemens Profibus, and Foundation Fieldbus HSE (High Speed Ethernet), use multicast. These industrial Ethernet protocols use publisher/subscriber communications models by multicasting packets that could flood a network with heavy traffic. IGMP Snooping is used to prune multicast traffic so that it travels only to those end destinations that require the traffic, reducing the amount of traffic on the Ethernet LAN.

### Multicast Filtering

Multicast filtering ensures that only end-stations that have joined certain groups receive multicast traffic. With multicast filtering, network devices only forward multicast traffic to the ports that are connected to registered end-stations. The following two figures illustrate how a network behaves without multicast filtering, and with multicast filtering.

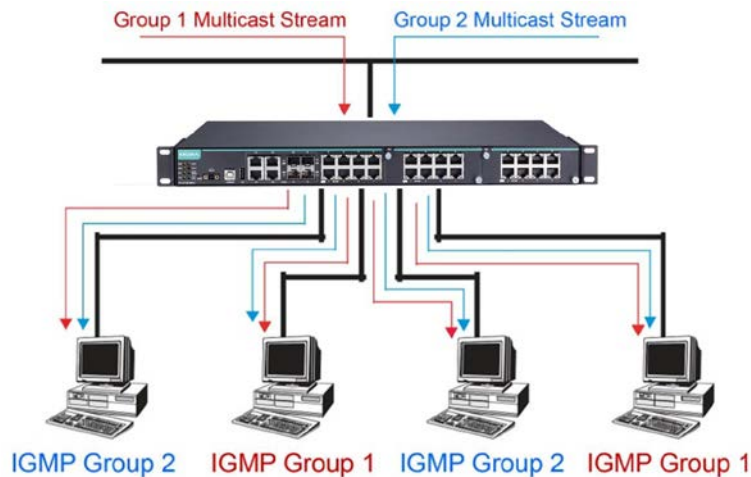
**Network without multicast filtering**

All hosts receive the multicast traffic, even if they don't need it.

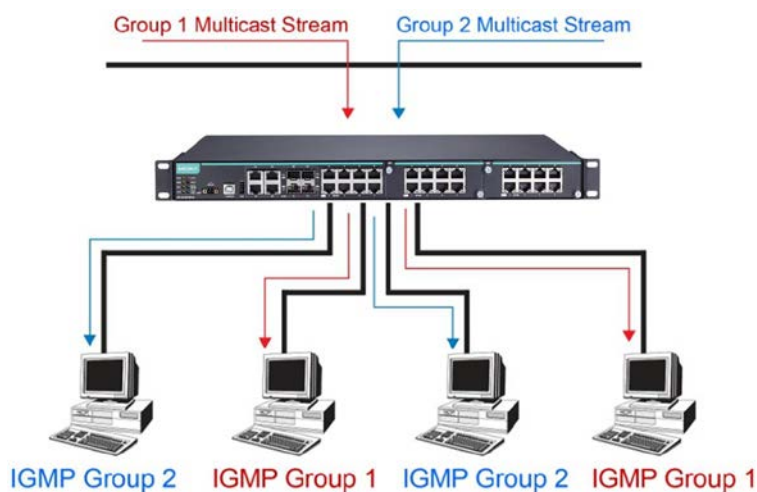
**Network with multicast filtering**

Hosts only receive dedicated traffic from other hosts belonging to the same group.

**Multicast Filtering and Moxa's Industrial Rackmount Switches**

There are three ways to achieve multicast filtering with a Moxa switch: IGMP (Internet Group Management Protocol) Snooping, GMRP (GARP Multicast Registration Protocol), and adding a static multicast MAC manually to filter multicast traffic automatically.

**Snooping Mode**

Snooping Mode allows your switch to forward multicast packets only to the appropriate ports. The switch **snoops** on exchanges between hosts and an IGMP device, such as a router, to find those ports that want to join a multicast group, and then configures its filters accordingly.

**Query Mode**

Query mode allows the Moxa switch to work as the Querier if it has the lowest IP address on the subnetwork to which it belongs.

**NOTE** IGMP Snooping Enhanced mode is only provided in Layer 2 switches.

IGMP querying is enabled by default on the Moxa switch to ensure that query election is activated. Enable query mode to run multicast sessions on a network that does not contain IGMP routers (or queriers). Query mode allows users to enable IGMP snooping by VLAN ID. Moxa switches support IGMP snooping version 1, version 2, and version 3. Version 2 is compatible with version 1. The default setting is IGMP V1/V2.

**NOTE** Moxa Layer 3 switches are compatible with any device that conforms to the IGMP v2 and IGMP v3 device protocols. Layer 2 switches only support IGMP v1/v2.

## IGMP Multicast Filtering

IGMP is used by IP-supporting network devices to register hosts with multicast groups. It can be used on all LANs and VLANs that contain a multicast capable IP router, and on other network devices that support multicast filtering. Moxa switches support IGMP version 1, 2 and 3. IGMP version 1 and 2 work as follows:

- The IP router (or querier) periodically sends query packets to all end-stations on the LANs or VLANs that are connected to it. For networks with more than one IP router, the router with the lowest IP address is the querier. A switch with IP address lower than the IP address of any other IGMP queriers connected to the LAN or VLAN can become the IGMP querier.
- When an IP host receives a query packet, it sends a report packet back that identifies the multicast group that the end-station would like to join.
- When the report packet arrives at a port on a switch with IGMP Snooping enabled, the switch knows that the port should forward traffic for the multicast group, and then proceeds to forward the packet to the router.
- When the router receives the report packet, it registers that the LAN or VLAN requires traffic for the multicast groups.
- When the router forwards traffic for the multicast group to the LAN or VLAN, the switches only forward the traffic to ports that received a report packet.

IGMP version 3 supports “source filtering,” which allows the system to define how to treat packets from specified source addresses. The system can either white-list or black-list specified sources.

### IGMP version comparison

IGMP Version	Main Features	Reference
V1	Periodic query	RFC-1112
V2	Compatible with V1 and adds: <ol style="list-style-type: none"> <li>Group-specific query</li> <li>Leave group messages</li> <li>Resends specific queries to verify leave message was the last one in the group</li> <li>Querier election</li> </ol>	RFC-2236
V3	Compatible with V1, V2, and adds: <ul style="list-style-type: none"> <li>Source filtering</li> <li>- accept multicast traffic from specified source</li> <li>- accept multicast traffic from any source except the specified source</li> </ul>	RFC-3376

## GMRP (GARP Multicast Registration Protocol)

Moxa switches support IEEE 802.1D-1998 GMRP (GARP Multicast Registration Protocol), which is different from IGMP (Internet Group Management Protocol). GMRP is a MAC-based multicast management protocol, whereas IGMP is IP-based. GMRP provides a mechanism that allows bridges and end stations to register or de-register Group membership information dynamically. GMRP functions similarly to GVRP, except that GMRP registers multicast addresses on ports. When a port receives a **GMRP-join** message, it will register the multicast address to its database if the multicast address is not registered, and all the multicast packets with that multicast address are able to be forwarded from this port. When a port receives a **GMRP-leave** message, it will de-register the multicast address from its database, and all the multicast packets with this multicast address will not be able to be forwarded from this port.

## Static Multicast MAC

Some devices may only support multicast packets, but not support either IGMP Snooping or GMRP. The Moxa switch supports adding multicast groups manually to enable multicast filtering.

## Enabling Multicast Filtering

Use the USB console or web interface to enable or disable IGMP Snooping and IGMP querying. If IGMP Snooping is not enabled, then IP multicast traffic is always forwarded, flooding the network.

## IGMP Snooping

IGMP Snooping provides the ability to prune multicast traffic so that it travels only to those end destinations that require that traffic, thereby reducing the amount of traffic on the Ethernet LAN.

**NOTE** IGMP Snooping will be disabled when Port-Based VLAN is enabled.

## IGMP Snooping Setting

### IGMP Snooping Setting

Enable IGMP Snooping      Query Interval (sec)

Enable Multicast Fast Forwarding Mode

VID	Enable IGMP Snooping	Querier	Static Multicast Querier Port
1	<input checked="" type="checkbox"/>	V1/V2 ▾	<div style="display: flex; flex-wrap: wrap; padding: 5px;"> <div style="width: 25%;"><input type="checkbox"/> 1-1</div> <div style="width: 25%;"><input type="checkbox"/> 1-2</div> <div style="width: 25%;"><input type="checkbox"/> 1-3</div> <div style="width: 25%;"><input type="checkbox"/> 1-4</div> <div style="width: 25%;"><input type="checkbox"/> 2-1</div> <div style="width: 25%;"><input type="checkbox"/> 2-2</div> <div style="width: 25%;"><input type="checkbox"/> 2-3</div> <div style="width: 25%;"><input type="checkbox"/> 2-4</div> <div style="width: 25%;"><input type="checkbox"/> 3-1</div> <div style="width: 25%;"><input type="checkbox"/> 3-2</div> <div style="width: 25%;"><input type="checkbox"/> 3-3</div> <div style="width: 25%;"><input type="checkbox"/> 3-4</div> <div style="width: 25%;"><input type="checkbox"/> 4-1</div> <div style="width: 25%;"><input type="checkbox"/> 4-2</div> <div style="width: 25%;"><input type="checkbox"/> 4-3</div> <div style="width: 25%;"><input type="checkbox"/> 4-4</div> <div style="width: 25%;"><input type="checkbox"/> 5-1</div> <div style="width: 25%;"><input type="checkbox"/> 5-2</div> <div style="width: 25%;"><input type="checkbox"/> 5-3</div> <div style="width: 25%;"><input type="checkbox"/> 5-4</div> <div style="width: 25%;"><input type="checkbox"/> 6-1</div> <div style="width: 25%;"><input type="checkbox"/> 6-2</div> <div style="width: 25%;"><input type="checkbox"/> 6-3</div> <div style="width: 25%;"><input type="checkbox"/> 6-4</div> <div style="width: 25%;"><input type="checkbox"/> 7-1</div> <div style="width: 25%;"><input type="checkbox"/> 7-2</div> <div style="width: 25%;"><input type="checkbox"/> 7-3</div> <div style="width: 25%;"><input type="checkbox"/> 7-4</div> <div style="width: 25%;"><input type="checkbox"/> 8-1</div> <div style="width: 25%;"><input type="checkbox"/> 8-2</div> <div style="width: 25%;"><input type="checkbox"/> 8-3</div> <div style="width: 25%;"><input type="checkbox"/> 8-4</div> <div style="width: 25%;"><input type="checkbox"/> 9-1</div> <div style="width: 25%;"><input type="checkbox"/> 9-2</div> <div style="width: 25%;"><input type="checkbox"/> 9-3</div> <div style="width: 25%;"><input type="checkbox"/> 9-4</div> <div style="width: 25%;"><input type="checkbox"/> 10-1</div> <div style="width: 25%;"><input type="checkbox"/> 10-2</div> <div style="width: 25%;"><input type="checkbox"/> 10-3</div> <div style="width: 25%;"><input type="checkbox"/> 10-4</div> <div style="width: 25%;"><input type="checkbox"/> 11-1</div> <div style="width: 25%;"><input type="checkbox"/> 11-2</div> <div style="width: 25%;"><input type="checkbox"/> 11-3</div> <div style="width: 25%;"><input type="checkbox"/> 11-4</div> <div style="width: 25%;"><input type="checkbox"/> 12-1</div> <div style="width: 25%;"><input type="checkbox"/> 12-2</div> <div style="width: 25%;"><input type="checkbox"/> 12-3</div> <div style="width: 25%;"><input type="checkbox"/> 12-4</div> <div style="width: 25%;"><input type="checkbox"/> 13-1</div> <div style="width: 25%;"><input type="checkbox"/> 13-2</div> <div style="width: 25%;"><input type="checkbox"/> 13-3</div> <div style="width: 25%;"><input type="checkbox"/> 13-4</div> </div>
			<div style="display: flex; flex-wrap: wrap; padding: 5px;"> <div style="width: 25%;"><input type="checkbox"/> 1-1</div> <div style="width: 25%;"><input type="checkbox"/> 1-2</div> <div style="width: 25%;"><input type="checkbox"/> 1-3</div> <div style="width: 25%;"><input type="checkbox"/> 1-4</div> <div style="width: 25%;"><input type="checkbox"/> 2-1</div> <div style="width: 25%;"><input type="checkbox"/> 2-2</div> <div style="width: 25%;"><input type="checkbox"/> 2-3</div> <div style="width: 25%;"><input type="checkbox"/> 2-4</div> <div style="width: 25%;"><input type="checkbox"/> 3-1</div> <div style="width: 25%;"><input type="checkbox"/> 3-2</div> <div style="width: 25%;"><input type="checkbox"/> 3-3</div> <div style="width: 25%;"><input type="checkbox"/> 3-4</div> <div style="width: 25%;"><input type="checkbox"/> 4-1</div> <div style="width: 25%;"><input type="checkbox"/> 4-2</div> <div style="width: 25%;"><input type="checkbox"/> 4-3</div> <div style="width: 25%;"><input type="checkbox"/> 4-4</div> <div style="width: 25%;"><input type="checkbox"/> 5-1</div> <div style="width: 25%;"><input type="checkbox"/> 5-2</div> <div style="width: 25%;"><input type="checkbox"/> 5-3</div> <div style="width: 25%;"><input type="checkbox"/> 5-4</div> </div>

Apply

### Enable IGMP Snooping (Global)

Setting	Description	Factory Default
Enable/Disable	Select the Enable IGMP Snooping checkbox near the top of the window to enable the IGMP Snooping function globally.	Disabled

### Query Interval (sec)

Setting	Description	Factory Default
Numerical value, input by the user	Sets the query interval of the Querier function globally. Valid settings are from 20 to 600 seconds.	125 seconds

### Enable Multicast Fast Forwarding Mode

Setting	Description	Factory Default
Enable/Disable	Select the Enable Multicast Fast Forwarding Mode checkbox to achieve fast multicast forwarding path re-learning while the ring redundant network is down. Note: Turbo Ring V2 or Turbo Chain must be enabled.	Disabled

### Enable IGMP Snooping

Setting	Description	Factory Default
Enable/Disable	Enables or disables the IGMP Snooping function on that particular VLAN.	Enabled if IGMP Snooping is enabled globally

**Querier**

Setting	Description	Factory Default
Disable	Disables the Moxa switch's querier function.	V1/V2
V1/V2 and V3 checkbox	V1/V2: Enables the switch to send IGMP snooping version 1 and 2 queries V3: Enables the switch to send IGMP snooping version 3 queries	

**Static Multicast Querier Port**

Setting	Description	Factory Default
Select/Deselect	Select the ports that will connect to the multicast routers. These ports will receive all multicast packets from the source. This option is only active when IGMP Snooping is enabled.	Disabled

**NOTE** If a router or layer 3 switch is connected to the network, it will act as the Querier, and consequently this Querier option will be disabled on all Moxa layer 2 switches.

If all switches on the network are Moxa layer 2 switches, then only one layer 2 switch will act as Querier.

**NOTE** Multicast Fast Forwarding Mode is one function of V-ON technology that should be enabled in layer 2 and layer 3 switches. For a detailed introduction, refer to *Moxa Managed Ethernet Switch Redundancy Protocol (UI 2.0) User's Manual*.

## IGMP Group Status

The Moxa switch displays the current active IGMP groups that were detected. On this page, you can view IGMP group settings by VLAN ID.

**IGMP Group Status**

Dynamic Router Port		Static Router Port		Querier Connected Port	Role
Group	Port	Version	Filter Mode	Sources	

The information shown in the table includes:

- Dynamic Router Port: Indicates that a multicast router connects to or sends packets from these port(s).
- Static Router Port: Displays the static multicast querier port(s).
- Querier Connected Port: Displays the port that is connected to the querier.
- Role: Indicates if the switch is a querier. Displays Querier or Non-Querier.

- Group: Displays the multicast group addresses.
- Port: Displays the port that receives the multicast stream or the port the multicast stream is forwarded to
- Version: Displays the IGMP Snooping version.
- Filter Mode: Indicates that the multicast source address is included or excluded. Displays Include or Exclude when IGMP v3 is enabled
- Sources: Displays the multicast source address when IGMP v3 is enabled

## Stream Table

This page displays the multicast stream forwarding status. It allows you to view the status by VLAN ID.

**IGMP Stream Status**

Index	Stream Group	Stream Source	Port	Member Ports
1	239.255.255.250	172.21.2.29	2	2,5

**Stream Group:** Multicast group IP address

**Stream Source:** Multicast source IP address

**Port:** The port that receives the multicast stream

**Member Ports:** Ports the multicast stream is forwarded to

**NOTE** IGMP Stream Status is only supported by Moxa's Layer 3 switches.

## Static Multicast Address

### Static Multicast Address

MAC Address  -  -  -  -  -

Member Port  1  2  3  4  5  6  7  G1  
 G2  G3

<input type="checkbox"/> All	MAC Address	Member Port

**NOTE** The MAC address (01:00:5E:XX:XX:XX) will appear on the Static Multicast Address page. Activate IGMP Snooping to implement automatic classification.

### MAC Address

Setting	Description	Factory Default
Integer	Type the MAC address in the MAC Address field to specify a static multicast address.	None

### Member Port

Setting	Description	Factory Default
Select/Deselect	Select the appropriate checkboxes to define the join ports for this multicast group.	None

## GMRP

GMRP is a MAC-based multicast management protocol, whereas IGMP is IP-based. GMRP provides a mechanism that allows bridges and end stations to register or un-register Group membership information dynamically.

### GMRP Settings

	Port
Enable GMRP	<input type="checkbox"/> 1 <input type="checkbox"/> 2 <input type="checkbox"/> 3 <input type="checkbox"/> 4 <input type="checkbox"/> 5 <input type="checkbox"/> 6 <input type="checkbox"/> 7 <input type="checkbox"/> G1 <input type="checkbox"/> G2 <input type="checkbox"/> G3

#### GMRP Status

MAC Address	Static Port	Learned Port



**Enable GMRP**

Setting	Description	Factory Default
Select/Deselect	Select the appropriate checkboxes to define which ports are to be GMRP enabled.	None

**GMRP Status**

The Moxa switch displays the current active GMRP groups that were detected.

**MAC Address:** The Multicast MAC address

**Static Port:** This multicast address is defined by static multicast

**Learned Port:** This multicast address is learned by GMRP

## Multicast Filtering Behavior

Multicast Filtering Behavior supports two options: **Forward Unknown** and **Filter Unknown**.

Port	Multicast Filtering Behavior
1	Forward Unknown ▼
2	Filter Unknown ▼
7	Forward Unknown ▼
8	Forward Unknown ▼
9	Forward Unknown ▼
10	Forward Unknown ▼
11	Forward Unknown ▼
12	Forward Unknown ▼
13	Forward Unknown ▼
14	Forward Unknown ▼
G1	Forward Unknown ▼
G2	Forward Unknown ▼
G3	Forward Unknown ▼

**Apply**

### Multicast Filtering Behavior

Setting	Description	Factory Default
Forward Unknown	Allows the switch to forward all unknown Multicast streams	Forward Unknown
Filter Unknown	Allows the switch to drop all unknown Multicast streams	

## QoS

The Moxa switch’s traffic prioritization capability provides Quality of Service (QoS) to your network by making data delivery more reliable. You can prioritize traffic on your network to ensure that high priority data is transmitted with minimum delay. Traffic can be controlled by a set of rules to obtain the required Quality of Service for your network. The rules define different types of traffic and specify how each type should be treated as it passes through the switch. The Moxa switch can inspect both IEEE 802.1p/1Q layer 2 CoS tags, and even layer 3 TOS information to provide consistent classification of the entire network. The Moxa switch’s QoS capability improves the performance and determinism of industrial networks for mission-critical applications.

## The Traffic Prioritization Concept

Traffic prioritization allows you to prioritize data so that time-sensitive and system-critical data can be transferred smoothly and with minimal delay over a network. The benefits of using traffic prioritization are:

- Improve network performance by controlling a wide variety of traffic and by managing congestion.
- Assign priorities to different categories of traffic. For example, set higher priorities for time-critical or business-critical applications.
- Provide predictable throughput for multimedia applications, such as video conferencing or voice over IP, and minimize traffic delay and jitter.
- Improve network performance as the amount of traffic grows. Doing so will reduce costs since it will not be necessary to keep adding bandwidth to the network.

Traffic prioritization uses the four traffic queues that are present in your Moxa switch to ensure that high priority traffic is forwarded on a different queue from lower priority traffic. Traffic prioritization provides Quality of Service (QoS) to your network.

Moxa switch traffic prioritization depends on two industry-standard methods:

- **IEEE 802.1D**—a layer 2 marking scheme.
- **Differentiated Services (DiffServ)**—a layer 3 marking scheme.

### IEEE 802.1D Traffic Marking

The IEEE Std 802.1D, 1998 Edition marking scheme, which is an enhancement to IEEE Std 802.1D, enables Quality of Service on the LAN. Traffic service levels are defined in the IEEE 802.1Q 4-byte tag, which is used to carry VLAN identification as well as IEEE 802.1p priority information. The 4-byte tag immediately follows the destination MAC address and Source MAC address.

The IEEE Std 802.1D, 1998 Edition priority marking scheme assigns an IEEE 802.1p priority level between 0 and 7 to each frame. The priority marking scheme determines the level of service that this type of traffic should receive. Refer to the table below for an example of how different traffic types can be mapped to the eight IEEE 802.1p priority levels.

IEEE 802.1p Priority Level	IEEE 802.1D Traffic Type
0	Best Effort (default)
1	Background
2	Standard (spare)
3	Excellent Effort (business critical)
4	Controlled Load (streaming multimedia)
5	Video (interactive media); less than 100 milliseconds of latency and jitter
6	Voice (interactive voice); less than 10 milliseconds of latency and jitter
7	Network Control Reserved traffic

Even though the IEEE 802.1D standard is the most widely used prioritization scheme for LAN environments, it still has some restrictions:

- It requires an additional 4-byte tag in the frame, which is normally optional for Ethernet networks. Without this tag, the scheme cannot work.
- The tag is part of the IEEE 802.1Q header, so to implement QoS at layer 2, the entire network must implement IEEE 802.1Q VLAN tagging.
- It is only supported on a LAN and not across routed WAN links, since the IEEE 802.1Q tags are removed when the packets pass through a router.

### Differentiated Services (DiffServ) Traffic Marking

DiffServ is a Layer 3 marking scheme that uses the DiffServ Code Point (DSCP) field in the IP header to store the packet priority information. DSCP is an advanced intelligent method of traffic marking that allows you to choose how your network prioritizes different types of traffic. DSCP uses 64 values that map to user-defined service levels, allowing you to establish more control over network traffic.

The advantages of DiffServ over IEEE 802.1D are:

- You can configure how you want your switch to treat selected applications and types of traffic by assigning various grades of network service to them.
- No extra tags are required in the packet.
- DSCP uses the IP header of a packet to preserve priority across the Internet.
- DSCP is backwards compatible with IPv4 TOS, which allows operation with existing devices that use a layer 3 TOS enabled prioritization scheme.

### Traffic Prioritization

Moxa switches classify traffic based on layer 2 of the OSI 7 layer model, and the switch prioritizes received traffic according to the priority information defined in the received packet. Incoming traffic is classified based upon the IEEE 802.1D frame and is assigned to the appropriate priority queue based on the IEEE 802.1p service level value defined in that packet. Service level markings (values) are defined in the IEEE 802.1Q 4-byte tag, and consequently traffic will only contain 802.1p priority markings if the network is configured with VLANs and VLAN tagging. The traffic flow through the switch is as follows:

- A packet received by the Moxa switch may or may not have an 802.1p tag associated with it. If it does not, then it is given a default 802.1p tag (which is usually 0). Alternatively, the packet may be marked with a new 802.1p value, which will result in all knowledge of the old 802.1p tag being lost.
- Because the 802.1p priority levels are fixed to the traffic queues, the packet will be placed in the appropriate priority queue, ready for transmission through the appropriate egress port. When the packet reaches the head of its queue and is about to be transmitted, the device determines whether or not the egress port is tagged for that VLAN. If it is, then the new 802.1p tag is used in the extended 802.1D header.
- The Moxa switch will check a packet received at the ingress port for IEEE 802.1D traffic classification, and then prioritize it based on the IEEE 802.1p value (service levels) in that tag. It is this 802.1p value that determines which traffic queue the packet is mapped to.

### Traffic Queues

The hardware of Moxa switches has multiple traffic queues that allow packet prioritization to occur. Higher priority traffic can pass through the Moxa switch without being delayed by lower priority traffic. As each packet arrives in the Moxa switch, it passes through any ingress processing (which includes classification, marking/re-marking), and is then sorted into the appropriate queue. The switch then forwards packets from each queue.

Moxa switches support two different queuing mechanisms:

- **Weight Fair:** This method services all the traffic queues, giving priority to the higher priority queues. Under most circumstances, the Weight Fair method gives high priority precedence over low priority, but in the event that high priority traffic does not reach the link capacity, lower priority traffic is not blocked.
- **Strict:** This method services high traffic queues first; low priority queues are delayed until no more high priority data needs to be sent. The Strict method always gives precedence to high priority over low priority.

## Configuring Traffic Prioritization

Quality of Service (QoS) provides a traffic prioritization capability to ensure that important data is delivered consistently and predictably. The Moxa switch can inspect IEEE 802.1p/1Q layer 2 CoS tags, and even layer 3 TOS information, to provide a consistent classification of the entire network. The Moxa switch's QoS capability improves your industrial network's performance and determinism for mission critical applications.

## CoS Classification

**QoS Classification**

**Egress Scheduling Setting**

Scheduling Mechanism Weight Fair(16:14:12:10:8:4:2:1) ▼

**Ingress Classification Setting**

Port	ToS/DSCP Inspection	CoS Inspection	Priority
1	<input checked="" type="checkbox"/>	<input checked="" type="checkbox"/>	3 ▼
2	<input checked="" type="checkbox"/>	<input checked="" type="checkbox"/>	3 ▼
3	<input checked="" type="checkbox"/>	<input checked="" type="checkbox"/>	3 ▼
4	<input checked="" type="checkbox"/>	<input checked="" type="checkbox"/>	3 ▼
1-1	<input checked="" type="checkbox"/>	<input checked="" type="checkbox"/>	3 ▼
1-2	<input checked="" type="checkbox"/>	<input checked="" type="checkbox"/>	3 ▼
1-3	<input checked="" type="checkbox"/>	<input checked="" type="checkbox"/>	3 ▼
1-4	<input checked="" type="checkbox"/>	<input checked="" type="checkbox"/>	3 ▼
2-1	<input checked="" type="checkbox"/>	<input checked="" type="checkbox"/>	3 ▼
2-2	<input checked="" type="checkbox"/>	<input checked="" type="checkbox"/>	3 ▼

### Scheduling Mechanism

Setting	Description	Factory Default
Weight Fair	The Moxa switch has 8 priority queues. In the weight fair scheme, an 16, 14, 12, 10, 8, 4, 2, 1 weighting is applied to the four priorities. This approach prevents the lower priority frames from being starved of opportunity for transmission with only a slight delay to the higher priority frames	Weight Fair
Strict	In the Strict-priority scheme, all top-priority frames egress a port until that priority's frames egress. This approach can cause the lower priorities to be starved of opportunity for transmitting frames but ensures that all high priority frames will egress the switch as soon as possible.	

### TOS/DSCP Inspection

Setting	Description	Factory Default
Enable/Disable	Enables or disables the Moxa switch for inspecting Type of Server (TOS) bits in the IPV4 frame to determine the priority of each frame.	Enable

### COS Inspection

Setting	Description	Factory Default
Enable/Disable	Enables or disables the Moxa switch for inspecting 802.1p COS tags in the MAC frame to determine the priority of each frame.	Enable

### Priority

Setting	Description	Factory Default
0 to 7	The port priority has 8 priority queues: from 0 (lowest) to 7 (highest)	3

**NOTE** The priority of an ingress frame is determined in the following order:

1. ToS/DSCP Inspection
2. CoS Inspection
3. Priority

**NOTE** The designer can enable these classifications individually or in combination. For instance, if a “hot” higher priority port is required for a network design, **TOS/DSCP Inspection** and **Cos Inspection** can be disabled. This setting leaves only port default priority active, which results in all ingress frames being assigned the same priority on that port.

## Priority Mapping

CoS	Priority Queue
0	0 ▼
1	1 ▼
2	2 ▼
3	3 ▼
4	4 ▼
5	5 ▼
6	6 ▼
7	7 ▼

0
1
2
3
4
5
6
7

### CoS Value and Priority Queues

Setting	Description	Factory Default
0 to 7	Maps different CoS values to 8 different egress queues.	CoS 0: 0 CoS 1: 1 CoS 2: 2 CoS 3: 3 CoS 4: 4 CoS 5: 5 CoS 6: 6 CoS 7: 7

## DSCP Mapping

**DSCP Mapping**

DSCP	Priority	DSCP	Priority	DSCP	Priority	DSCP	Priority
0	0 ▼	1	0 ▼	2	0 ▼	3	0 ▼
4	0 ▼	5	0 ▼	6	0 ▼	7	0 ▼
8	1 ▼	9	1 ▼	10	1 ▼	11	1 ▼
12	1 ▼	13	1 ▼	14	1 ▼	15	1 ▼
16	2 ▼	17	2 ▼	18	2 ▼	19	2 ▼
20	2 ▼	21	2 ▼	22	2 ▼	23	2 ▼
24	3 ▼	25	3 ▼	26	3 ▼	27	3 ▼
28	3 ▼	29	3 ▼	30	3 ▼	31	3 ▼
32	4 ▼	33	4 ▼	34	4 ▼	35	4 ▼
36	4 ▼	37	4 ▼	38	4 ▼	39	4 ▼

Apply

### DSCP Value and Priority

Setting	Description	Factory Default
0 to 7	Different DSCP values map to one of 8 different priorities.	0
8 to 15		1
16 to 23		2
24 to 31		3
32 to 39		4
40 to 47		5
48 to 55		6
56 to 63		7

## Rate Limiting

In general, one host should not be allowed to occupy unlimited bandwidth, particularly when the device malfunctions. For example, so-called “broadcast storms” could be caused by an incorrectly configured topology, or a malfunctioning device. Moxa industrial Ethernet switches not only prevent broadcast storms, but can also be configured to a different ingress rate for all packets, giving administrators full control of their limited bandwidth to prevent undesirable effects caused by unpredictable faults.

The **Control Mode** setting on the **Rate Limiting** page can be set to **Normal** or **Port Disable**.

### Control Mode

Setting	Description	Factory Default
Normal	Set the max. ingress rate limit for different packet types	30 seconds
Port Disable	When the ingress multicast and broadcast packets exceed the ingress rate limit, the port will be disabled for a certain period. During this period, all packets from this port will be discarded.	Unlimited

## Rate Limiting: Normal

### Ingress Rate Limit

**Rate Limiting**

Action Drop Packet ▼

Port	Ingress Policy	Ingress Threshold
1	Limit Broadcast ▼	8M ▼
2	Limit All	8M ▼
3	Limit Broadcast, Multicast, Flooded Unicast	8M ▼
4	Limit Broadcast	8M ▼
1-1	Limit Broadcast ▼	8M ▼
1-2	Limit Broadcast ▼	8M ▼
1-3	Limit Broadcast ▼	8M ▼
1-4	Limit Broadcast ▼	8M ▼
2-1	Limit Broadcast ▼	8M ▼

Policy	Description	Factory Default
Limit All	Select the ingress rate limit for different packet types from the following options: Unlimited, 128K, 256K, 512K, 1M, 2M, 4M, 8M, 10%(100Mbps), 15%(150Mbps), 25%(250Mbps), 35%(350Mbps), 50%(500Mbps), 65%(650Mbps), 85%(850Mbps)	Limit Broadcast 8M
Limit Broadcast, Multicast, Flooded Unicast		
Limit Broadcast, Multicast		
Limit Broadcast		

### Egress Rate Limit

Port	Egress Rate
13	Unlimited ▼
14	Unlimited ▼
15	Unlimited
16	3% (3Mbps)
17	5% (5Mbps)
18	10% (10Mbps)
19	15% (15Mbps)
	25% (25Mbps)
	35% (35Mbps)
	50% (50Mbps)
	65% (65Mbps)
	85% (85Mbps)

Apply

Setting	Description	Factory Default
Egress rate	Select the egress rate limit (% of max. throughput) for all packets from the following options: Not Limited, 3%, 5%, 10%, 15%, 25%, 35%, 50%, 65%, 85%	Unlimited



### Rate Limiting: Port Disable

#### Rate Limiting

Control Mode Port Disable ▾

Port Disable Duration (1~65535s)

Port	Ingress(fps of multicast and broadcast packets.)
13	Unlimited ▾
14	Unlimited
15	44640 fps
16	74410 fps
17	148810 fps
18	223220 fps
19	372030 fps
	520840 fps
	744050 fps
	Unlimited ▾

Setting	Description	Factory Default
Port disable duration (1-65535 seconds)	When the ingress packets exceed the ingress rate limit, the port will be disabled for a certain period.	30 seconds
Ingress (frames per second)	Select the ingress rate (fps) limit for all packets from the following options: Not Limited, 44640, 74410, 148810, 223220, 372030, 520840, 744050	Unlimited

## Security

Security can be categorized into two levels: the user name/password level, and the port access level. Moxa switches provide many kinds of security functions, including Management Interface, Trusted Access, SSL/SSH Authentication certificate, Login Authentication, IEEE 802.1X, MAC Authentication Bypass, Port Security, Broadcast Storm Protection, Loop Protection, and Access Control List.

## Management Interface

#### Management Interface

- Enable HTTP TCP Port
- Enable HTTPS TCP Port
- Enable Telnet TCP Port
- Enable SSH TCP Port
- Enable SNMP TCP Port
- Enable Moxa Service TCP Port  UDP Port
- Enable Moxa Service(Encrypted) TCP Port  UDP Port
- Maximum Login Users For HTTP+HTTPS  (1~10)
- Maximum Login Users For Telnet+SSH  (1~5)
- Auto Logout Setting (min)  (0~1440; 0 for Disable)

**Enable HTTP**

Setting	Description	Factory Default
Select/Deselect	Select the appropriate checkboxes to enable HTTP.	TCP Port: 80

**Enable HTTPS**

Setting	Description	Factory Default
Select/Deselect	Select the appropriate checkboxes to enable HTTPS.	TCP Port: 443

**Enable Telnet**

Setting	Description	Factory Default
Select/Deselect	Select the appropriate checkboxes to enable Telnet.	TCP Port: 23

**Enable SSH**

Setting	Description	Factory Default
Select/Deselect	Select the appropriate checkboxes to enable SSH.	TCP Port: 22

**Enable SNMP**

Setting	Description	Factory Default
Select/Deselect	Select the appropriate checkboxes to enable SNMP.	TCP Port: 161

**Enable Moxa Service**

Setting	Description	Factory Default
Select/Deselect	Select the appropriate checkboxes to enable Moxa Service. NOTE: Moxa Service is only for Moxa network management software suite.	TCP Port: 4000 UDP Port: 4000

**Enable Moxa Service (Encrypted)**

Setting	Description	Factory Default
Select/Deselect	Select the appropriate checkboxes to enable Moxa Service (Encrypted). NOTE: Moxa Service (Encrypted) is only for Moxa network management software suite.	TCP Port: 443 UDP Port: 40404

**Maximum Login Users for HTTP+HTTPS**

Setting	Description	Factory Default
Integer (1 to 10)	Sets the maximum number of login users for HTTP and HTTPS	5

**Maximum Login Users for Telnet+SSH**

Setting	Description	Factory Default
Integer (1 to 5)	Sets the maximum number of login users for Telnet and SSH	1

**Auto Logout Setting (min)**

Setting	Description	Factory Default
Integer (0 to 1440)	Sets the web auto logout period. (Enter 0 to disable this function.)	5

## Trusted Access

The Moxa switch uses an IP address-based filtering method to control access.

### Trusted Access

Enable trusted access Apply

Please add your local IP address first, otherwise, your PC will not be able to connect the device again

All	IP Address	Subnet Mask
<input type="checkbox"/>		0(0.0.0.0) ▼
<input type="checkbox"/>		0(0.0.0.0) ▼
<input type="checkbox"/>		0(0.0.0.0) ▼
<input type="checkbox"/>		0(0.0.0.0) ▼
<input type="checkbox"/>		0(0.0.0.0) ▼
<input type="checkbox"/>		0(0.0.0.0) ▼
<input type="checkbox"/>		0(0.0.0.0) ▼
<input type="checkbox"/>		0(0.0.0.0) ▼
<input type="checkbox"/>		0(0.0.0.0) ▼
<input type="checkbox"/>		0(0.0.0.0) ▼
<input type="checkbox"/>		0(0.0.0.0) ▼

Delete

You may add or remove IP addresses to limit access to the Moxa switch. When the Trusted Access list is enabled, only addresses on the list will be allowed access to the Moxa switch. Each IP address and netmask entry can be tailored for different situations:

- **Grant access to one host with a specific IP address**  
 For example, enter IP address 192.168.1.1 with netmask 255.255.255.255 to allow access to 192.168.1.1 only.
- **Grant access to any host on a specific subnetwork**  
 For example, enter IP address 192.168.1.0 with netmask 255.255.255.0 to allow access to all IPs on the subnet defined by this IP address/subnet mask combination.
- **Grant access to all hosts**  
 Make sure the Trusted Access list is not enabled by removing the checkmark from **Enable trusted access**.

The following table shows additional configuration examples:

Hosts That Need Access	Input Format
Any host	Disable
192.168.1.120	192.168.1.120 / 255.255.255.255
192.168.1.1 to 192.168.1.254	192.168.1.0 / 255.255.255.0
192.168.0.1 to 192.168.255.254	192.168.0.0 / 255.255.0.0
192.168.1.1 to 192.168.1.126	192.168.1.0 / 255.255.255.128
192.168.1.129 to 192.168.1.254	192.168.1.128 / 255.255.255.128

## SSL Certificate Management

### SSL Certificate Management

CA Name	Expiry Date
Moxa Networking Co., Ltd.	Nov 12 08:18:23 2032 GMT

**Certificate Import**

PKCS#12 Upload  **Browse**

Import Password  **Import**

**Certificate Re-generate**

Re-generate **Apply**

### Certificate Import

1. Click **Browse** and select Public-Key Cryptography Standard (PKCS) #12 certificate file
2. Enter the **Import Password** and click **Import**
3. The SSL certificate is updated

### Regenerate SSL Certificate

Setting	Description	Factory Default
Select/Deselect	Enable the SSL Certificate Regeneration	Deselect

## SSH Key Management

### SSH Key Management

**SSH Key**

Re-generate

Note: Few minutes may be required. Web will be unavailable temporarily until it finish.

**Apply**

### SSH Key Re-generate

Setting	Description	Factory Default
Select/Deselect	Enable SSH Key Re-generate	Deselect

## Authentication

### Login Authentication

Moxa switches provide three different user login authentications: TACACS+ (Terminal Access Controller Access-Control System Plus), RADIUS (Remote Authentication Dial In User Service), and Local. The TACACS+ and RADIUS mechanisms are centralized "AAA" (Authentication, Authorization and Accounting) systems for connecting to network services. The fundamental purpose of both TACACS+ and RADIUS is to provide an efficient and secure mechanism for user account management.

There are five combinations for users:

1. **TACACS+, Local:** Check TACACS+ database first. If checking the TACACS+ database fails, then check the Local database
2. **RADIUS, Local:** Check RADIUS database first. If checking the RADIUS database fails, then check the Local database
3. **TACACS+:** Only check TACACS+ database
4. **RADIUS:** Only check the RADIUS database
5. **Local:** Only check the Local database

### Login Authentication

Authentication Protocol:

Server IP/Name:

TCP Port:

Shared Key:

Authentication Type:

Timeout (sec):

[Apply](#)

### Login Authentication

Authentication Protocol:

Server IP/Name:

UDP Port:

Shared Key:

Authentication Type:

Timeout (sec):

[Apply](#)

### Login Authentication

Authentication Protocol:

[Apply](#)

Setting	Description	Factory Default
Authentication Protocol	Authentication protocol selection.	Local
Server IP/Name	Sets the IP address of an external TACACS+/RADIUS server as the authentication database.	None
TCP/UDP Port	Sets the communication port of an external TACACS+/RADIUS server as the authentication database.	TACACS+: 49 RADIUS: 1812
Shared Key	Sets specific characters for server authentication verification.	None
Authentication Type	Authentication mechanism selection. ASCII, PAP, CHAP, and MSCHAP are for TACACS+; PAP and CHAP are for RADIUS.	ASCII for TACACS+ PAP for RADIUS
Timeout (sec)	The timeout period for waiting for a server response.	3

**NOTE** The account privilege level is authorized under service type settings in RADIUS, and the privilege level is under TACACS+.

RADIUS Server

- RADIUS Service type = 6 = read/write = administrator
- RADIUS Service type = 1 = read only = user

TACACS+ Server

- TACACS+ privilege level= 15 = read/write = administrator
- TACACS+ privilege level= 1 to 14 = read only = user

## IEEE 802.1X Settings

The IEEE 802.1X standard defines a protocol for client/server-based access control and authentication. The protocol restricts unauthorized clients from connecting to a LAN through ports that are open to the Internet, and which otherwise would be readily accessible. The purpose of the authentication server is to check each client that requests access to the port. The client is only allowed access to the port if the client's permission is authenticated.

Three components are used to create an authentication mechanism based on 802.1X standards: Client/Supplicant, Authentication Server, and Authenticator.

**Client/Supplicant:** The end station that requests access to the LAN and switch services and responds to the requests from the switch.

**Authentication Server:** The server that performs the actual authentication of the supplicant.

**Authenticator:** Edge switch or wireless access point that acts as a proxy between the supplicant and the authentication server, requesting identity information from the supplicant, verifying the information with the authentication server, and relaying a response to the supplicant.

The Moxa switch acts as an authenticator in the 802.1X environment. A supplicant and an authenticator exchange EAPOL (Extensible Authentication Protocol over LAN) frames with each other. We can either use an external RADIUS server as the authentication server, or implement the authentication server in the Moxa switch by using a Local User Database as the authentication look-up table. When we use an external RADIUS server as the authentication server, the authenticator and the authentication server exchange EAP frames.

Authentication can be initiated either by the supplicant or the authenticator. When the supplicant initiates the authentication process, it sends an **EAPOL-Start** frame to the authenticator. When the authenticator initiates the authentication process or when it receives an **EAPOL Start** frame, it sends an **EAP Request/Identity** frame to ask for the username of the supplicant.

### IEEE 802.1X Settings

Authentication Protocol: 802.1X Local ▼

Re-Auth: Enable ▼

Re-Auth Period (sec): 3600

Port	Enable 802.1X	Re-Auth
1	<input type="checkbox"/>	<input type="checkbox"/>
2	<input type="checkbox"/>	<input type="checkbox"/>
3	<input type="checkbox"/>	<input type="checkbox"/>
4	<input type="checkbox"/>	<input type="checkbox"/>
5	<input type="checkbox"/>	<input type="checkbox"/>
6	<input type="checkbox"/>	<input type="checkbox"/>
7	<input type="checkbox"/>	<input type="checkbox"/>

**Apply**

**Authentication Protocol**

Setting	Description	Factory Default
802.1X Local (Max. of 32 users)	Select this option when setting the 802.1X Local User Database as the authentication database.	802.1X Local
RADIUS	Select this option to set an external RADIUS server as the authentication database. The authentication mechanism is EAP-MD5.	
RADIUS, 802.1X Local	Select this option to make using an external RADIUS server as the authentication database the first priority. The authentication mechanism is EAP-MD5. The second priority is to set the 802.1X Local User Database as the authentication database.	

**Re-Auth (Global)**

Setting	Description	Factory Default
Enable/Disable	Select enable to require re-authentication of the client after a preset time period of no activity has elapsed.	Enable

**Re-Auth Period (sec)**

Setting	Description	Factory Default
60 to 65535	Sets the Re-Auth period	3600

**Enable 802.1X**

Setting	Description	Factory Default
Select/Deselect	Select the checkbox under the 802.1X column to enable IEEE 802.1X for one or more ports. All end stations must enter usernames and passwords before access to these ports is allowed.	Deselect

**Re-Auth**

Setting	Description	Factory Default
Select/Deselect	Select enable to require re-authentication of the client by port	Deselect

## IEEE 802.1X Local Database

When selecting the 802.1X Local as the authentication protocol, set the IEEE 802.1X Local Database first.

### IEEE 802.1X Local Database

User Name

Password

Confirm Password

Description

<input type="checkbox"/>	User Name	Password	Description
All			

### IEEE 802.1X Local Database Setup

Setting	Description	Factory Default
User Name (Max. of 30 characters)	User Name for the Local User Database	None
Password (Max. of 16 characters)	Password for the Local User Database	None
Confirm Password (Max. of 16 characters)	Confirm Password for the Local User Database	None
Description (Max. of 30 characters)	Description for the Local User Database	None

**NOTE** The user name for the IEEE 802.1X Local Database is case-insensitive.



## MAC Authentication Bypass Settings

**MAC Authentication Bypass Settings**

Authentication Protocol:

Re-Auth:

Re-Auth Period (sec):

Re-Start:

Re-Start Period (sec):

Port	Enable MAC Authentication Bypass
1	<input type="checkbox"/>
2	<input type="checkbox"/>
3	<input type="checkbox"/>
4	<input type="checkbox"/>
5	<input type="checkbox"/>
6	<input type="checkbox"/>
7	<input type="checkbox"/>
8	<input type="checkbox"/>

**Authentication Protocol**

Setting	Description	Factory Default
RADIUS	RADIUS is the only authentication protocol of the MAC Authentication Bypass	RADIUS

**Re-Auth**

Setting	Description	Factory Default
Enable/Disable	Select enable to require re-authentication of the client after a preset time period of no activity has elapsed	Disable

**Re-Auth Period (sec)**

Setting	Description	Factory Default
60 to 65535	Sets the Re-Auth period	3600

**Re-Start**

Setting	Description	Factory Default
Enable/Disable	Select enable to require a present time period to re-start authentication after failure of authentication	Disable

**Re-Start Period (sec)**

Setting	Description	Factory Default
5 to 300	Sets the Re-Start period	60

**Enable MAC Authentication Bypass**

Setting	Description	Factory Default
Select/Deselect	Check the checkbox under the MAC Authentication Bypass column to enable MAC Authentication Bypass for one or more ports	Deselect

**NOTE** If RADIUS Server is case sensitive, use lower-case characters for the username and password.

## RADIUS Server Settings

### RADIUS Server Settings

Apply Login Authentication Settings

1<sup>st</sup> Server IP/Name

UDP Port

Shared Key

2<sup>nd</sup> Server IP/Name

UDP Port

Shared Key

### Apply Login Authentication Setting

Setting	Description	Factory Default
Select/Deselect	Enables using the same setting as Auth Server.	Deselect

### Server Setting

Setting	Description	Factory Default
Server IP/Name	Specifies the IP/name of the server	None
Server Port	Specifies the port of the server	1812
Server Shared Key	Specifies the shared key of the server	None

## Port Security

Moxa switches provide a Port Security function that lets packets with allowed MAC Addresses access the switch's ports. Two Port Security modes are supported: **Static Port Lock** and **MAC Address Sticky**.

**Static Port Lock:** Allows users to configure specific MAC addresses that are allowed to access the port.

**MAC Address Sticky:** Allows users to configure the maximum number of MAC addresses (the Limit) that a port can "learn." Users can configure what action should be taken (under Violation Port Disable) when a new MAC address tries to access a port after the maximum number of MAC addresses have already been learned. The total number of allowed MAC addresses cannot exceed 1024.

## Port Security Mode

### Port Security Mode

Port	Mode	Limit	Violation Port Disable
1	Static Port Lock ▼	1	Disabled ▼
2	MAC Address Sticky ▼	1	Disabled ▼
3	--- ▼	1	Disabled ▼
4	--- ▼	1	Disabled ▼
5	--- ▼	1	Disabled ▼
6	--- ▼	1	Disabled ▼
7	--- ▼	1	Disabled ▼
8	--- ▼	1	Disabled ▼
9	--- ▼	1	Disabled ▼
10	--- ▼	1	Disabled ▼
11	--- ▼	1	Disabled ▼
12	--- ▼	1	Disabled ▼
13	--- ▼	1	Disabled ▼
14	--- ▼	1	Disabled ▼
G1	--- ▼	1	Disabled ▼
G2	--- ▼	1	Disabled ▼
G3	--- ▼	1	Disabled ▼
G4	--- ▼	1	Disabled ▼

Apply

### Mode

Setting	Description	Factory Default
Static Port Lock	The switch will block unauthorized MAC addresses and allow access to packets with a MAC address defined in the Static Unicast MAC Address Table.	None
MAC Address Sticky	If Limit is set to n, the switch will learn the first n MAC addresses that access the port, and automatically store them in the MAC Address Control Table.	

### Limit (only active for MAC Address Sticky)

Setting	Description	Factory Default
1 to 1024	The maximum number of learned MAC addresses allowed for that port.	1

### Violation Port Disable (only active for MAC Address Sticky)

Setting	Description	Factory Default
Disable	When the port receives a packet with an unlearned MAC address, the packet will be discarded.	Disable
Enable	When the port receives a packet with an unlearned MAC address, the port will be disabled.	

## Static Port Lock

### Static Port Lock

**Add Static Unicast MAC Address**

Port

VID

MAC Address  -  -  -  -  -

**Static Unicast MAC Address Table**

Port

All	Mac Address	Vid	Type
■			

**Port Number**

Setting	Description	Factory Default
Port Number	Associates the static address to a dedicated port	None

**VID**

Setting	Description	Factory Default
VLAN ID	Associates the static address to a dedicated VLAN on the port	None

**MAC Address**

Setting	Description	Factory Default
MAC Address	Adds the static unicast MAC address into the address table	None

## MAC Address Sticky

### MAC Address Sticky

**Add Static Unicast MAC Address**

Port

VID

MAC Address  -  -  -  -  -

**MAC Access Control Table**

Port

Number: 0

Total/MAX: 0/1024

<input type="checkbox"/> All	Index	MAC Address	VID	Status

**Port Number**

Setting	Description	Factory Default
Port Number	Associates the static address to a dedicated port	None

**VID**

Setting	Description	Factory Default
VLAN ID	Associates the static address to a dedicated VLAN on the port	None

**MAC Address**

Setting	Description	Factory Default
MAC Address	Adds the static unicast MAC address into the address table	None

## Port Access Control Table

### Port Access Control Table

Port 1 ▼

Total Entries:0

All	MAC Address	Status

Delete

The port status will be indicated as **authorized** or **unauthorized**.

## Loop Protection

### Loop Protection

Enable

Apply

### Enable Loop Protection

Setting	Description	Factory Default
Enable	Select the Enable checkbox to enable the loop protection function.	Disable
Disable	Deselect the Enable checkbox to disable the loop protection function.	

## Access Control List

**NOTE** PT-G7728 switches only support Ingress ACL.

Access control lists (ACLs) increase the flexibility and security of networking management. ACLs provide traffic filtering capabilities for ingress and egress packets. Moxa ACLs can manage filter criteria for a diverse range of protocols and allow users to configure customized filter criteria. For example, users can deny access to specific source or destination IP/MAC addresses. The Moxa ACL configuration interface is easy to use. Users can quickly establish filtering rules, manage rule priorities, and view overall settings on the display page.

## The ACL Concept

### What is ACL?

An access control list is a basic traffic filter for ingress and egress packets. The ACL can examine each Ethernet packet's information and take the necessary action. Moxa Layer 3 switches provide complete filtering capabilities. Access list criteria could include the source or destination IP address of the packets, the source or destination MAC address of the packets, IP protocols, or other information. The ACL can check these criteria to decide whether to permit or deny access to a packet.

### Benefits of ACL

ACLs support per interface, per packet direction, and per protocol filtering capability. These features can provide basic protection by filtering specific packets. The main benefits of an ACL are:

- **Manage authority of hosts:** An ACL can restrict specific devices through MAC address filtering. The user can deny all packets or only permit packets that come from specific devices.
- **Subnet authority management:** Configure filtering rules for specific subnet IP addresses. An ACL can restrict packets from or to specific subnets.
- **Network security:** The demand for networking security is growing. An ACL can provide basic protection that works in a similar manner to an Ethernet firewall device.
- **Control traffic flow by filtering specific protocols:** An ACL can filter specific IP protocols such as TCP or UDP packets.

### How an ACL Works

The ACL working structure is based on access lists. Each access list is a filter. When a packet enters into or exits from a switch, the ACL will compare the packet to the rules in the access lists, starting from the first rule. If a packet is rejected or accepted by the first rule, the switch will drop or pass this packet directly without checking the rest of the lower-priority rules. In other words, Access Control Lists have "Priority Index" as an attribute to define the priority in the web configuration console.

There are two types of settings for an ACL: list settings and rule settings. In order to be created, an Access Control List needs the following list settings: Name, Priority Index, Filter Type, and Ports to Apply. Once created, each Access Control List has its own set of rule settings. Priority Index represents the priority of the names in the access list. Names at Priority Index 1 have first priority in packet filtering. The Priority Index is adjustable whenever users need to change the priority. Two types of packet filtering can be used:

- IP based
- MAC Based

The filter type defines whether the access list will examine packets based on IP or MAC address. The type affects what detailed rules can be edited. You can then assign the ports you would like to apply the list to. You can also define Ingress and Egress per port.

After adding a new access control list, you can also create new rules for the access control list. Each ACL group accepts 10 rules. Rules can filter packets by source and destination IP/MAC address, IP protocol, TCP/UDP Port, Ethernet Type, and VLAN ID.

After all rules are set, the ACL starts to filter the packets by the rule with the highest Priority Index (smaller number, higher priority). Once a rule denies or accepts its access, the packet will be dropped or passed.

## Access Control List Configuration and Setup

### Access Control Profile Settings

#### Access Control Profile Settings

ACL ID

Name

Filter Name

	ACL ID	Name	Filter Mode
<input type="checkbox"/>	1	<input type="text" value="ProtectionSetting"/>	IP Based
<input type="checkbox"/>	2	<input type="text" value="VLANfilter"/>	IP Based
<input type="checkbox"/>	3	<input type="text" value="DeviceGroupA"/>	MAC Based
<input type="checkbox"/>	4	<input type="text" value="FilterIPA"/>	IP Based
<input type="checkbox"/>	5	<input type="text" value="DeviceGroupB"/>	MAC Based
<input type="checkbox"/>	6	<input type="text" value="PLCA"/>	MAC Based

On this page, you can configure two settings: (1) Add/Modify Access Control list, and (2) Adjust ACL ID.

#### Add/Modify Access Control List

This function lets you add a new access control profile or modify an existing access control profile. The operation depends on the ACL ID you select. If the selected ACL ID is still empty, you can start by creating a new access control profile. Parameters for editing are as follows:

- **ACL ID:** The ACL checking sequence is based on these IDs. Smaller ID numbers have a higher priority for packet filtering. If a packet is filtered by an access control profile with a higher priority, those access control profiles with a lower priority will not be executed.  
Note that the ACL ID is not unique with respect to the profile name. The ID changes when swapping the priority of different access control profiles.  
The maximum Priority Index number is 16.
- **Name:** You can name the access control profile in this field.
- **Filter Name:** Select filtering by either IP or MAC address. Detailed settings can be configured in the Access Control Rule Settings page.

If a selected ACL ID is already in the access control list, then you can modify the parameters listed above. After the configuration is complete, click Apply to confirm the settings. A new list will appear in the Access Control List Table.

#### Adjust ACL ID

Changing an established access control profile's priority is easy. Moxa provides a simple interface to let you easily adjust the priority. Follow the three steps below to adjust the priority:

**Step 1:** Select the profile

**Step 2:** Click the **Up/Down** button to adjust the sequence. The ACL ID will change with the profile's position.

**Step 3:** Click the **Apply** button to confirm the settings.



## Access Control Rule Settings

You can edit access control rules on this page. Each ACL includes up to 10 rules. First, select the access control profile you would like to edit based on the ACL ID, and then set up the rule content and ingress/egress ports. After configuring, click the Add button to add the rule to the list. Finally, click Apply to activate the settings.

An access control rule displays setting options based on the filtering type used:

### IP Based (Layer 2 Device)

#### Access Control Rule Settings

ACL ID	Filter Mode
1 - ProtectionSetting ▾	IP Based

Action: Permit ▾

Source IP Address: Any ▾ 0.0.0.0

Source IP Address Mask: 0.0.0.0

Destination IP Address: Any ▾ 0.0.0.0

Destination IP Address Mask: 0.0.0.0

IP Protocol: User Defined ▾ 0x00

TCP/UDP Source Port:

TCP/UDP Destination Port:

Up
Down
Add
Delete
Modify
Apply

All	Index	Action	Source IP Address	Destination IP Address	IP Protocol	TCP/UDP source port	TCP/UDP destination port
<input type="checkbox"/>	1	Deny	Any	192.128.127.200/255.255.255.255			
<input type="checkbox"/>	2	Permit	192.168.127.100/255.255.255.255	Any			

**Ingress Port**

1  2  3  4

5  6  7  8

9  10  11  12

13  14  G1  G2

G3  G4

### IP Based (Layer 3 Device)

#### Access Control Rule Settings

ACL ID  
1 - ProtectionSetting ▾

Filter Mode  
IP Based

Action Deny ▾

Source IP Address Any ▾ 0.0.0.0

Source IP Address Mask 0.0.0.0

Destination IP Address Any ▾ 0.0.0.0

Destination IP Address Mask 0.0.0.0

IP Protocol User Defined ▾ 0x

TCP/UDP Source Port

TCP/UDP Destination Port

Up Down Add Delete Modify Apply

All	Index	Action	Source IP Address	Destination IP Address	IP Protocol	TCP/UDP source port	TCP/UDP destination port
<input type="checkbox"/>	1	Deny	Any	192.168.127.0/255.255.255.0	0x02		
<input type="checkbox"/>	2	Permit	192.168.127.100/255.255.255.255	Any	0x01		

Ingress Port

3-1  3-2  3-3  3-4

4-1  4-2  4-3  4-4

5-1  5-2  5-3  5-4

6-1  6-2  6-3  6-4

7-1  7-2  7-3  7-4

8-1  8-2  8-3  8-4

9-1  9-2  9-3  9-4

10-1  10-2  10-3  10-4

11-1  11-2  11-3  11-4

12-1  12-2  12-3  12-4

13-1  13-2  13-3  13-4

Egress Port

3-1  3-2  3-3  3-4

4-1  4-2  4-3  4-4

5-1  5-2  5-3  5-4

6-1  6-2  6-3  6-4

7-1  7-2  7-3  7-4

8-1  8-2  8-3  8-4

9-1  9-2  9-3  9-4

10-1  10-2  10-3  10-4

11-1  11-2  11-3  11-4

12-1  12-2  12-3  12-4

13-1  13-2  13-3  13-4

- **Action:** Whether to deny or permit access if the rule criterion is met.
- **Source (Destination) IP Address / IP Address Mask:** Defines the IP address rule. By using the mask, you can assign specific subnet ranges to filter. It allows checking the source or destination of the packet. Choose **Any** if you do not need to use this criteria.
- **IP Protocol:** Select the type of protocols to be filtered. Moxa provides ICMP, IGMP, IP over IP, TCP, and UDP as options in this field.
- **TCP/UDP Source (Destination) Port:** If TCP or UDP are selected as the filtering protocol, these fields will allow you to enter port numbers for filtering.

MAC Based (Layer 2 Device)

### Access Control Rule Settings

<b>ACL ID</b>		<b>Filter Mode</b>					
3 - DeviceGroup.A		MAC Based					
Action	Deny						
Source MAC Address	Any	00:00:00:00:00:00					
Source MAC Address Mask	00:00:00:00:00:00						
Destination MAC Address	Any	00:00:00:00:00:00					
Destination MAC Address Mask	00:00:00:00:00:00						
<input type="checkbox"/> Ether Type	User Defined	0x0000					
<input type="checkbox"/> VID							
<b>Up</b>	<b>Down</b>	<b>Add</b>	<b>Delete</b> <b>Modify</b> <b>Apply</b>				
All	Index	Action	Source MAC Address	Destination MAC Address	Ether Type	Vlan Id	
<input type="checkbox"/>	1	Deny	Any	00:90:E8:19:BE:3B/FF:FF:FF:FF:FF:FF	0x8892		
<input type="checkbox"/>	2	Deny	Any	00:90:E8:29:AD:95/FF:FF:FF:FF:FF:FF	0x8892	20	
<b>Ingress Port</b>							
1	<input type="checkbox"/>	2	<input type="checkbox"/>	3	<input type="checkbox"/>	4	<input type="checkbox"/>
5	<input type="checkbox"/>	6	<input type="checkbox"/>	7	<input type="checkbox"/>	8	<input type="checkbox"/>
9	<input type="checkbox"/>	10	<input type="checkbox"/>	11	<input type="checkbox"/>	12	<input type="checkbox"/>
13	<input type="checkbox"/>	14	<input type="checkbox"/>	G1	<input type="checkbox"/>	G2	<input type="checkbox"/>
G3	<input type="checkbox"/>	G4	<input type="checkbox"/>				

MAC Based (Layer 3 Device)

### Access Control Rule Settings

<b>ACL ID</b>		<b>Filter Mode</b>	
3 - DeviceGroupA		MAC Based	
Action	Deny		
Source MAC Address	Any	00:00:00:00:00:00	
Source MAC Address Mask	00:00:00:00:00:00		
Destination MAC Address	Any	00:00:00:00:00:00	
Destination MAC Address Mask	00:00:00:00:00:00		
<input type="checkbox"/> Ether Type	User Defined	0x0000	
<input type="checkbox"/> VID			
<b>Up</b>	<b>Down</b>	<b>Add</b>	<b>Delete</b> <b>Modify</b> <b>Apply</b>

All	Index	Action	Source MAC Address	Destination MAC Address	Ether Type	Vlan Id
<input type="checkbox"/>	1	Deny	Any	00:90:E8:19:BE:3B/FF:FF:FF:FF:FF:FF	0x0806	10
<input type="checkbox"/>	2	Permit	00:90:E8:29:AD:95/FF:FF:FF:FF:FF:FF	Any	0x8892	20

Ingress Port				Egress Port			
1-1	<input type="checkbox"/>	1-2	<input type="checkbox"/>	1-3	<input type="checkbox"/>	1-4	<input type="checkbox"/>
2-1	<input type="checkbox"/>	2-2	<input type="checkbox"/>	2-3	<input type="checkbox"/>	2-4	<input type="checkbox"/>
3-1	<input type="checkbox"/>	3-2	<input type="checkbox"/>	3-3	<input type="checkbox"/>	3-4	<input type="checkbox"/>
4-1	<input type="checkbox"/>	4-2	<input type="checkbox"/>	4-3	<input type="checkbox"/>	4-4	<input type="checkbox"/>
5-1	<input type="checkbox"/>	5-2	<input type="checkbox"/>	5-3	<input type="checkbox"/>	5-4	<input type="checkbox"/>
6-1	<input type="checkbox"/>	6-2	<input type="checkbox"/>	6-3	<input type="checkbox"/>	6-4	<input type="checkbox"/>
7-1	<input type="checkbox"/>	7-2	<input type="checkbox"/>	7-3	<input type="checkbox"/>	7-4	<input type="checkbox"/>
8-1	<input type="checkbox"/>	8-2	<input type="checkbox"/>	8-3	<input type="checkbox"/>	8-4	<input type="checkbox"/>
9-1	<input type="checkbox"/>	9-2	<input type="checkbox"/>	9-3	<input type="checkbox"/>	9-4	<input type="checkbox"/>
10-1	<input type="checkbox"/>	10-2	<input type="checkbox"/>	10-3	<input type="checkbox"/>	10-4	<input type="checkbox"/>
11-1	<input type="checkbox"/>	11-2	<input type="checkbox"/>	11-3	<input type="checkbox"/>	11-4	<input type="checkbox"/>

- **Action:** Whether to deny or permit access if the rule criterion is met.
- **Source (Destination) MAC Address / MAC Address Mask:** Defines the MAC address rule. By using the mask, you can assign specific MAC address ranges to filter. It allows checking the source or destination of the packet. Choose **Any** if you do not need to use this criterion.
- **Ethernet Type:** Select the type of Ethernet protocol to filter. Options are IPv4, ARP, RARP, IPv6, IEE802.3, PROFIENT, LLDP, and IEEE1588.
- **VLAN ID:** Enter a VLAN ID you would like to filter by.

Once ready, click the **Add** button to add the rule to the list and set up the ingress/egress ports, and then click **Apply** to activate the settings.

## Access Control List Table

The Access Control List Table page provides a complete view of all ACL settings. On this page, you can view the rules by Ingress port, Egress port, or ACL ID. Click the drop-down menu to select Port or ACL ID, and all the rules will be displayed in the table.

**ACL Table**

Port		Direction				
1-1 ▼		Ingress ▼				
ACL ID	Filter Mode	Port				
1 - ProtectionSetting ▼	IP Based	1-1,				
Index	Action	Source IP Address	Destination IP Address	IP Protocol	TCP/UDP source port	TCP/UDP destination port
1	Deny	Any	192.168.127.0/255.255.255.0	0x02		
2	Permit	192.168.127.100/255.255.255.255	Any	0x01		

## DHCP

### IP-Port Binding

**IP-Port Binding**

Port	Current IP Address	Designated IP Address
1	NA	<input type="text"/>
2	NA	<input type="text"/>
3	NA	<input type="text"/>
4	NA	<input type="text"/>
5	NA	<input type="text"/>
6	NA	<input type="text"/>
7	NA	<input type="text"/>
G1	NA	<input type="text"/>
G2	NA	<input type="text"/>
G3	NA	<input type="text"/>

**Designated IP Address**

Setting	Description	Factory Default
IP Address	Set the desired IP of connected devices.	None

## DHCP Relay Agent

The DHCP Relay Agent makes it possible for DHCP broadcast messages to be sent over routers. The DHCP Relay Agent enables DHCP clients to obtain IP addresses from a DHCP server on a remote subnet, or those that are not located on the local subnet.

## DHCP Relay Agent (Option 82)

Option 82 is used by the relay agent to insert additional information into the client's DHCP request. The Relay Agent Information option is inserted by the DHCP relay agent when forwarding client-originated DHCP packets to a DHCP server. Servers can recognize the Relay Agent Information option and use the information to implement IP addresses to Clients.

When Option 82 is enabled on the switch, a subscriber device is identified by the switch port through which it connects to the network (in addition to its MAC address). Multiple hosts on the subscriber LAN can be connected to the same port on the access switch and are uniquely identified.

The Option 82 information contains 2 sub-options, Circuit ID and Remote ID, which define the relationship between the end device IP and the DHCP Option 82 server. The **Circuit ID** is a 4-byte number generated by the Ethernet switch—a combination of physical port number and VLAN ID. The format of the **Circuit ID** is shown below:

### FF-VV-VV-PP

This is where the first byte "FF" is fixed to "01", the second and the third byte "VV-VV" is formed by the port VLAN ID in hex, and the last byte "PP" is formed by the port number in hex. For example:

01-00-0F-03 is the "Circuit ID" of port number 3 with port VLAN ID 15.

The "Remote ID" identifies the relay agent itself and can be one of the following:

1. The IP address of the relay agent.
2. The MAC address of the relay agent.
3. A combination of IP address and MAC address of the relay agent.
4. A user-defined string.

### DHCP Relay Agent

1st Server

2nd Server

3rd Server

4th Server

Enable Option 82

Assign Remote-ID by IP

Remote-ID

Port	Circuit-ID	Option 82
1	01000101	<input type="checkbox"/> Enable
2	01000102	<input type="checkbox"/> Enable
3	01000103	<input type="checkbox"/> Enable
4	01000104	<input type="checkbox"/> Enable
5	01000105	<input type="checkbox"/> Enable
6	01000106	<input type="checkbox"/> Enable
7	01000107	<input type="checkbox"/> Enable

## Server IP Address

### 1st Server

Setting	Description	Factory Default
IP address for the 1st DHCP server	Assigns the IP address of the 1st DHCP server that the switch tries to access.	None

### 2nd Server

Setting	Description	Factory Default
IP address for the 2nd DHCP server	Assigns the IP address of the 2nd DHCP server that the switch tries to access.	None

### 3rd Server

Setting	Description	Factory Default
IP address for the 3rd DHCP server	Assigns the IP address of the 3rd DHCP server that the switch tries to access.	None

### 4th Server

Setting	Description	Factory Default
IP address for the 4th DHCP server	Assigns the IP address of the 4th DHCP server that the switch tries to access.	None

## DHCP Option 82

### Enable Option 82

Setting	Description	Factory Default
Enable or Disable	Enable or disable the DHCP Option 82 function.	Disable

### Assign Remote-ID by

Setting	Description	Factory Default
IP	Uses the switch's IP address as the remote ID sub.	IP
MAC	Uses the switch's MAC address as the remote ID sub.	IP
Client-ID	Uses a combination of the switch's MAC address and IP address as the remote ID sub.	IP
Other	Uses the user-designated ID sub.	IP

### Value

Setting	Description	Factory Default
Max. of 12 characters	Displays the value that was set. Complete this field if type is set to Other.	Switch IP address

### Remote-ID

Setting	Description	Factory Default
read-only	The actual hexadecimal value configured in the DHCP server for the Remote-ID. This value is automatically generated according to the Value field. Users cannot modify it.	COA87FFD

## DHCP Function Table

### Enable

Setting	Description	Factory Default
Enable or Disable	Enable or disable the DHCP Option 82 function for this port.	Disable

## SNMP

The Moxa switch supports SNMP V1, V2c, and V3. SNMP V1 and SNMP V2c use a community string match for authentication, which means that SNMP servers access all objects with read-only or read/write permissions using the community strings *public* and *private* by default. SNMP V3 requires that you select an

authentication level of MD5 or SHA, and is the most secure protocol. You can also enable data encryption to enhance data security.

Supported SNMP security modes and levels are shown in the following table. Select the security mode and level that will be used to communicate between the SNMP agent and manager.

Protocol Version	UI Setting	Authentication	Encryption	Method
SNMP V1, V2c	V1, V2c Read Community	Community string	No	Uses a community string match for authentication.
	V1, V2c Write/Read Community	Community string	No	Uses a community string match for authentication.
SNMP V3	No-Auth	No	No	Uses an account with admin or user to access objects
	MD5 or SHA	Authentication based on MD5 or SHA	No	Provides authentication based on HMAC-MD5, or HMAC-SHA algorithms. 8-character passwords are the minimum requirement for authentication.
	MD5 or SHA	Authentication based on MD5 or SHA	Data encryption key	Provides authentication based on HMAC-MD5 or HMAC-SHA algorithms, and data encryption key. 8-character passwords and a data encryption key are the minimum requirements for authentication .and encryption.

**NOTE** The username and password of SNMP V3 are the same as the username and password of User Account. Accounts with admin privilege have read/write access to all configuration parameters. Accounts with user authority only have read access to configuration parameters.

These parameters are configured on the SNMP page. A more detailed explanation of each parameter is given below the figure.

## SNMP

SNMP Versions V1, V2c, V3 ▾

Admin Auth. Type No-Auth ▾

Enable Admin Data Encryption

User Auth. Type No-Auth ▾

Enable User Data Encryption

**Community**

V1,V2c Read Community public

V1,V2c Write/Read Community private

**Trap/inform Recipient**

Trap Mode Trap V1 ▾

Host IP Address 1 [ ]

1st Trap Community public

Host IP Address 2 [ ]

2nd Trap Community public

Data Encryption Key [ ]

Data Encryption Key [ ]

Apply



## SNMP Read/Write Settings

### SNMP Versions

Setting	Description	Factory Default
V1, V2c, V3, or V1, V2c, or V3 only	Specifies the SNMP protocol version used to manage the switch.	V1, V2c

### V1, V2c Read Community

Setting	Description	Factory Default
Max. 30 characters	Specifies the community string to authenticate the SNMP agent for read-only access. The SNMP agent will access all objects with read-only permissions using this community string.	Public

### V1, V2c Write/Read Community

Setting	Description	Factory Default
Max. 30 characters	Specifies the community string to authenticate the SNMP agent for read/write access. The SNMP server will access all objects with read/write permissions using this community string.	Private

For SNMP V3, two levels of privilege are available for accessing the Moxa switch. **Admin** privilege provides access and authorization to read and write the MIB file. **User** privilege only allows reading the MIB file.

### Admin Auth. Type (for SNMP V1, V2c, V3, and V3 only)

Setting	Description	Factory Default
No-Auth	Allows the admin account to access objects without authentication.	No
MD5-Auth	Authentication will be based on the HMAC-MD5 algorithms. 8-character passwords are the minimum requirement for authentication.	No
SHA-Auth	Authentication will be based on the HMAC-SHA algorithms. 8-character passwords are the minimum requirement for authentication.	No

### Enable Admin Data Encryption Key (for SNMP V1, V2c, V3, and V3 only)

Setting	Description	Factory Default
Enable	Enables data encryption using the specified data encryption key (between 8 and 30 characters).	No
Disable	Specifies that data will not be encrypted.	No

### User Auth. Type (for SNMP V1, V2c, V3 and V3 only)

Setting	Description	Factory Default
No-Auth	Allows the admin account and user account to access objects without authentication.	No
MD5-Auth	Authentication will be based on the HMAC-MD5 algorithms. 8-character passwords are the minimum requirement for authentication.	No
SHA-Auth	Authentication will be based on the HMAC-SHA algorithms. 8-character passwords are the minimum requirement for authentication.	No

### Enable User Data Encryption Key (for SNMP V1, V2c, V3 and V3 only)

Setting	Description	Factory Default
---------	-------------	-----------------

Enable	Enables data encryption using the specified data encryption key (between 8 and 30 characters).	No
Disable	No data encryption	No

## Trap Settings

SNMP traps allow an SNMP agent to notify the NMS of a significant event. The switch supports two SNMP modes: **Trap** mode and **Inform** mode.

### SNMP Trap Mode—Trap

In Trap mode, the SNMP agent sends an SNMP trap PDU to the NMS. No acknowledgment is sent back from the NMS so the agent has no way of knowing if the trap reached the NMS.

#### SNMP Trap V1, Trap V2c

**Trap/Inform Recipient**

Mode Trap V1 ▼

Host IP Address 1

1st Trap Community

Host IP Address 2

2nd Trap Community

**Trap/Inform Recipient**

Mode Trap V2c ▼

Host IP Address 1

1st Trap Community

Host IP Address 2

2nd Trap Community

#### Host IP Address 1

Setting	Description	Factory Default
IP or name	Specifies the IP address or name of the primary trap server used by your network.	None

#### 1st Trap Community

Setting	Description	Factory Default
Max. 30 characters	Specifies the community string to use for authentication.	Public

#### Host IP Address 2

Setting	Description	Factory Default
IP or name	Specifies the IP address or name of the secondary trap server used by your network.	None

#### 2nd Trap Community

Setting	Description	Factory Default
Max. 30 characters	Specifies the community string to use for authentication.	Public

## SNMP Trap V3

Trap/Inform Recipient	
Mode	Trap V3
User Name	<input type="text"/>
Auth. Type	No-Auth
Auth. Password	<input type="password"/>
<input type="checkbox"/> Enable Data Encryption	Data Encryption Key <input type="password"/>
Host IP Address 1	<input type="text"/>
Host IP Address 2	<input type="text"/>

*User Name*

Setting	Description	Factory Default
Max. 30 characters	Specifies the user name for authentication.	NA

*Auth. Type*

Setting	Description	Factory Default
No-Auth	Allows the admin account to access objects without authentication.	No-Auth
MD5-Auth	Authentication will be based on the HMAC-MD5 algorithms. 8-character passwords are the minimum requirement for authentication.	
SHA-Auth	Authentication will be based on the HMAC-SHA algorithms. 8-character passwords are the minimum requirement for authentication.	

*Enable Data Encryption Key*

Setting	Description	Factory Default
Enable	Enables data encryption using the specified data encryption key (between 8 and 30 characters).	NA
Disable	No data encryption	NA

*Data Encryption Key*

Setting	Description	Factory Default
Max. 30 characters	Specifies the string to use for authentication.	NA

## SNMP Trap Mode—Inform

SNMPv2c, SNMPv3 provides an inform mechanism. When an inform message is sent from the SNMP agent to the NMS, the receiver sends a response to the sender acknowledging receipt of the event. This behavior is similar to that of the get and set requests. If the SNMP agent does not receive a response from the NMS for a set period of time, the agent will resend the trap to the NMS agent. The maximum timeout time is 300 sec (default is 10 sec), and the maximum number of retries is 99 times (default is 3 times). When the SNMP agent receives acknowledgement from the NMS, it will stop resending the inform messages.

### SNMPv2C Inform

Trap/Inform Recipient	
Mode	Inform V2c ▼
Retries(1~99)	3
Timeout(1~300s)	10
Host IP Address 1	
1st Trap Community	public
Host IP Address 2	
2nd Trap Community	public

#### Host IP Address 1

Setting	Description	Factory Default
IP or name	Specifies the IP address or name of the primary trap server used by your network.	NA

#### 1st Trap Community

Setting	Description	Factory Default
Max. 30 characters	Specifies the community string to use for authentication.	Public

#### Host IP Address 2

Setting	Description	Factory Default
IP or name	Specifies the IP address or name of the secondary trap server used by your network.	None

#### 2nd Trap Community

Setting	Description	Factory Default
Max. 30 characters	Specifies the community string to use for authentication.	Public

SNMP V3 version is based on SNMP V2c enhance security features, through the identification and encryption of data, providing the following security features:

1. Ensure that the information must be sent from a legal source.
2. Encrypt the transmitted data to ensure the confidentiality of the data.
3. Use the password principle to ensure that the data of transmission process will not be tampered with.

## SNMPv3 Inform

Trap/Inform Recipient	
Mode	Inform V3
User Name	<input type="text"/>
Auth. Type	No-Auth
Auth. Password	<input type="password"/>
<input type="checkbox"/> Enable Data Encryption	Data Encryption Key <input type="password"/>
Retries(1~99)	3
Timeout(1~300s)	10
Host IP Address 1	<input type="text"/>
Host IP Address 2	<input type="text"/>

**User Name**

Setting	Description	Factory Default
Max. 30 characters	Specifies the user name for authentication.	NA

**Auth. Type**

Setting	Description	Factory Default
No-Auth	Allows the admin account to access objects without authentication.	No-Auth
MD5-Auth	Authentication will be based on the HMAC-MD5 algorithms. 8-character passwords are the minimum requirement for authentication.	
SHA-Auth	Authentication will be based on the HMAC-SHA algorithms. 8-character passwords are the minimum requirement for authentication.	

**Enable Data Encryption Key**

Setting	Description	Factory Default
Enable	Enables data encryption using the specified data encryption key (between 8 and 30 characters).	NA
Disable	No data encryption	NA

**Data Encryption Key**

Setting	Description	Factory Default
Max. 30 characters	Specifies the string to use for authentication.	NA

## SNMP Trap/Inform Summary

The table below shows the SNMP protocol version applicable to PT-G7728/PT-G7828 SNMP trap/inform services and the associated authentication and authorization settings that can be configured via web console. Please note that the SNMP protocol version set in the agent (switch) is only downward compatible with the protocol version set in the trap/inform services. Therefore, SNMP protocol version v1, v2c does not allow Trap/Inform v3.

SNMP Protocol Version	Available Trap Mode	Authentication for Trap/Inform	Authorization for Trap/Inform	Message
SNMP v1, v2c, v3  Or  SNMP v3	Trap v1	No	No	Plain text
	Trap v2c	No	No	Plain text
	Inform v2c	No	No	Plain text
	Trap v3	MD5 or SHA authentication in Trap/Inform recipient section	Data encryption key in Trap/Inform recipient section	Encrypted
	Inform v3	MD5 or SHA authentication in Trap/Inform recipient section	Data encryption key in Trap/Inform recipient section	Encrypted
SNMP v1, v2c	Trap v1	No	No	Plain text
	Trap v2c	No	No	Plain text
	Inform v2c	No	No	Plain text

## Industrial Protocols

The Moxa switch supports 3 industrial protocols, EtherNet/IP, Modbus TCP, and PROFINET I/O. All three protocols can be enabled or disabled by checking the appropriate checkbox. Modbus TCP is enabled by default, with the other two options disabled.

**Industrial Protocol**

**EtherNet/IP**

Enable EtherNet/IP  
**Note:** IGMP snooping will be automatically enabled when EtherNet/IP is activated.

**Modbus TCP**

Enable Modbus TCP

**PROFINET I/O**

Enable PROFINET I/O

**Apply**

- NOTE**
1. IGMP Snooping and IGMP Query functions will be enabled automatically to be properly integrated in Rockwell systems for multicast Implicit (I/O) Messaging for efficient EtherNet/IP communication.
  2. EtherNet/IP can't be enabled while IGMP snooping is disabled due to VLAN setting.
  3. The ICS-G7700A series and ICS-G7800A series only support EtherNet/IP and Modbus TCP.

# Diagnostics

The Moxa switch provides three important tools for administrators to diagnose network systems: LLDP, Ping, and Port Mirror.

## LLDP

### Overview

LLDP is an OSI Layer 2 protocol defined by IEEE 802.11AB. LLDP standardizes the self-identification advertisement method, and allows each networking device, such as a Moxa managed switch, to periodically send its system and configuration information to its neighbors. Because of this, all LLDP devices are kept informed of each other's status and configuration, and with SNMP, this information can be transferred to Moxa's MXview for auto-topology and network visualization.

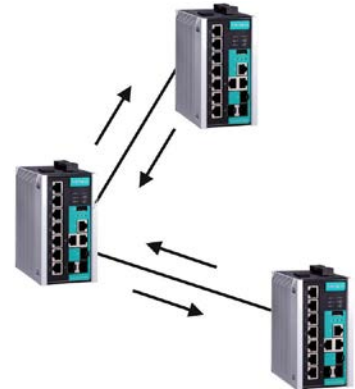

From the switch's web interface, you can enable or disable LLDP, and set the LLDP transmit interval. In addition, you can view each switch's neighbor-list, which is reported by its network neighbors. Most importantly, enabling the LLDP function allows Moxa's MXview to automatically display the network's topology and system setup details, such as VLAN and Trunking, for the entire network.

### Configuring LLDP Settings

**LLDP**

Enable LLDP

Message Transmit Interval (sec)

**Apply**

Port	Neighbor ID	Neighbor Port	Neighbor Port Description	Neighbor System
------	-------------	---------------	---------------------------	-----------------

### General Settings

#### LLDP

Setting	Description	Factory Default
Enable or Disable	Enables or disables the LLDP function.	Enable

#### Message Transmit Interval

Setting	Description	Factory Default
5 to 32768 sec.	Sets the transmit interval of LLDP messages, in seconds.	5 (seconds)

### LLDP Table

The LLDP Table displays the following information:

<b>Port</b>	The port number that connects to the neighbor device.
<b>Neighbor ID</b>	A unique entity (typically the MAC address) that identifies a neighbor device.
<b>Neighbor Port</b>	The port number of the neighbor device.
<b>Neighbor Port Description</b>	A textual description of the neighbor device's interface.
<b>Neighbor System</b>	Hostname of the neighbor device.

## Ping

The **Ping** function uses the *ping* command to give users a simple but powerful tool for troubleshooting network problems. The function's most unique feature is that even though the ping command is entered from the user's PC keyboard, the actual ping command originates from the Moxa switch itself. In this way, the user can essentially sit on top of the Moxa switch and send ping commands out through its ports.

To use the Ping function, type in the desired IP address, and then press **Enter** from the Console utility, or click **Ping** when using the Web Browser interface.

## Port Mirroring

The **Port Mirroring** function can be used to monitor data being transmitted through a specific port. This is done by setting up another port (the mirror port) to receive the same data being transmitted from, or both to and from, the port under observation. Using a mirror port allows the network administrator to **sniff** the observed port to keep tabs on network activity.

### Port Mirroring Settings

Setting	Description
Monitored Port	Select which ports will be monitored.
Sniffer Mode	Select one of the following three watch direction options: <ul style="list-style-type: none"> <li>• <b>RX</b>: Select this option to monitor only those data packets coming into the Moxa switch's port.</li> <li>• <b>TX</b>: Select this option to monitor only those data packets being sent out through the Moxa switch's port.</li> <li>• <b>TX/RX</b>: Select this option to monitor data packets both coming into, and being sent out through, the Moxa switch's port.</li> </ul>
Mirror Port	Select the number of the port that will be used to monitor the activity of the monitored port.

## Monitoring

You can monitor statistics in real time from the Moxa switch's web console and USB console.



## CPU/Memory Utilization

The CPU/Memory Utilization page displays the status of system resources. Monitor this information to quickly and easily understand the working status of the switch.

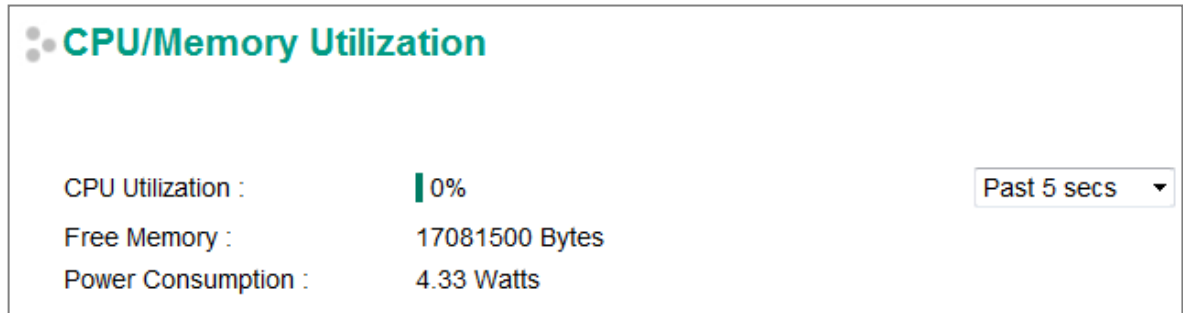

### CPU Utilization

Setting	Description	Factory Default
Read-only	The CPU usage volume in the past 5 seconds, 30 seconds, and 5 minutes	Past 5 secs

### Free Memory

Setting	Description	Factory Default
Read-only	The switch's current free memory	None

### Power Consumption

Setting	Description	Factory Default
Read-only	The current system power consumption information. The measurement tolerance is 7% (Unit: watts.)	None

## Statistics

Access the Monitor by selecting **Monitoring** from the left selection bar. Monitor by System allows the user to view a graph that shows the combined data transmission activity of all of the Moxa switch's 18 ports. Click one of the four options—**Total Packets**, **TX Packets**, **RX Packets**, or **Error Packets**—to view transmission activity of specific types of packets. Recall that TX Packets are packets sent out from the Moxa switch, RX Packets are packets received from connected devices, and Error Packets are packets that did not pass TCP/IP's error checking algorithm. The Total Packets option displays a graph that combines TX, RX, and TX Error, RX Error Packet activity. The graph displays data transmission activity by showing **Packets/s** (i.e., packets per second, or pps) versus **sec.** (seconds). In fact, three curves are displayed on the same graph: **Uni-cast** packets (in red color), **Multi-cast** packets (in green color), and **Broad-cast** packets (in blue color). The graph is updated every few seconds, allowing the user to analyze data transmission activity in real-time.

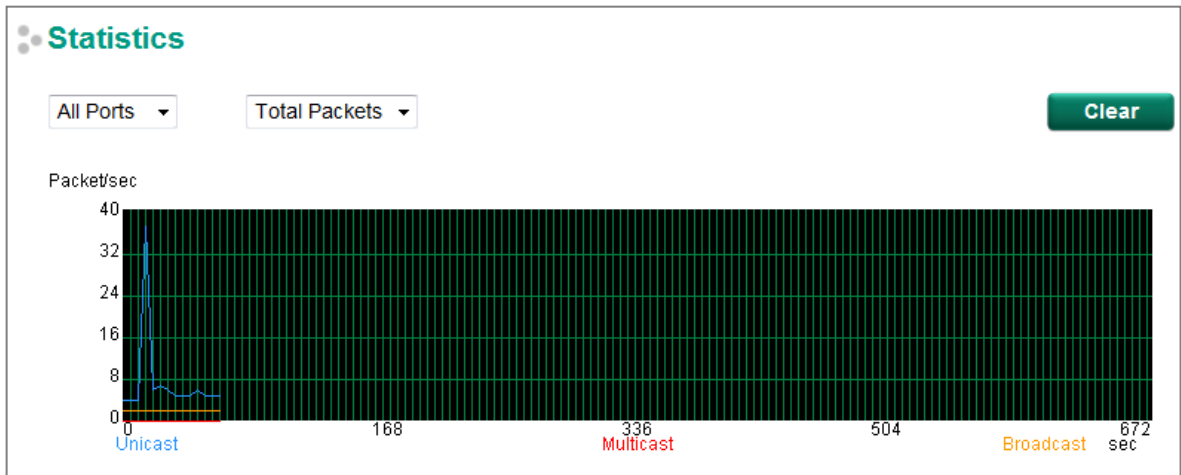

[Format] Total Packets + Packets in past 5 secs Update Interval: every 5 secs

Port	Tx	Tx Error	Rx	Rx Error
1	0+0	0+0	0+0	0+0
2	16927+54	0+0	25077+50	0+0
3	0+0	0+0	0+0	0+0
4	0+0	0+0	0+0	0+0
5	0+0	0+0	0+0	0+0
6	0+0	0+0	0+0	0+0
7	1375+1	0+0	184+0	0+0
G1	0+0	0+0	0+0	0+0
G2	0+0	0+0	0+0	0+0

**Monitor by Port**

Access the Monitor by Port function by selecting **FE or GE Ports** or **Port i**, in which  $i = 1, 2, \dots, G2$ , from the left pull-down list. The **Port i** options are identical to the Monitor by System function discussed above, in that users can view graphs that show All Packets, TX Packets, RX Packets, or Error Packets activity, but in this case, only for an individual port. The **All Ports** option is essentially a graphical display of the individual port activity that can be viewed with the Console Monitor function discussed above. The All Ports option shows three vertical bars for each port. The height of the bar represents **Packets/s** for the type of packet, at the instant the bar is being viewed. That is, as time progresses, the height of the bar moves up or down so that the user can view the change in the rate of packet transmission. The blue colored bar shows **Uni-cast** packets, the red colored bar shows **Multi-cast** packets, and the orange colored bar shows **Broad-cast** packets. The graph is updated every few seconds, allowing the user to analyze data transmission activity in real-time.

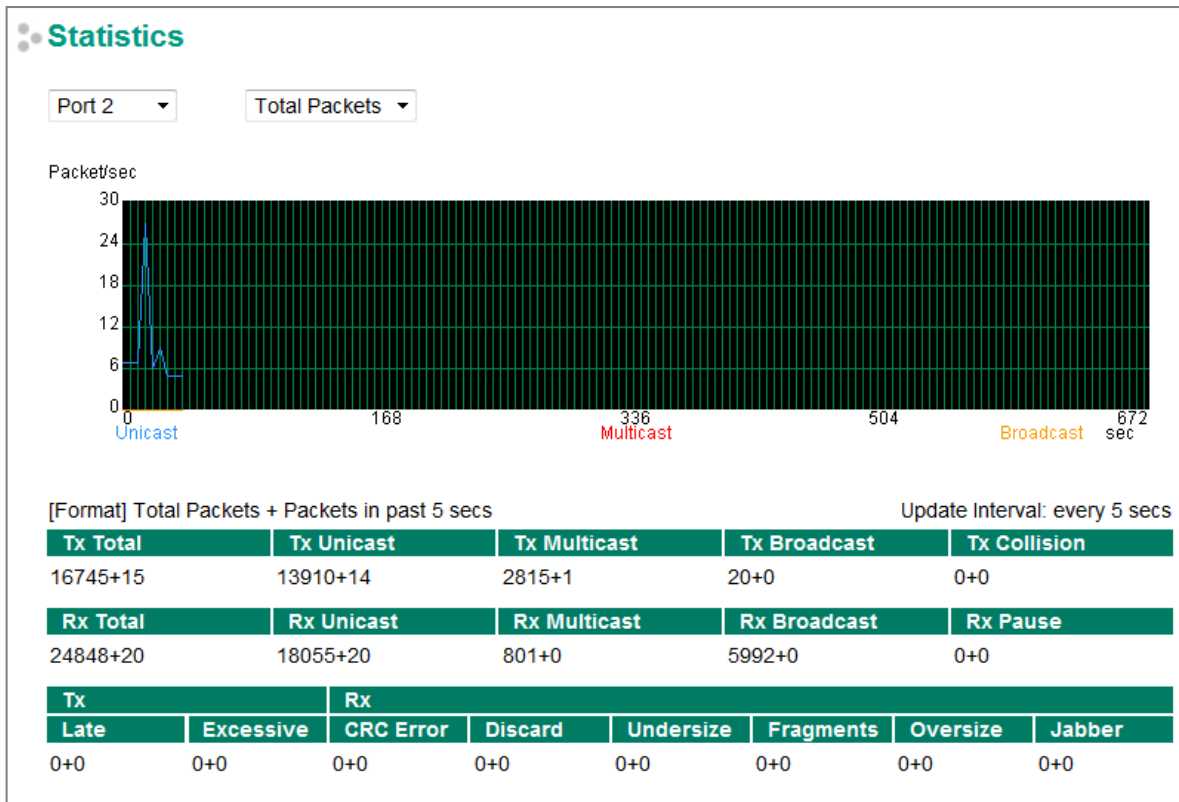

## Fiber Digital Diagnostics Monitoring (Fiber Check)

Optical fiber is commonly used for long distance data transmission. However, when link issues occur, it is very costly to troubleshoot fiber cables and fiber transceivers at remote sites. To solve this problem, Moxa industrial Ethernet switches provide digital diagnostics and monitoring (DDM) functions on Moxa SFP's and/or fixed type (multi-mode SC/ST and single-mode SC connectors) optical fiber links and allow users to measure optical parameters and its performance from a central site. This function can greatly facilitate the troubleshooting process for optical fiber links and reduce costs for onsite debugging.

### Fiber Check

Fiber Check is used to diagnose the link status of fiber connectors, including SFP and fixed type (Multi-mode SC/ST & Single-mode SC) connectors. Monitor the temperature, TX/RX power, and other parameters on fiber ports to determine if the ports are working properly. Enable the trap, email warning, and/or relay warning functions on the System Event Settings page to receive an alarm or relay if one of the fiber ports exceeds the threshold for that port.

**Fiber Check**

Port	Model Name	Wavelength (nm)	Vcc (V)	Temperature (°C)		Tx Power (dBm)		Rx Power (dBm)	
				Current	Max.	Current	Max./Min.	Current	Min.
13	FESSC	1310	3.3	43.8	120.0	-0.9	3.0/-8.0	N/A	-34.0
14	FESSC	1310	3.3	45.5	120.0	-1.7	3.0/-8.0	N/A	-34.0
G1	SFP-1GLXLC	1310	3.3	51.0	100.0	-6.2	0.0/-12.5	N/A	-20.0
G2	SFP-1GLXLC	1310	3.3	52.8	100.0	-6.8	0.0/-12.5	N/A	-20.0
G3	SFP-1GSXLC-T 850	850	3.3	48.6	110.0	-6.4	-1.0/-12.5	N/A	-18.0
G4	SFP-1GSXLC-T 850	850	3.3	49.3	110.0	-4.6	-1.0/-12.5	N/A	-18.0

Parameter	Description
-----------	-------------

Port	Switch port number with a fiber connection.
Model Name	Moxa SFP/fixed type fiber model name.
Wavelength (nm)	Wavelength of the fiber connection.
Vcc (V)	Voltage supply to the fiber connection.
Temperature (°C) – Current	Fiber connection current temperature.
Temperature (°C) – Max.	Fiber connection Max. temperature threshold.
Tx power (dBm) – Current	The current amount of light being transmitted into the fiber optic cable.
Tx power (dBm) – Max.	The Max. threshold of light being transmitted into the fiber optic cable.
Tx power (dBm) - Min.	The Min. threshold of light being transmitted into the fiber optic cable.
Rx power (dBm) – Current	The current amount of light being received from the fiber optic cable.
Rx power (dBm) – Max.	The Max. threshold of light being received from the fiber optic cable.

## Fiber Check Threshold Values

Model Name	Temperature Threshold (°C)	Tx Power (Max./Min.) (dBm)	Rx Power (Min.) (dBm)
FEMST	120	-11.0/-23.0	-31.0
FEMSC	120	-11.0/-23.0	-31.0
FESSC	120	3.0/-8.0	-34.0
SFP-1FEMLC-T	120	-5.0/-21.0	-37.0
SFP-1FESLC-T	120	3.0/-8.0	-37.0
SFP-1FELLC-T	120	3.0/-8.0	-37.0
SFP-1GSXLC-T	110	-1.0/-12.5	-18.0
SFP-1GLSXLC-T	120	2.0/-12.0	-19.0
SFP-1GLXLC-T	120	0.0/-12.5	-20.0
SFP-1GLHLC-T	120	1.0/-11.0	-23.0
SFP-1GLHXLC-T	120	4.0/-7.0	-24.0
SFP-1GZXLC-T	120	8.0/-3.0	-24.0
SFP-1G10ALC-T	120	0.0/-12.0	-21.0
SFP-1G10BLC-T	120	-5.0/-21.0	-34.0
SFP-1G20ALC-T	120	1.0/-11.0	-23.0
SFP-1G20BLC-T	120	-5.0/-21.0	-34.0
SFP-1G40ALC-T	120	5.0/-6.0	-23.0
SFP-1G40BLC-T	120	-5.0/-21.0	-34.0
SFP-1GSXLC	100	-1.0/-12.5	-18.0
SFP-1GLSXLC	100	2.0/-12.0	-19.0
SFP-1GLXLC	100	0.0/-12.5	-20.0
SFP-1GLHLC	100	1.0/-11.0	-23.0
SFP-1GLHXLC	100	4.0/-7.0	-24.0
SFP-1GZXLC	100	8.0/-3.0	-24.0
SFP-1GEZXLC	100	8.0/-3.0	-30.0
SFP-1GEZXLC-120	100	6.0/-5.0	-33.0
SFP-1G10ALC	100	0.0/-12.0	-21.0
SFP-1G10BLC	100	-5.0/-21.0	-34.0
SFP-1G20ALC	100	1.0/-11.0	-23.0
SFP-1G20BLC	100	-5.0/-21.0	-34.0
SFP-1G40ALC	100	5.0/-6.0	-23.0
SFP-1G40BLC	100	-5.0/-21.0	-34.0

**NOTE** Certain tolerances exist between real data and measured data.

## Event Log

### Event Log

Page 48/48

Index	Bootup Number	Date	Time	System Startup Time	Event
706	125	--	--	0d2h52m41s	Port 2 link on
707	125	--	--	0d3h0m49s	192.168.127.66 admin Auth. ok
708	125	--	--	0d3h6m4s	192.168.127.66 admin Auth. ok
709	125	--	--	0d3h11m56s	Port 7 link on
710	125	--	--	0d3h12m14s	Port 7 link off
711	125	--	--	0d3h12m16s	Port 7 link on
712	125	--	--	0d3h12m18s	Port 7 link off
713	125	--	--	0d3h12m19s	Port 7 link on
714	125	--	--	0d3h30m39s	192.168.127.66 admin Auth. ok

Clear
Refresh

The Event Log Table displays the following information:

Index	Event index assigned to identify the event sequence.
Bootup Number	This field shows how many times the Moxa switch has been rebooted or cold started.
Date	The date is updated based on how the current date is set in the Basic Setting page.
Time	The time is updated based on how the current time is set in the Basic Setting page.
System Startup Time	The system startup time related to this event.
Event	Events that have occurred.

**NOTE** The following events will be recorded into the Moxa switch’s Event Log Table:

- Cold start
- Warm start
- Configuration change activated
- Power 1/2 transition (Off ( On), Power 1/2 transition (On ( Off))
- Authentication fail
- Topology changed
- Master setting is mismatched
- Port traffic overload
- dot1x Auth Fail
- Port link off/on

## Tracking Function

This function is only available on the PT-G7828

The tracking function allows users to monitor the destined interface or the port availability. The tracking function is a mechanism that is designed to complement defective current protocols, which provides better redundancy for the overall system.

The device will continuously monitor the status of the tracked interface or port, and transfer these status changes into the action. e.g. enable the port, decrease the priority of the VRRP interface and activate the routing interface.

Moxa's devices provide 3 types of tracking functions: Interface Tracking, Ping Tracking, and Logic Tracking. A maximum of 64 tracking entries can be supported.

**Interface Tracking**

Track the status of each port or layer 3 interfaces.

**Ping Tracking**

Track the status of certain remote devices by IP address.

**Logic Tracking**

This function is a logic flow that can combine the interface tracking, ping tracking, and the logic tracking item with AND or OR logic.

**Tracking Function**

**Tracking Function**

Enable

[Apply](#)

Setting	Description	Factory default
Enable/Disable	Enable or disable the tracking feature	Disabled

**Interface Tracking**

**Interface Tracking**

Enable

Tracking ID

Interface Type  Port  Layer 3 Interface

Port

Interval (ms)

Up Delay (ms)  100,000 means the status does not change from down to up

Down Delay (ms)  100,000 means the status does not change from up to down

[Add](#)
[Delete](#)
[Modify](#)
[Apply](#)

<input type="checkbox"/> All	TID	Interface	Interval (ms)	Up Delay (ms)	Down Delay (ms)	Enable
<input type="checkbox"/>	1	Port 1	1000	1000	1000	Enable
<input type="checkbox"/>	2	Port 2-2	1000	1000	1000	Enable

**Enable**

Setting	Description	Factory default
Enable/Disable	Enable or disable the interface tracking entry	Enabled

**Tracking ID**

The tracking ID is the ID of the interface tracking entry. The tracking ID is unique in interface tracking, ping tracking, and logical tracking.

**Interface Type**

Setting	Description
Port	Track the port of the device

Layer 3 Interface	Track the interface of the device
-------------------	-----------------------------------

**Port/VLAN**

Choose the Port or VLAN that will be monitored.

**Interval**

Setting	Description	Factory default
Range: 100 to 100,000ms	The frequency to check the status of the monitored port or interface.	1000

**Up delay**

Setting	Description	Factory default
Range: 0 to 100,000ms	The status will change from down to up once the status of the monitored port or interface exceeds the delay time. If 100,000 ms is entered, the status will not change to up even if the monitored port/interface is up.	1000

**Down delay**

Setting	Description	Factory default
Range: 0 to 100,000ms	The status will change from up to down once the status of the monitored port or interface is less than the delay time. If 100,000 ms is entered, the status will not change to down even if the monitored port/interface is down.	1000

**Ping Tracking**

**Ping Tracking**

Enable

Tracking ID

IP Address

Interval (ms)

Timeout (ms)

Received  100 means the status does not change from lost to received

Lost  100 means the status does not change from received to lost

All	TID	IP Address	Interval (ms)	Timeout (ms)	Received	Lost	Enable
<input type="checkbox"/>	3	192.168.127.100	1000	100	3	3	Enable
<input type="checkbox"/>	4	192.168.127.120	1000	100	3	3	Enable

**Enable**

Setting	Description	Factory default
Enable/Disable	Enable or disable the interface tracking feature.	Enabled

**Tracking ID**

This is the ID of the ping tracking entry. The tracking ID is unique in interface tracking, ping tracking, and logical tracking.

**IP address**

The IP address that the user wants to monitor.

**Interval**

Setting	Description	Factory default
Range: 100 to 100,000 ms	The frequency to check the status of the monitored IP address.	1000

**Timeout**

Setting	Description	Factory default
Range: 1 to 100,000 ms	Specific period of time to determine that the ping request has no response.	100

**Received**

Setting	Description	Factory default
Range: 1 to 100 times	The status will change from down to up once the ping replies are greater or equal to the count. If 100 times is entered, the status will not change to up even if the condition is reached.	3

**Lost**

Setting	Description	Factory default
Range: 1 to 100 times	The status will change from up to down once lost the ping replies are greater or equal to the count. If 100 times is entered, the status will not change to down even if the condition is reached.	3

**Logical Tracking**

**Logical Tracking**

Enable

Tracking ID

Logical List

Logical Operator  NOT  AND  OR

All	TID	Logic List	Enable
<input type="checkbox"/>	3	[AND] TID 1, TID 1	Enable
<input type="checkbox"/>	4	[AND] TID 2, TID 3	Enable

**Enable**

Setting	Description	Factory default
Enable/Disable	Enable or disable the interface tracking feature.	Disabled

**Tracking ID**

This is the ID of the logical tracking entry. The tracking ID is unique in interface tracking, ping tracking, and logical tracking.

**Logic List**

Choose the Tracking ID that the user wants to put in the logic list; up to 4 tracking IDs are allowed.

**Logic Operator**

NOT is used to reverse the status of the logic tracking entry. If AND is chosen, then the status of the logical tracking entry will be up when all the status of the tracking entries are up. If OR is chosen, then any status of tracking id entries are up, the status of the logical tracking entry will be up.

**Tracking Table**

This table shows all of the information of the tracking entries.



### Tracking Table

All Tracking Page 1/1 2/64

TID	Type	Interface / IP Address / Logic List	Status	Time Since Last Change	No. of Change	Enable
1	Interface	Port 1	Down	0d0h7m29s	1	Enable
2	Interface	Port 2-2	Down	0d0h7m29s	1	Enable

VRRP and Static Routing can be modified by the triggered tracking entry.

**VRRP Settings**

### VRRP Settings

Enable VRRP Advertisement Interval (ms) 1000

Enable	Interface Name	IP Address	VID	Virtual IP	VRID	Priority	Preemption	VRRP Status / Cur Priority	TID	Decrement
<input checked="" type="checkbox"/>	vlan_2	192.168.2.1	2	192.168.2.253	2	100	<input checked="" type="checkbox"/>	Backup / 50	1	50
<input checked="" type="checkbox"/>	vlan_3	192.168.3.1	3	192.168.3.253	3	100	<input checked="" type="checkbox"/>	Master / 100	2	50

**Apply**

For detailed VRRP settings please refer to the VRRP section in the Layer 3 Routing user’s manual.

If the VRRP entry does not bind any tracking entry or the status of the bound tracking entry is “up”, the running VRRP priority would be equal to the VRRP priority configuration. If the VRRP entry binds a tracking entry and the status of the bound tracking entry is “down”, then the running VRRP priority would be (VRRP priority configuration minus decrement).

**TID:** The tracking entry ID can affect the VRRP entry.

**Decrement**

Settings	Description	Factory Default
Decrement (Range: 0 to 255)	This is the amount that will be reduced from the priority of the VRRP entry once the status of TID entry is down	0 (The value cannot be greater than the VRRP priority)

**Static Route Settings**

### Static Route

Destination Address: 192.168.210.0  
 Subnet Mask: 24(255.255.255.0)  
 Next Hop: 192.168.3.253  
 Metric (1~255): 10  
 Tracking ID: 1

All	Destination Address	Netmask	Next Hop	Metric	TID
<input type="checkbox"/>	192.168.200.0	255.255.255.0	192.168.2.253	10	N/A
<input type="checkbox"/>	192.168.210.0	255.255.255.0	192.168.3.253	10	1

For detailed Static Route settings please refer to the Static Routing section in the Layer 3 Routing user’s manual.

If the status of related TID entry is up, the routing address will remain at the routing table. If the status of TID entry is down, the routing address will be erased from the routing table.

**TID:** The tracking entry ID can affect the Static Route.

**Port Settings**

### Port Settings

Port	Enable	Media Type	Description	Speed	Flow Ctrl	MDI/MDIX	TID
1-1	<input checked="" type="checkbox"/>	1000TX,RJ45.	<input type="text"/>	Auto ▼	Disable ▼	Auto ▼	N/A ...
1-2	<input checked="" type="checkbox"/>	1000TX,RJ45.	<input type="text"/>	Auto ▼	Disable ▼	Auto ▼	N/A ...
1-3	<input checked="" type="checkbox"/>	1000TX,RJ45.	<input type="text"/>	Auto ▼	Disable ▼	Auto ▼	N/A ...
1-4	<input checked="" type="checkbox"/>	1000TX,RJ45.	<input type="text"/>	Auto ▼	Disable ▼	Auto ▼	N/A ...
2-1	<input checked="" type="checkbox"/>	1000TX,RJ45.	<input type="text"/>	Auto ▼	Disable ▼	Auto ▼	N/A ...
2-2	<input checked="" type="checkbox"/>	1000TX,RJ45.	<input type="text"/>	Auto ▼	Disable ▼	Auto ▼	N/A ...

Apply

For detailed port settings please refer to the port section settings.

If the status of related TID entry is up, the port will be enabled. If the status of TID entry is down, the port will be disabled. This can be observed in the page port status.

**TID:** The tracking entry ID can affect the port settings.

## Substation

### IEC 61850 QoS

GOOSE (Generic Object Oriented Substation Events) and SMV (Sampled Measured Values) play a key role in IEC 61850 substations. Once IEC 61850 QoS (Quality of Service) has been enabled, users can assign queuing priority for GOOSE and SMV packets to ensure they are always processed with a higher priority.

### IEC 61850 QoS

Enable IEC 61850 QoS

GOOSE High ▼

SMV Medium ▼

Note 1 : Packet types without QoS settings will be set as normal.

Note 2 : The IEC 61850 QoS provides higher priority queues for GOOSE/SMV packets than other packets. Once IEC 61850 QoS is enabled, the queuing mechanism of QoS classification will adapt the Strict mode.

Apply

**Enable IEC 61850 QoS**

Setting	Description	Factory Default
Enable/Disable IEC 61850 QoS	Enable or disable IEC 61850 QoS	Disable

**GOOSE**

Setting	Description	Factory Default
High, Medium, Normal, Low	The priority of the GOOSE message	High

**SMV**

Setting	Description	Factory Default
High, Medium, Normal, Low	The priority of the GOOSE message	Medium

## GOOSE Check

The switch can snoop the GOOSE messages passing through the switch and show the communication status of GOOSE messages on this page. The basic function will allow users to monitor if the GOOSE packets recorded in the monitoring list are consistent with the registered and valid GOOSE stream transmitted over the network. The user can manually change the GOOSE message entry type to static in order to keep a record of it in the monitoring list, even if the device reboots or reaches the maximum amount of messages that can be stored in the GOOSE Check page. The advanced function "GOOSE Lock", which is similar to GOOSE ACL (Access control list), will lock down the white-listing GOOSE packets shown in the monitoring table, and protect the network from unregistered or invalid GOOSE packets caused by incorrect operation. The advanced function also offers responses to GOOSE intrusion actions. If tampered GOOSE packets are detected, further responses such as dropping the tampered GOOSE packets can be selected to keep the GOOSE communications intact.

GOOSE Check maximum supports up to 100 GOOSE packets.

**GOOSE Check**

Enable Apply

**Advanced Function**

GOOSE Lock

Tamper Response N/A Apply

If GOOSE Lock is enabled, the GOOSE packets that are not shown in the monitoring table will be dropped.  
 If Tamper response is selected, the tampered GOOSE packets will be dropped via "drop" option or the ingress port of the tampered GOOSE packets will be disabled via "port disable" option.

**Add Static GOOSE Address**

APP ID 0x

GOOSE Address 01 - 0c - cd - 01 -  -  Apply

**Monitoring Table** Update Interval: every 5 secs

All	Index	APP ID	GOOSE Address	IED Name	VID	Ingress Port	Rx Counter	Status	Type
<input type="checkbox"/>	1	1	01:0c:cd:01:00:00	BC_CONTCTRL	1	1-2	85	Health	Static
<input type="checkbox"/>	2	1	01:0c:cd:01:00:01	BC_CONTCTRL	1	1-2	85	Health	Dynamic
<input type="checkbox"/>	3	1	01:0c:cd:01:00:02	BC_CONTCTRL	1	1-2	85	Timeout	Dynamic
<input type="checkbox"/>	4	1	01:0c:cd:01:00:03	BC_CONTCTRL	1	1-2	85	Health	Dynamic
<input type="checkbox"/>	5	1	01:0c:cd:01:00:04	BC_CONTCTRL	1	1-2	85	Health	Static
<input type="checkbox"/>	6	1	01:0c:cd:01:00:05	BC_CONTCTRL	1	1-2	85	Health	Dynamic
<input type="checkbox"/>	7	1	01:0c:cd:01:00:06	BC_CONTCTRL	1	1-2	85	Tampered	Static
<input type="checkbox"/>	8	1	01:0c:cd:01:00:07	BC_27_1CTRL	1	1-2	85	Health	Dynamic

**Enable GOOSE Check**

Setting	Description	Factory Default
Enable/Disable GOOSE Check	Enable or disable GOOSE Check	Enable

**Advanced function**

**Enable GOOSE lock**

Setting	Description	Factory default
Enable/Disable GOOSE Lock	When GOOSE Lock is enabled, the switch will not learn and forward any other new GOOSE packets except the GOOSE stream shown in the monitoring table. The function assists the GOOSE configuration integrity.  <i>NOTE: Please make sure the monitoring table has recorded all the desirable GOOSE streams subscribed in the IEDs before the function is enabled.</i>	Disable

**Tamper response**

Setting	Description	Factory default
Drop	If a tampering event is detected, the switch will drop the tampered packets	Disable
Port disable	If a tampering event is detected, the switch will disable the tampered Ethernet port.  <i>Note: Disabling the tampered port may affect the network communication of other protocols. Please verify the network topology before the function is enabled.</i>	Disable

**Add Static GOOSE Address**

**APP ID**

Setting	Description
0000 to ffff (Hex.)	GOOSE application identifier

**GOOSE Address**

Setting	Description
01-0C-CD-01-00-00 to 01-0C-CD-01-01-ff	Destination MAC address of ingress GOOSE message

**Monitoring Table**

Item	Description
APP ID	GOOSE application identifier of ingress GOOSE message

Item	Description
GOOSE Address	Destination MAC address of ingress GOOSE message
IED Name	IED name of ingress GOOSE message
VID	VLAN ID of ingress GOOSE message
Ingress Port	The ingress port of GOOSE message
Rx Counter	Packet counter of ingress GOOSE message
Status	The status of GOOSE message communication. Health: The communication status of the GOOSE message is normal. Timeout: The communication status of the GOOSE message is abnormal. This GOOSE message does not pass through the switch at the correct time. Tampered: The GOOSE message has been sent from an abnormal port. Please be aware that the packet may have been tampered with.
Type	The type of GOOSE communication status entry Static: The GOOSE message is selected to be on the GOOSE message communication monitoring list. The static type GOOSE packet will not be erased once the port link is down and the device is turned off. Dynamic: The GOOSE message is discovered by the switch automatically. The dynamic type GOOSE packet will be erased once the port link is down and the device is turned off.
Reset	Reset the Rx counter and the status of the selected GOOSE messages
Delete	Delete selected GOOSE message
Set Static	Set the communication status of the GOOSE message to static entry

## MMS server

As Moxa's PT-G7728/G7828 switches support the MMS protocol, MMS client (e.g. SCADA) is able to receive the data objects sent from the switch (MMS server), just as the SCADA does for IEDs. A built-in MMS (Manufacturing Message Specification) server allows Ethernet switches to be controlled, monitored, and managed via a Power SCADA system without the need for any additional network management software.



### Enable MMS

Setting	Description	Factory Default
Enable/Disable MMS	Enable or disable the MMS server	Enable

# MIB Groups

---

The Moxa switch comes with built-in SNMP (Simple Network Management Protocol) agent software that supports cold/warm start trap, line up/down trap, and RFC 1213 MIB-II.

The standard MIB groups that the Moxa switch supports are as follows:

## **MIB II.1—System Group**

sysORTable

## **MIB II.2—Interfaces Group**

ifTable

## **MIB II.4 – IP Group**

ipAddrTable

ipNetToMediaTable

IpGroup

IpBasicStatsGroup

IpStatsGroup

## **MIB II.5—ICMP Group**

IcmpGroup

IcmpInputStatus

IcmpOutputStats

## **MIB II.6—TCP Group**

tcpConnTable

TcpGroup

TcpStats

## **MIB II.7—UDP Group**

udpTable

UdpStats

## **MIB II.10—Transmission Group**

dot3

dot3StatsTable

## **MIB II.11—SNMP Group**

SnmpBasicGroup

SnmpInputStats

SnmpOutputStats

## **MIB II.17—dot1dBridge Group**

dot1dBase

dot1dBasePortTable

dot1dStp

dot1dStpPortTable

dot1dTp

dot1dTpFdbTable

dot1dTpPortTable

```

dot1dTpHCPortTable
dot1dTpPortOverflowTable
pBridgeMIB
dot1dExtBase
dot1dPriority
dot1dGarp
qBridgeMIB
dot1qBase
dot1qTp
dot1qFdbTable
dot1qTpPortTable
dot1qTpGroupTable
dot1qForwardUnregisteredTable
dot1qStatic
dot1qStaticUnicastTable
dot1qStaticMulticastTable
dot1qVlan
dot1qVlanCurrentTable
dot1qVlanStaticTable
dot1qPortVlanTable

```

The Moxa switch also provides a private MIB file, located in the file **Moxa-[switch's model name]-MIB.my** on the Moxa switch utility CD-ROM.

### Public Traps

- Cold Start
- Link Up
- Link Down
- Authentication Failure
- dot1dBridge New Root
- dot1dBridge Topology Changed

### Private Traps

- Configuration Changed
- Power On
- Power Off
- Traffic Overloaded
- Turbo Ring Topology Changed
- Turbo Ring Coupling Port Changed
- Turbo Ring Master Mismatch
- Module Insert or Remove
- PortLoopDetectedTrap
- RateLimitedOnTrap
- LLDPChgTrap
- ABC-02 error
- Account Authentication Success,
- Account Authentication Failure,
- Number of Mac Sticky Address is over the threshold
- Fiber Warning
- Event Log is over capacity
- Account Information Changed
- Configuration is imported
- Remote Authentication success
- Remote Authentication fail
- Status of tracking object is changed
- Tracking VRRP changed

- Tracking Static Route Change
- Tracking port enable change
- EPS on
- EPS off
- GOOSE Check
- Dying Gasp