

User Manual

BPC-3060-1A1

Fanless Embedded Box PC
with 4th Generation Intel® Core™ i5
Haswell Processor

Record of Revision

Version	Issued Date	Description	Owner
V1.0	2015.4.21	First Release	Jerry

Copyright

The documentation and the software included with this product are copyrighted 2014 by Arestech Co., Ltd. All rights are reserved. Arestech Co., Ltd. reserves the right to make improvements in the products described in this manual at any time without notice. No part of this manual may be reproduced, copied, translated or transmitted in any form or by any means without the prior written permission of Arestech Co., Ltd. Information provided in this manual is intended to be accurate and reliable. However, Arestech Co., Ltd. assumes no responsibility for its use, nor for any infringements of the rights of third parties, which may result from its use.

Acknowledgements

Intel and Pentium are trademarks of Intel Corporation.

Microsoft Windows and MS-DOS are registered trademarks of Microsoft Corp.

All other product names or trademarks are properties of their respective owners.

Product Warranty

Arestech warrants to you, the original purchaser, that each of its products will be free from defects in materials and workmanship for two years from the date of purchase. This warranty does not apply to any products which have been repaired or altered by persons other than repair personnel authorized by Arestech, or which have been subject to misuse, abuse, accident or improper installation. Arestech assumes no liability under the terms of this warranty as a consequence of such events. Because of Arestech's high quality-control standards and rigorous testing, most of our customers never need to use our repair service. If an Arestech product is defective, it will be repaired or replaced at no charge during the warranty period. For outof- warranty repairs, you will be billed according to the cost of replacement materials, service time and freight. Please consult your dealer for more details.

If you think you have a defective product, follow these steps:

1. Collect all the information about the problem encountered. (For example, CPU speed, Arestech products used, other hardware and software used, etc.) Note anything abnormal and list any onscreen messages you get when the problem occurs.
2. Call your dealer and describe the problem. Please have your manual, product, and any helpful information readily available.
3. If your product is diagnosed as defective, obtain an RMA (return merchandize authorization) number from your dealer. This allows us to process your return

more quickly.

4. Carefully pack the defective product, a fully-completed Repair and Replacement Order Card and a photocopy proof of purchase date (such as your sales receipt) in a shippable container. A product returned without proof of the purchase date is not eligible for warranty service.
5. Write the RMA number visibly on the outside of the package and ship it prepaid to your dealer.

Safety Instructions

1. Read these safety instructions carefully.
2. Keep this User Manual for later reference.
3. Disconnect this equipment from any AC outlet before cleaning. Use a damp cloth. Do not use liquid or spray detergents for cleaning.
4. For plug-in equipment, the power outlet socket must be located near the equipment and must be easily accessible.
5. Keep this equipment away from humidity.
6. Put this equipment on a reliable surface during installation. Dropping it or letting it fall may cause damage.
7. The openings on the enclosure are for air convection. Protect the equipment from overheating. **DO NOT COVER THE OPENINGS.**
8. Make sure the voltage of the power source is correct before connecting the equipment to the power outlet.
9. Position the power cord so that people cannot step on it. Do not place anything over the power cord.
10. All cautions and warnings on the equipment should be noted.
11. If the equipment is not used for a long time, disconnect it from the power source to avoid damage by transient overvoltage.
12. Never pour any liquid into an opening. This may cause fire or electrical shock.
13. Never open the equipment. For safety reasons, the equipment should be opened only by qualified service personnel.
 - If one of the following situations arises, get the equipment checked by service personnel:
 - The power cord or plug is damaged.
 - Liquid has penetrated into the equipment.
 - The equipment has been exposed to moisture.
 - The equipment does not work well, or you cannot get it to work according to the user's manual.
 - The equipment has been dropped and damaged.
 - The equipment has obvious signs of breakage.
14. **DO NOT LEAVE THIS EQUIPMENT IN AN ENVIRONMENT WHERE THE STORAGE TEMPERATURE MAY GO BELOW -20° C (-4° F) OR ABOVE 60° C (140° F). THIS COULD DAMAGE THE EQUIPMENT. THE EQUIPMENT SHOULD BE IN A CONTROLLED ENVIRONMENT.**
15. **CAUTION: DANGER OF EXPLOSION IF BATTERY IS INCORRECTLY**

REPLACED. REPLACE ONLY WITH THE SAME OR EQUIVALENT TYPE RECOMMENDED BY THE MANUFACTURER, DISCARD USED BATTERIES ACCORDING TO THE MANUFACTURER'S INSTRUCTIONS.

Safety Precaution - Static Electricity

Follow these simple precautions to protect yourself from harm and the products from damage.

- To avoid electrical shock, always disconnect the power from your PC chassis before you work on it. Don't touch any components on the CPU card or other cards while the PC is on.
- Disconnect power before making any configuration changes. The sudden rush of power as you connect a jumper or install a card may damage sensitive electronic components.

Contents

Chapter 1: General Introduction	1
1.1 Overview.....	2
1.2 Key Features.....	3
1.3 Hardware Specification.....	3
1.4 I/O Arrangement.....	5
1.5 Mechanical Dimension.....	12
Chapter 2: System Setup	13
2.1 Power Installation Procedure.....	13
2.2 Installing 2.5" HDD and swappable HDD Bracket.....	14
2.3 Installing Memory and Internal Expansion Device.....	16
2.4 Installing mini-PCIe and m-SATA Card.....	17
Chapter 3: BIOS Setting	18
3.1 Main.....	19
3.2 Advanced.....	20
3.2.1 CPU Configuration.....	21
3.2.2 Chipset Configuration.....	23
3.2.3 Storage Configuration.....	25
3.2.4 Intel(R) Rapid Start Technology.....	26
3.2.5 AMT Configuration.....	27
3.2.6 Super IO Configuration.....	29
3.2.6 ACPI Configuration.....	30
3.2.6 USB Configuration.....	32
3.2.6 Voltage Configuration.....	33
3.3 Hardware Health Event Monitoring Screen.....	34
3.4 Boot Screen.....	35
3.5 CSM(Compatibility Support Module).....	36
3.6 Security Screen.....	37
3.7 Exit Screen.....	38

Chapter1. General Introduction

1.1 Overview

The BPC-3060 is a high performance fanless Box PC with a 4th generation Intel® Core™ i5 Haswell processor conveniently housed within a compact enclosure. Though small in size, the BPC-3060 still provides rich I/O connectors, and supports up to four GbE ports with simultaneous high speed Ethernet communications. Additionally, the BPC-3060's three COM ports and one DIO port can make machine automation control or data collection easier. This high performance fanless Box PC is also ideal for video/graphics applications with dual HDMI 1.4a ports supporting up to 4096 x 2304 resolution. The fanless and rugged enclosure is designed to protect against electromagnetic interference and to suit various applications in the automation, digital signage, gaming, entertainment, medical, and networking markets.



(Front Cover/IO Cover)



(Heatsink)

1.2 Key Features

- Intel® Core™ i5-4300U Dual-Core 1.9 GHz
- Single Channel DDR3L 1333/1600 MHz SDRAM up to 8 GB
- 4 GbE, 4 USB 3.0, 3 COM,1(8bit DIO), 2 HDMI, Mic_in, Line_out
- Internal Expansion slot:
 - Mini-PCIe 1 (Half Size)
 - Mini-PCIe 1 (Full Size) shared with mSATA
 - mSAT 1 (Full Size) shared with SATA2
- 9~36 V DC Power Input
- -20~60° C Operating Temperature

1.3 Hardware Specification

Model		BPC-3060-1A1
Processor System	CPU	IBGA type for Intel® Core™ I5-4300U Haswell ULT Dual core MCP processor
	Frequency	1.9 GHz / 2.9 GHz (Boost), 2 Cores / 4 Threads
	Intel® Smart Cache	3 MB
	System Chipset	By CPU
	BIOS	UEFI
Memory	Technology	DDR3L 1333/1600 MHz SDRAM (1.35 V only)
	Max. Capacity	8GB
	Socket	1, 204-pin SO-DIMM
Display	Graphics Engine	Intel® HD Graphics 4400 with 200-1100 MHz Frequency
	VGA	NA
	HDMI	Supports HDMI 1.4a, supported with Level Shift, resolution up to 4096x2304 (1 x HDMI)
	Dual Display	2 HDMI
I/O Interface	USB	4 USB 3.0, 2 internal USB 2.0 (for Keypro)
	Serial Port	4 COM ports (2 x RS-232, 2 x RS-232/422/485)
	GPIO	8 GPIO (DP-9 Connector)
Ethernet	Controller	4 GbE 10/100/1000 Mbps
Audio	Chipset	Realtek ALC662 High Definition Audio(HD)
	Connector	Line out, Mic in

Expansion	Mini PCIe	Mini PCIe (Half Size)
Storage	SATA III	1 x 2.5" HDD/SSD bay (swappable)
	Power Type	AT /ATX
Power	Power Connector	2-pin Terminal Block
	Power Input	9-36 V DC-input, 9.3A - 2.3A
	Power Consumption	Typical: 12W @12V DC-input (w/o expansion cards) Full Load: 31W @ 12V DC-input (w/o expansion cards)
	Operational Temp	-20~60° C (-4~140° F) (Operational humidity: 60° C @ 95% RH Non-Condensing)
Environment	Non-Operational	-40~85° C and 60° C @ 95% RH Non-condensing
	Vibration	1 Grms, IEC 60068-2-64, random, 5~500 Hz, 1 Oct/min., 1hr/axis, x,y,z 3 axes
	Shock	20 G, IEC 60068-2-27, half sine, 11 ms duration
Certification	EMC	CE, FCC, LVD Class A
	Dimensions (W x H x D)	238 x55 x165 mm (9.37" x 2.16" x 6.5")
General	Weight	1.73 kg (3.81 lb)
	OS	Windows 7/8, WS7E/P, WES8, Linux kernel 2.6.x or above for Fedora, Yocto

1.4 I/O Arrangement

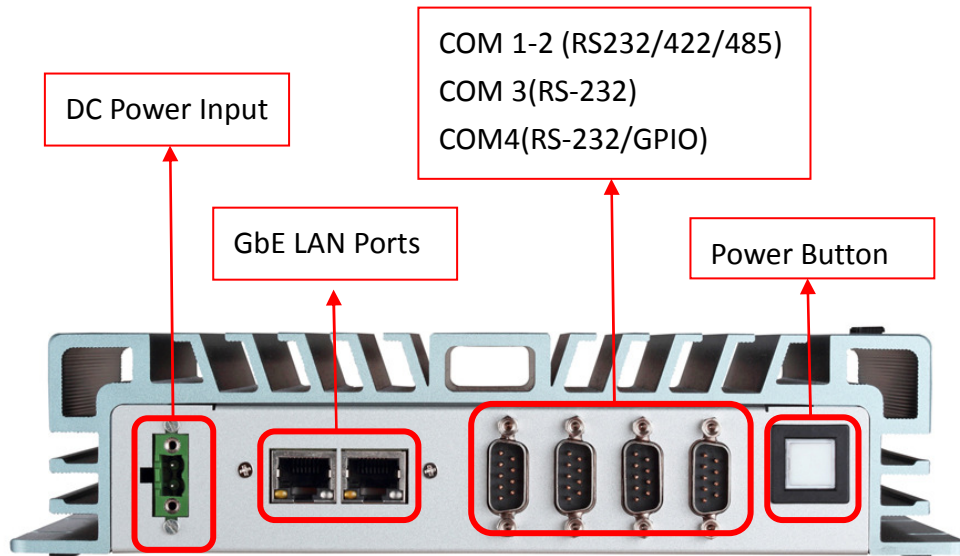
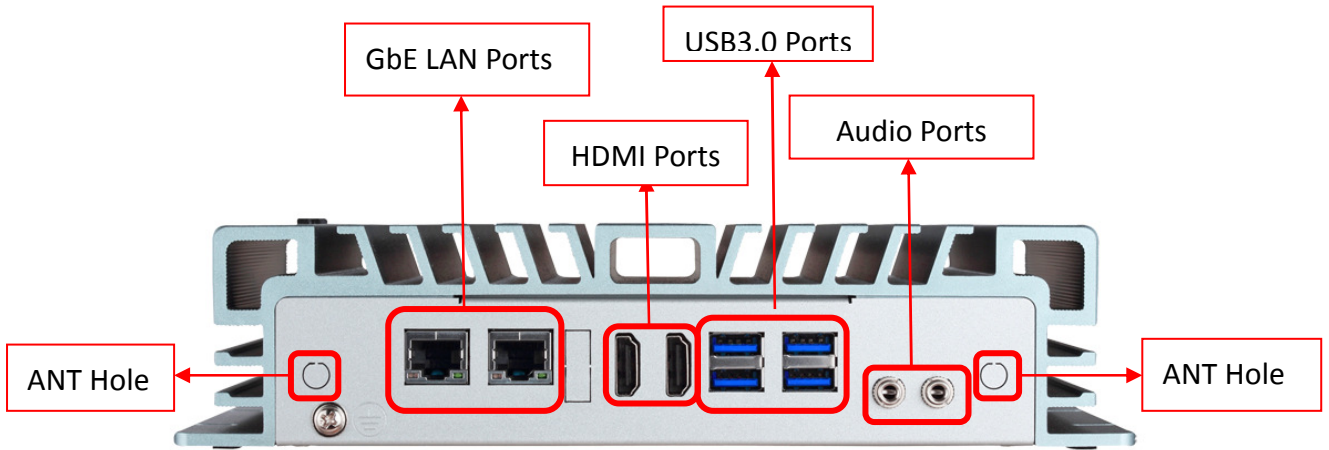

■ **Power Button**

Press this button to turn on the system.

■ **DC 9-36V Power Input Connector**

This System supports DC 9-36V input power voltage.

This connector must be connected to DC 9 to 36 V power adaptor.

After plugging phoenix connector , be sure to fasten the two screws to lock the connector.

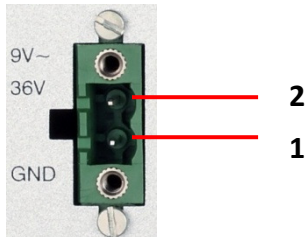

Pin	Definition
1	GND
2	Vin+ (9~36V DC)

■ **HDMI Port**

1. Supports HDMI 1.4a, supported with Level Shift, resolution up to 4096x2304 (1 x HDMI)

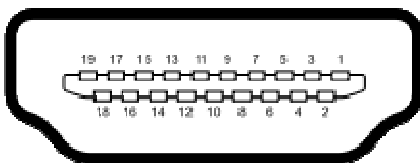

Pin	Definition	Pin	Definition
1	TMDS Data2+	2	TMDS Data2 Shield
3	TMDS Data2 -	4	TMDS Data1+
5	TMDS Data1 Shield	6	TMDS Data1-
7	TMDS Data0+	8	TMDS Data0 Shield
9	TMDS Data0-	10	TMDS Clock+
11	TMDS Clock Shield	12	TMDS Clock-
13	Reserved	14	Reserved
15	SCL	16	SDA
17	DDC Ground	18	+5 V Power
19	Hot Plug Detect		

■ LAN Port

This port can be connected to the Ethernet via RJ-45 connector .

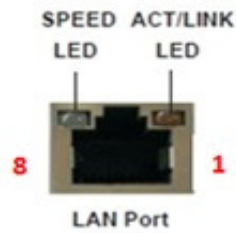

10/100BASE-T:

Pin	Definition	Pin	Definition
1	TX_D0+	5	NC
2	TX_D0-	6	RX_D1-
3	RX_D1+	7	NC
4	NC	8	NC

1000BASE-T:

Pin	Definition	Pin	Definition
1	TX_D0+	5	BI_D2-
2	TX_D0-	6	RX_D1-
3	RX_D1+	7	BI_D3+
4	BI_D2+	8	BI_D3-

Activity/Link LED	
Status	Description
Off	No Link
Blinking	Data Activity
On	Link

SPEED LED	
Status	Description
Off	10Mbps connection
Green	100Mbps connection
Orange	1Gbps connection

■ USB 3.0 Port

Pin	Definition
1	+5
2	USB-
3	USB+
4	GND
5	StdA_SSRX-
6	StdA_SSRX+
7	GND_DRAIN
8	StdA_SSTX-
9	StdA_SSTX+

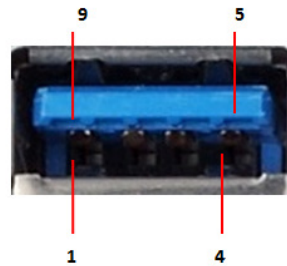

Basically, USB3.0 supports 900mA @ 5 V

■ COM 1-2 (RS-232/422/485)

Users can change the configuration of COM1 and COM2 by using BIOS setup utility.

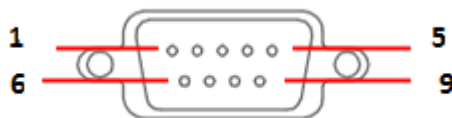

(RS-232)

Pin	Definition	Pin	Definition
1	DCD	6	DSR
2	RXD	7	RTS
3	TXD	8	CTS
4	DTR	9	NA/5V/12V
5	GND		

(RS-422)

Pin	Definition	Pin	Definition
1	TX-	6	N/A
2	RX+	7	N/A
3	TX+	8	N/A
4	RX-	9	N/A
5	GND		

(RS-485)

Pin	Definition	Pin	Definition
1	RTX-	6	N/A
2	N/A	7	N/A
3	RTX+	8	N/A
4	N/A	9	N/A
5	GND		

NOTE: Please refer to Chapter4 BIOS Setting - 3.2.6 Super IO Configuration COM1/2 Configuration (page) to set parameters of COM1/2

■ **COM 3-4 (RS-232 only)**

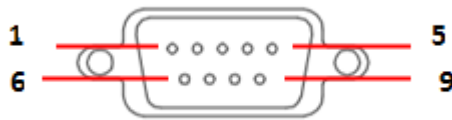

Pin	Definition	Pin	Definition
1	DCD	6	DSR
2	RXD	7	RTS
3	TXD	8	CTS
4	DTR	9	NA/5V/12V
5	GND		

■ **Audio Port**

Green connector means **LINE OUT** / Pink connector **MIC IN** .

■ **Digital I/O Ports (Optional)**



1	SIO_GP30	2	SIO_GP31
3	SIO_GP32	4	SIO_GP33
5	SIO_GP34	6	SIO_GP35
7	SIO_GP36	8	SIO_GP37
9	JGPIO_PWR		Outer Shielding

● **Guide:**

- DI ports have default high(3.3V) voltage.
Users have to input a low(GND) voltage to give a trigger signal.
- Users can define high(3.3V) or low(GND) voltage by themselves for

the output **DO** ports.

3. **VCC** port provides always DC high(5V) voltage.

4. **GND** port provide always DC low(GND) voltage.

■ Audio Port



LINE OUT / MIC IN .

■ ANT

It is a reserved hole for SMA connector of antenna.

If customer select a 3G or a WIFI module , he will need this ANT hole to plug a SMA connector.

Internal Interface:

■ SATA Connector:

(SATA3) connectors support SATA data cables for internal storage devices. The current SATA3 interface allows up to 6.0 Gb/s data transfer rate.



Pin	Definition
1	GND
2	TX+
3	TX-
4	GND
5	RX-
6	RX+
7	GND

■ SATA Power Connector:

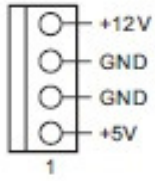

Pin	Definition
1	+5V
2	GND
3	GND
4	+12V

1.5 Mechanical Dimension

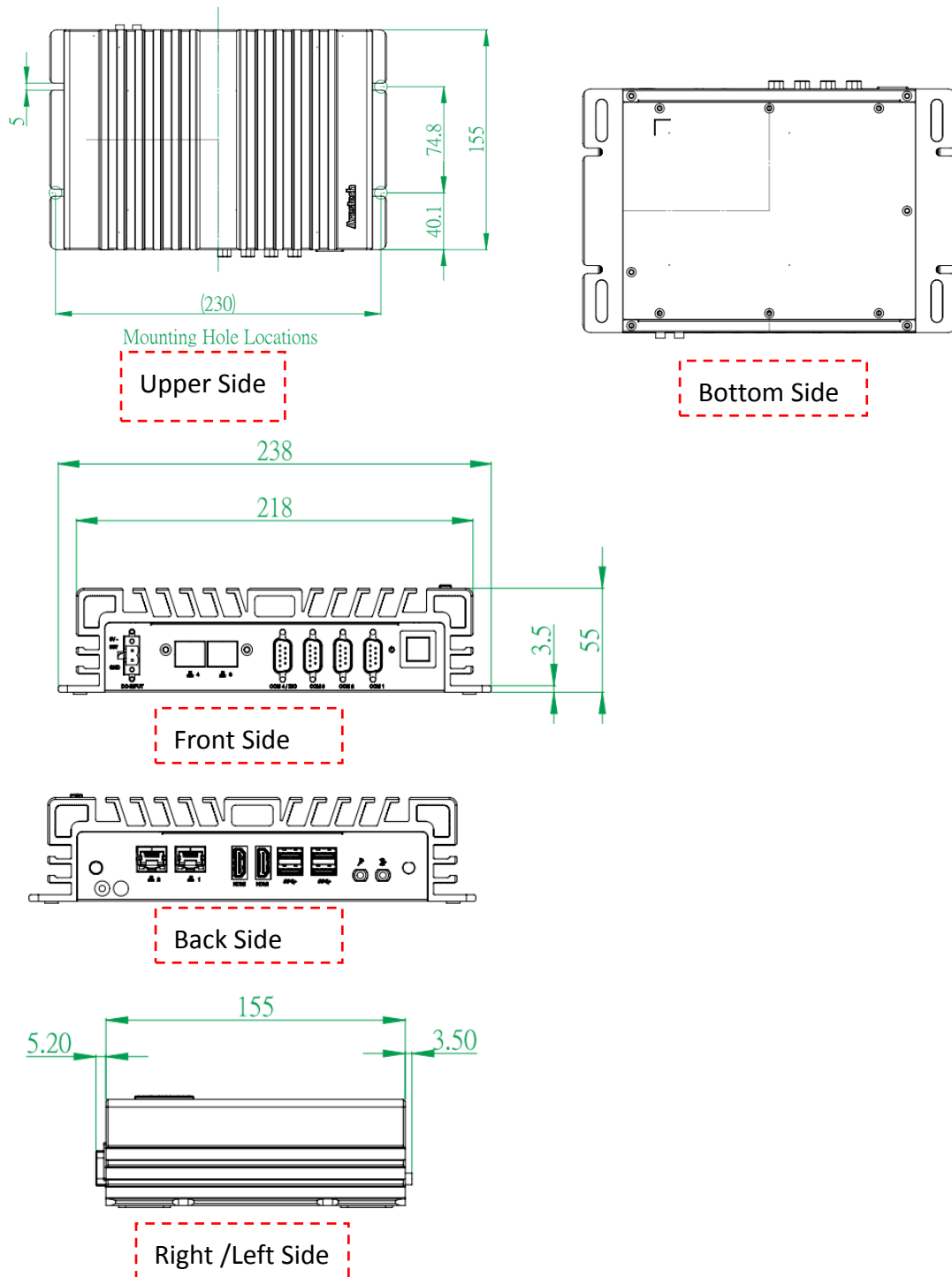

Chapter2. System Setup

2.1 Power Installation Procedure

1. Connecting Power Cord

The BOX-PC(BPC-3060) can support wide range DC-input (9~36V). Be sure to handle the power cord by holding the plug end only. Follow these procedures to connect the power cord:

- (1) Connect the male end(Phoenix connector) of the power cord to the DC-Input connector of BPC-3060 and lock it.
- (2) Connect the 3-pin male plug of the power cord to an electrical outlet.

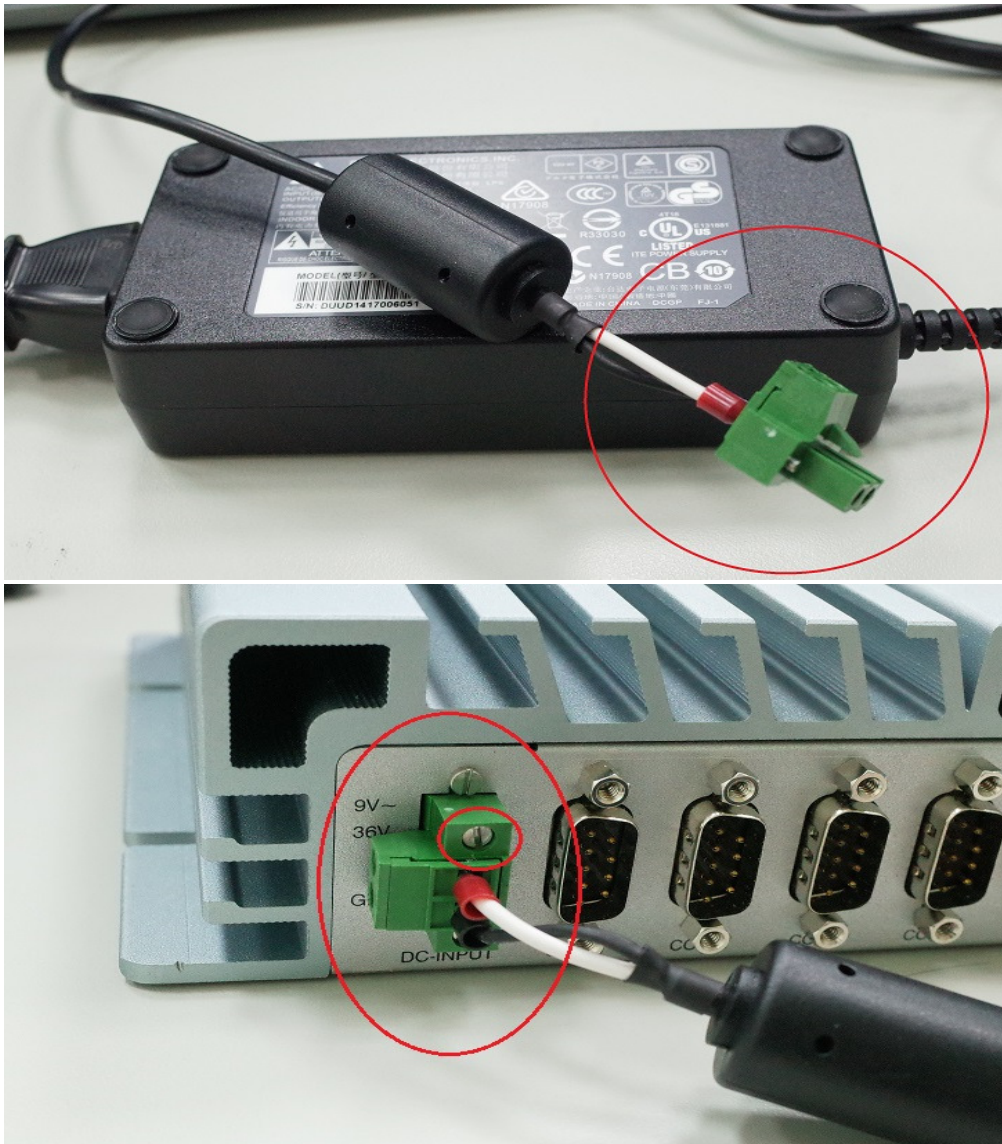

Step 3. Connect the **Phoenix Connector Terminal** into the system's **Power Input connector**.

**WARNING:**

1. After plugging phoenix connector , be sure to fasten the two screws to lock the connector.
2. White cable stands for 12V , black cable stand for GND. Make sure you plug connector in correct direction.

2.Connecting Keyboard and Mouse

Connect the mouse and keyboard to the USB connector of BPC-3030.

3. Switching on Power

The power button is located at the right side on the front cover of BPC-3030.

2.2 Installing 2.5" HDD and swappable HDD Bracket

1. Unfasten the 8 screws on the chassis and open the bottom cover.

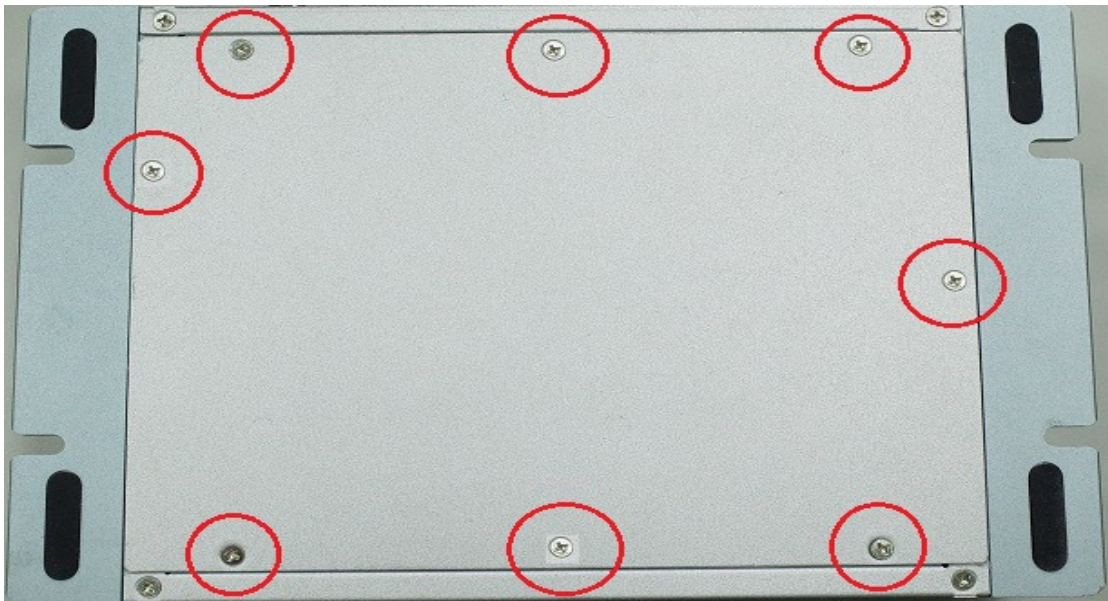

2. Unfasten the SATA cable and SATA power cable on the HDD/SSD



3. Unfasten the 4 screws on the HDD/SSD bracket.

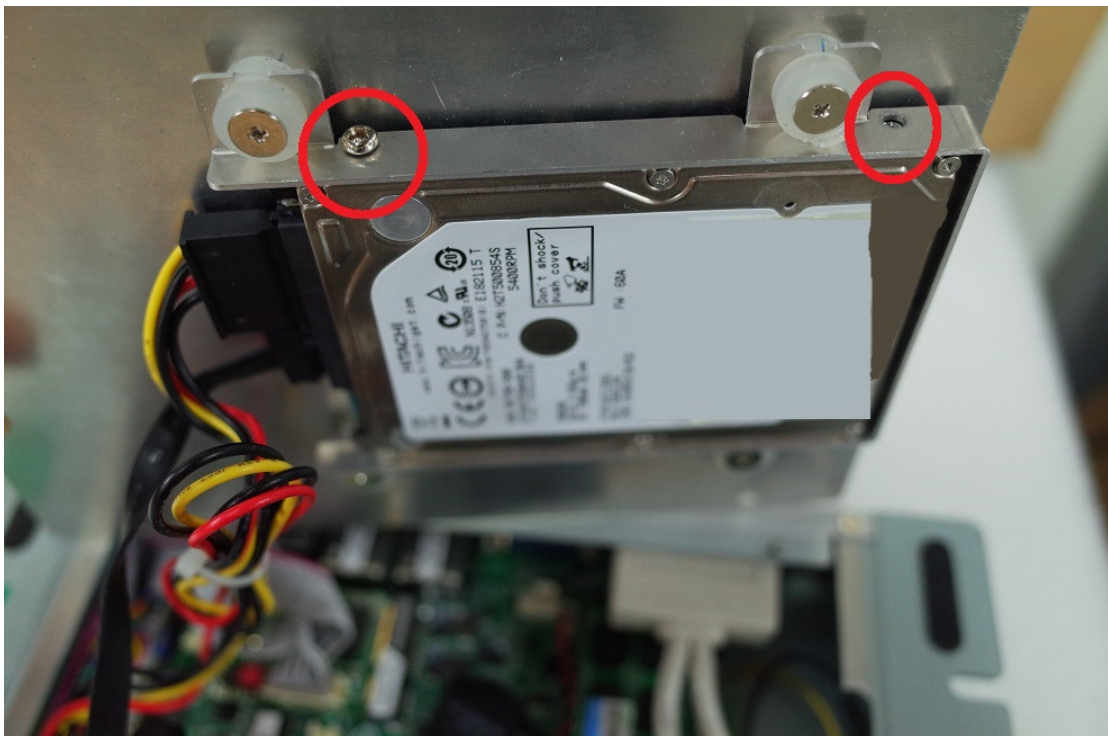

Notice that the bracket supports only 7mm and 9mm HDD/SSD.

2.3 Installing Memory and Internal Expansion Device

provides one 204-pin DDR3 (Double Data Rate 3) SO-DIMM slot, which supports single channel DDR3L SDRAM only.

Step 1. Align a SO-DIMM on the slot such that the notch on the SO-DIMM matches the break on the slot.

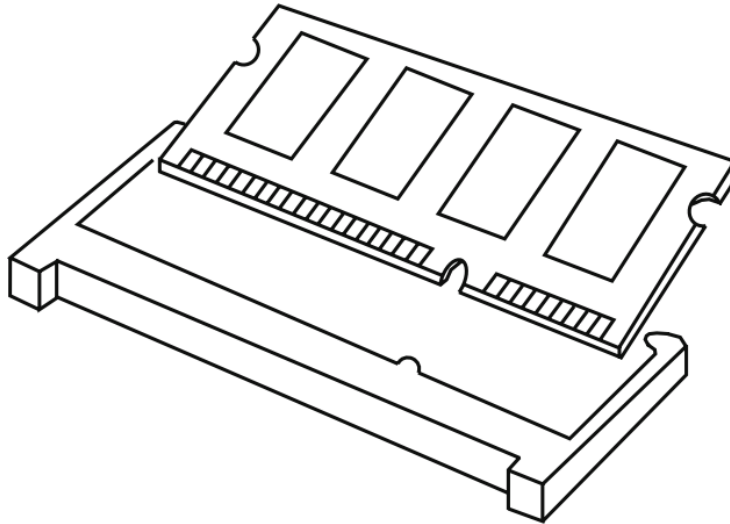

The SO-DIMM only fits in one correct orientation. It will cause permanent damage to the motherboard and the SO-DIMM if you force the SO-DIMM into the slot at incorrect orientation.

Step 2. Firmly insert the SO-DIMM into the slot until the retaining clips at both ends fully snap back in place and the SO-DIMM is properly seated.

2.4 Installing mini-PCIe Card and m-SATA Device

Expansion Slots (mini-PCIe and mini-PCIe/mini-SATA Slots)

There is 1 mini-PCIe slot and 1 mini-PCIe/mini-SATA slot on this motherboard.

mini-PCIe slot:

MINI_PCIE1 (mini-PCIe slot; half size) is used for PCI Express mini cards.

mini-PCIe/mini-SATA slot:

MINI_PCIE2 (mini-PCIe/mini-SATA slot; full size) is used for PCI Express mini cards or mSATA cards.



Installing an expansion card

Step 1.

Before installing the expansion card, please make sure that the power supply is switched off or the power cord is unplugged. Please read the documentation of the expansion card and make necessary hardware settings for the card before you start the installation.

Step 2.

Remove the system unit cover

Step 3.

Align the card connector with the slot and press firmly until the card is completely seated on the slot.

Step 4.

Fasten the card to the chassis with screws.

Step 5.

Replace the system cover.

Chapter 3. BIOS Setting

The BIOS (Basic Input/Output System) installed in your computer system's ROM supports Intel processors. The BIOS provides critical low-level support for a standard device such as disk drives, serial ports and parallel ports. It also adds virus and password protection as well as special support for detailed fine-tuning of the chipset controlling the entire system. The BIOS provides a Setup utility program for specifying the system configurations and settings. The BIOS ROM of the system stores the Setup utility.

When you turn on the computer, the BIOS is immediately activated. Pressing the key immediately allows you to enter the Setup utility.

When you enter the BIOS Setup utility, the top of the screen has a menu bar with the following selections:

- **Main** **To set up the system time/date information**
- **Advanced** **To set up the advanced UEFI features**
- **H/W Monitor** **To display current hardware status**
- **Security** **To set up the security features**
- **Boot** **To set up the default system device to locate and load the
Operating System**
- **Exit** **To exit the current screen or the UEFI SETUP UTILITY**

Use ← key or → key to choose among the selections on the menu bar.

Use <Enter> key to get into the sub screen or an item.

Use ↓ key or ↑ key to move cursor down or up to select items.

Use <Exit> key to exit current screen

3.1 Main

This section (Main screen) displays the system overview.

```

Aptio Setup Utility - Copyright (C) 2012 American Megatrends, Inc.
Main  Advanced  H/W Monitor  Boot  Security  Exit

UEFI Version      : SBC-310 L0.10
Processor Type    : Intel(R) Core(TM) i5-4300U CPU @ 1.90GHz
Processor Speed   : 1900MHz
Microcode Update  : 40651/10
Cache Size       : 3072KB

Total Memory      : 4096MB with 256MB Shared Memory
                  : and 2MB GTT memory
                  : Single-Channel Memory Mode

DDR3_A1          : 4096MB(DDR3-1600)

LVDS Rom Version : Default

System Date      : [Fri 02/06/2015]
System Time      : [18:10:09]

Set the Date. Use Tab to
switch between Date elements.

←→: Select Screen
↑↓: Select Item
Enter: Select
+/-: Change Option
F1: General Help
F7: Discard Changes
F9: Load UEFI Defaults
F10: Save and Exit
ESC: Exit

Version 2.15.1234. Copyright (C) 2012 American Megatrends, Inc.

```

3.2 Advanced

In this section, you may set the configurations for the following items: CPU Configuration, Chipset Configuration, Storage Configuration, Intel(R) Rapid Start Technology, AMT Configuration, Super IO Configuration, ACPI Configuration, USB Configuration and Voltage Configuration

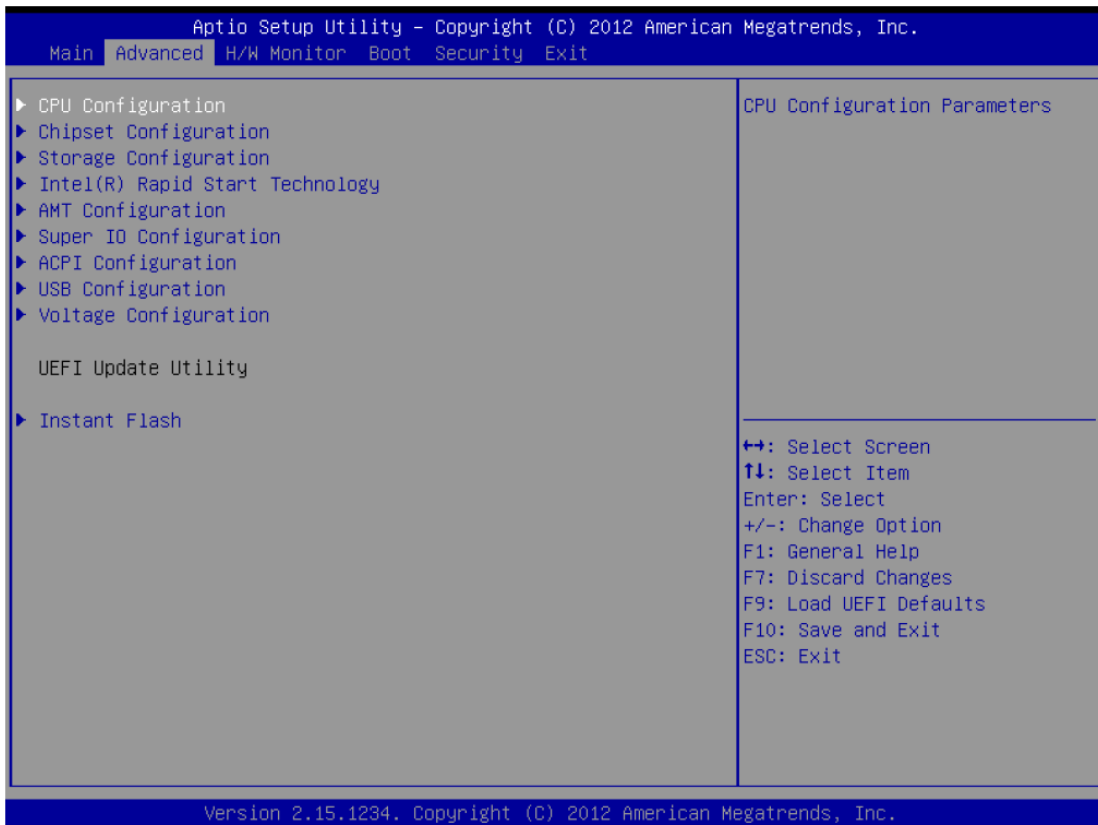

Instant Flash

Instant Flash is a UEFI flash utility embedded in Flash ROM. This convenient UEFI update tool allows you to update system UEFI without entering operating systems First like MS-DOS or Windows®. Just launch this tool and save the new UEFI file to your USB flash drive, floppy disk or hard drive, then you can update your UEFI only in a few clicks without preparing an additional floppy diskette or other complicated flash utility. Please be noted that the USB flash drive or hard drive must use FAT32/16/12 file system. If you execute Instant Flash utility, the utility will show the UEFI files and their respective information. Select the proper UEFI file to update your UEFI, and reboot your system after UEFI update process completes.

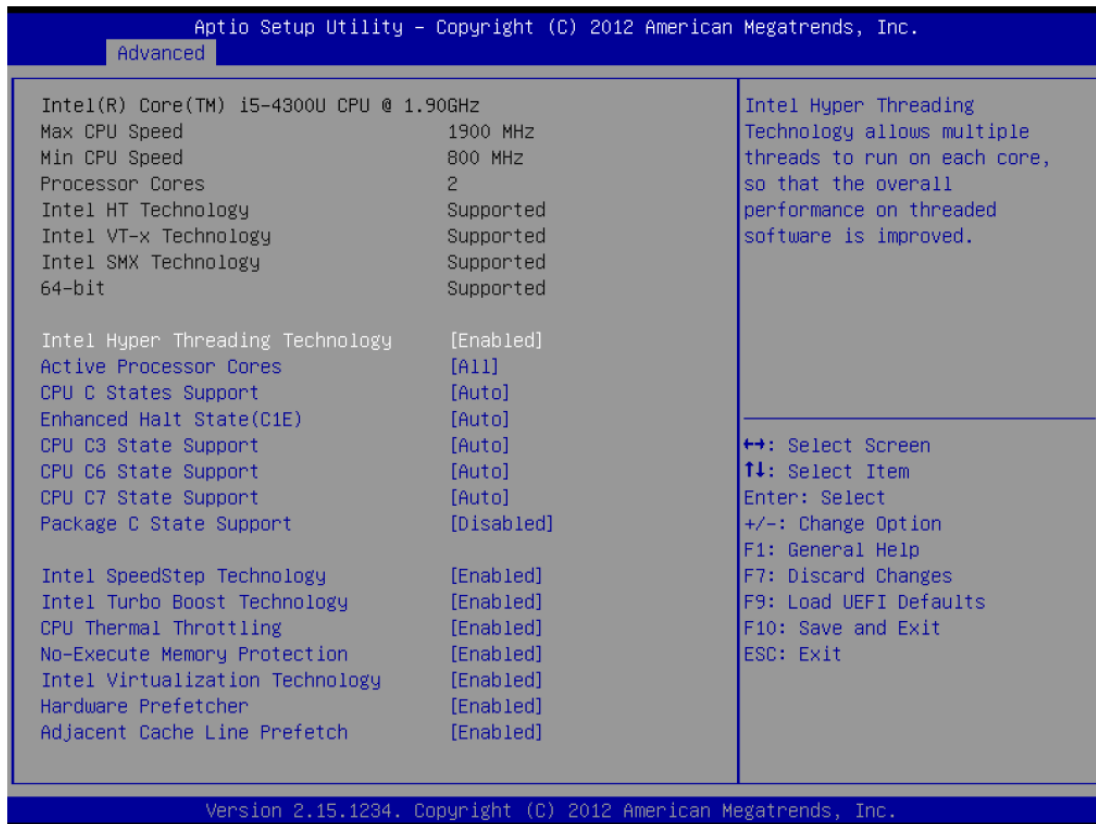

Intel Hyper Threading Technology

To enable this feature, a computer system with an Intel processor that supports Hyper-Threading technology and an operating system that includes optimization for this technology, such as Microsoft® Windows 7 / 8 is required. Set to [Enabled] if using Microsoft® Windows 7, 8, or Linux kernel version 2.4.18 or higher. This option will be hidden if the installed CPU does not support Hyper-Threading technology.

Active Processor Cores

Select the number of cores to enable in each processor package.

CPU C States Support

Enable CPU C States Support for power saving. It is recommended to keep C3, C6 and C7 all enabled for better power saving.

Enhanced Halt State (C1E)

Enable Enhanced Halt State (C1E) for lower power consumption.

CPU C3 State Support

Enable C3 sleep state for lower power consumption.

CPU C6 State Support

Enable C6 deep sleep state for lower power consumption.

CPU C7 State Support

Enable C7 deep sleep state for lower power consumption.

Package C State Support

Enable CPU, PCIe, Memory, Graphics C State Support for power saving.

Intel SpeedStep Technology

Intel SpeedStep technology is Intel's new power saving technology. Processors can switch between multiple frequencies and voltage points to enable power saving. The default value is [Enabled]. Configuration options: [Enabled] and [Disabled]. If you install Windows ® 7 / 8 and want to enable this function, please set this item to [Enabled]. This item will be hidden if the current CPU does not support Intel SpeedStep technology.



Please note that enabling this function may reduce CPU voltage and lead to system stability or compatibility issues with some power supplies. Please set this item to [Disabled] if above issues occur.

Intel Turbo Boost Technology

Use this item to enable or disable Intel Turbo Boost Mode Technology. Turbo Boost Mode allows processor cores to run faster than marked frequency in specific conditions. The default value is [Enabled].

CPU Thermal Throttling

You may select [Enabled] to enable CPU internal thermal control mechanism to keep the CPU from overheating.

No-Execute Memory Protection

No-Execution (NX) Memory Protection Technology is an enhancement to the IA-32 Intel Architecture. An IA-32 processor with "No Execute (NX) Memory Protection" can prevent data pages from being used by malicious software to execute codes. This option will be hidden if the current CPU does not support No-Execute Memory Protection.

Intel Virtualization Technology

When this option is set to [Enabled], a VMM (Virtual Machine Architecture) can utilize the additional hardware capabilities provided by Vanderpool Technology. This option will be hidden if the installed CPU does not support Intel Virtualization Technology.

Hardware Prefetcher

Use this item to turn on/off the MLC streamer prefetcher.

Adjacent Cache Line Prefetch

Use this item to turn on/off prefetching of adjacent cache lines.

3.2.2 Chipset Configuration

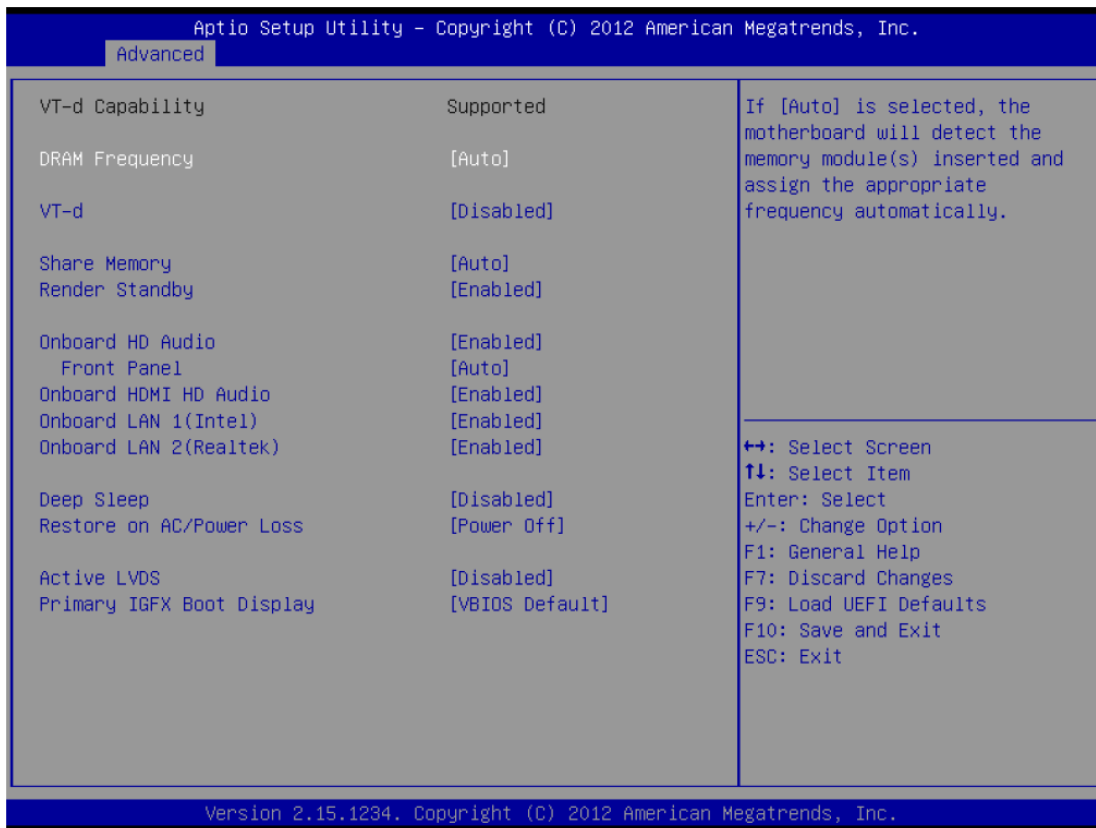

DRAM Frequency

If [Auto] is selected, the motherboard will detect the memory module(s) inserted and assign the appropriate frequency automatically.

VT-d

Intel® Virtualization Technology for Directed I/O helps your virtual machine monitor better utilize hardware by improving application compatibility and reliability, and providing additional levels of manageability, security, isolation, and I/O performance.

Share Memory

Configure the size of memory that is allocated to the integrated graphics processor when the system boots up.

Render Standby

Use this to enable or disable Render Standby by Internal Graphics Device. The default value is [Enabled].

Onboard HD Audio

Select [Auto], [Enabled] or [Disabled] for the onboard HD Audio feature. If you select [Auto].

Front Panel

Select [Auto] or [Disabled] for the onboard HD Audio Front Panel.

Onboard HDMI HD Audio

This allows you to enable or disable the Onboard HDMI HD Audio feature.

Onboard LAN 1 (Intel)

This allows you to enable or disable the Onboard LAN 1 feature.

Onboard LAN 2 (Realtek)

This allows you to enable or disable the Onboard LAN 2 feature.

Deep Sleep

Mobile platforms support Deep S4/S5 in DC only and desktop platforms support Deep S4/S5 in AC only. The default value is [Disabled].

Restore on AC/Power Loss

This allows you to set the power state after an unexpected AC/power loss.

If [Power Off] is selected, the AC/power remains off when the power recovers.

If [Power On] is selected, the AC/power resumes and the system starts to boot up when the power recovers.

If [LAST STATE] is selected, the AC/power restores to the last power state When the power recovers.

Active LVDS

Use this to enable or disable the LVDS. The default value is [Enabled].

Primary IGFX Boot Display

Use this to select primary internal graphics boot display. The default value is BIOS Default].

3.2.3 Storage Configuration

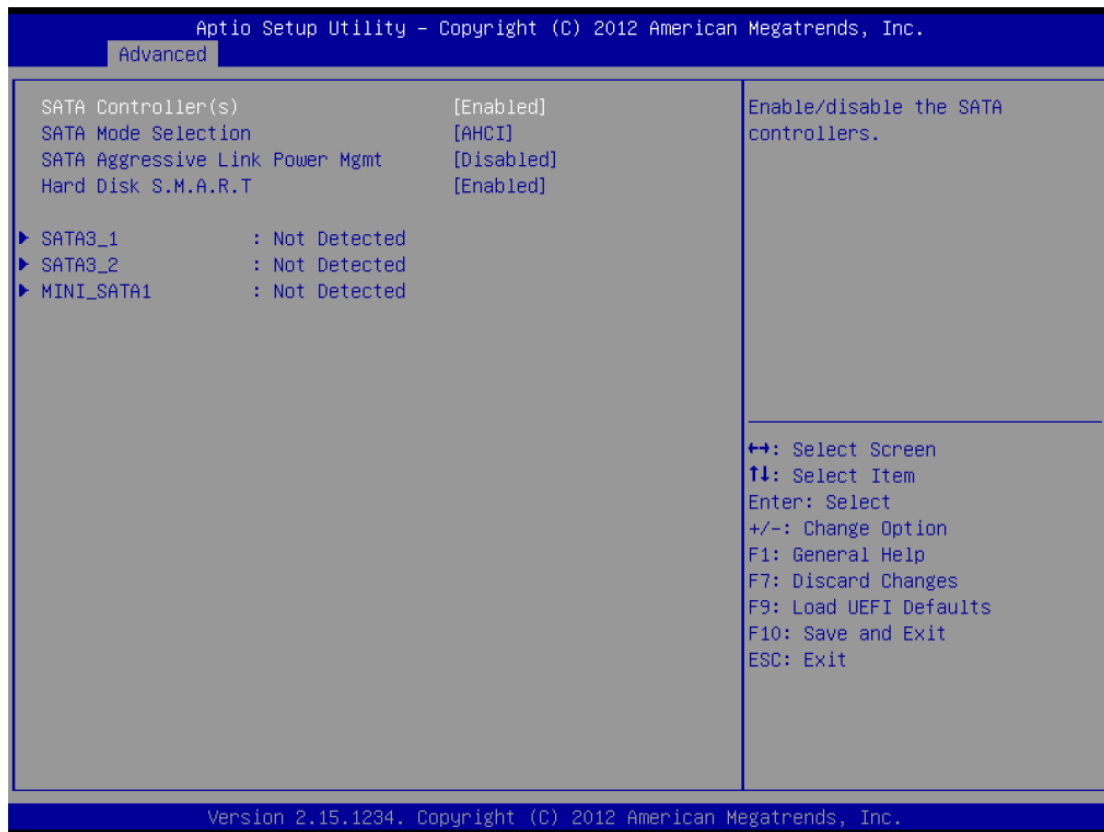

SATA Controller(s)

Use this item to enable or disable the SATA Controller feature.

SATA Mode Selection

Use this to select SATA mode. Configuration options: [IDE Mode] and [AHCI Mode]. The default value is [AHCI Mode].



AHCI (Advanced Host Controller Interface) supports NCQ and other new features that will improve SATA disk performance but IDE mode does not have these advantages.

SATA Aggressive Link Power Management

Use this item to configure SATA Aggressive Link Power Management.

Hard Disk S.M.A.R.T.

Use this item to enable or disable the S.M.A.R.T. (Self-Monitoring, Analysis, and Reporting Technology) feature. Configuration options: [Disabled] and [Enabled].

3.2.4 Intel(R) Rapid Start Technology



Intel(R) Rapid Start Technology

Use this item to enable or disable Intel(R) Rapid Start Technology. Intel(R) Rapid Start Technology is a new zero power hibernation mode which allows users to resume in just 5-6 seconds. The default is [Disabled].

3.2.5 AMT Configuration

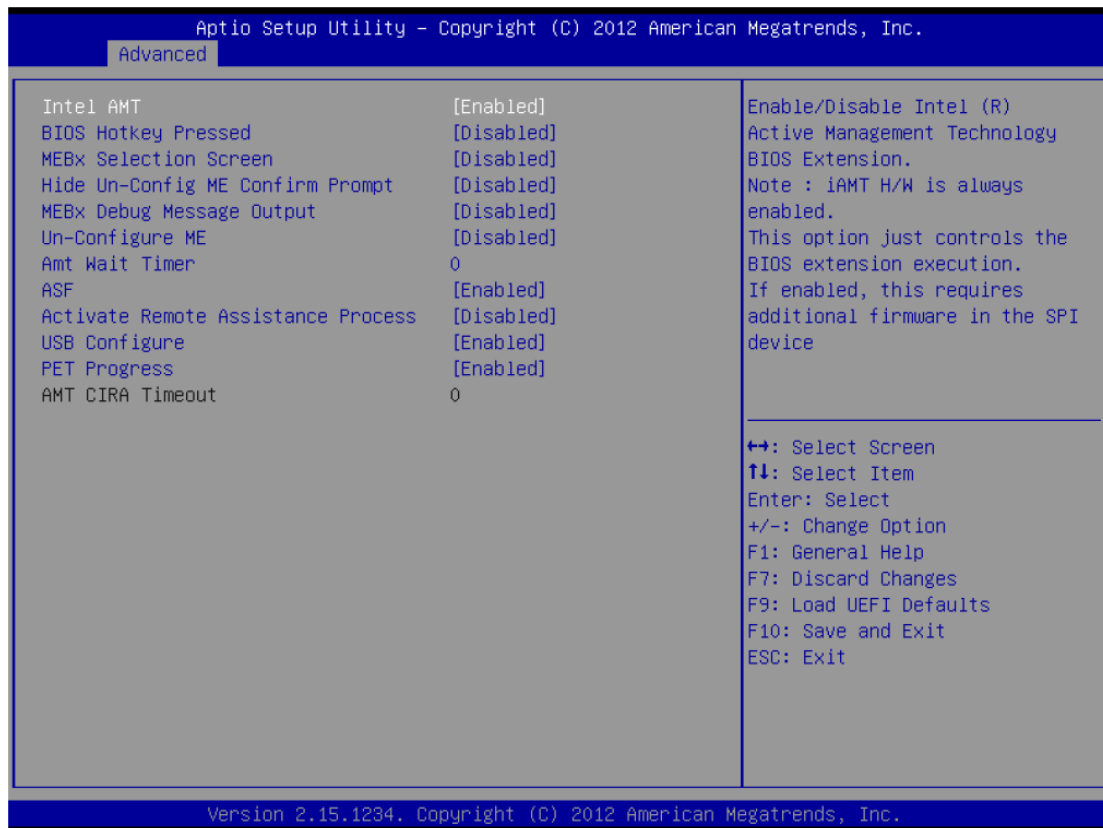

Intel AMT

Use this to enable or disable Intel(R) Active Management Technology.

BIOS Hotkey Pressed

Use this to enable or disable BIOS Hotkey Pressed.

MEBx Selection Screen

Use this to enable or disable MEBx selection screen.

Hide Un-Configure ME Configuration

Use this to hide Un-Configure ME without password confirmation prompt.

MEBx Debug Message Output

Use this to enable or disable MEBx debug message output.

Un-Configure ME

Use this to enable or disable Un-Configure ME without password.

AMT Wait Timer

Set timer to wait before sending ASF_GET_BOOT_OPTIONS.

ASF

Use this to enable or disable Alert Specification Format.

Activate Remote Assistance Process

Use this to enable or disable trigger CIRA boot.

USB Conigure

Use this to enable or disable USB Conigure.

PET Progress

Use this to enable or disable PET Events progress to recieve PET events.

3.2.6 Super IO Configuration



COM1 Coniguration

Use this to set parameters of COM1. Select COM1 port type:[RS232], [RS422] or [RS485].

COM2 Coniguration

Use this to set parameters of COM2. Select COM2 port type:[RS232], [RS422] or [RS485].

COM3 Coniguration

Use this to set parameters of COM3.

COM4 Coniguration

Use this to set parameters of COM4.

WDT Timeout Reset

This allows users to enable/disable the Watch Dog Timer timeout to reset system. The default value is [Disabled].

3.2.7 ACPI Configuration

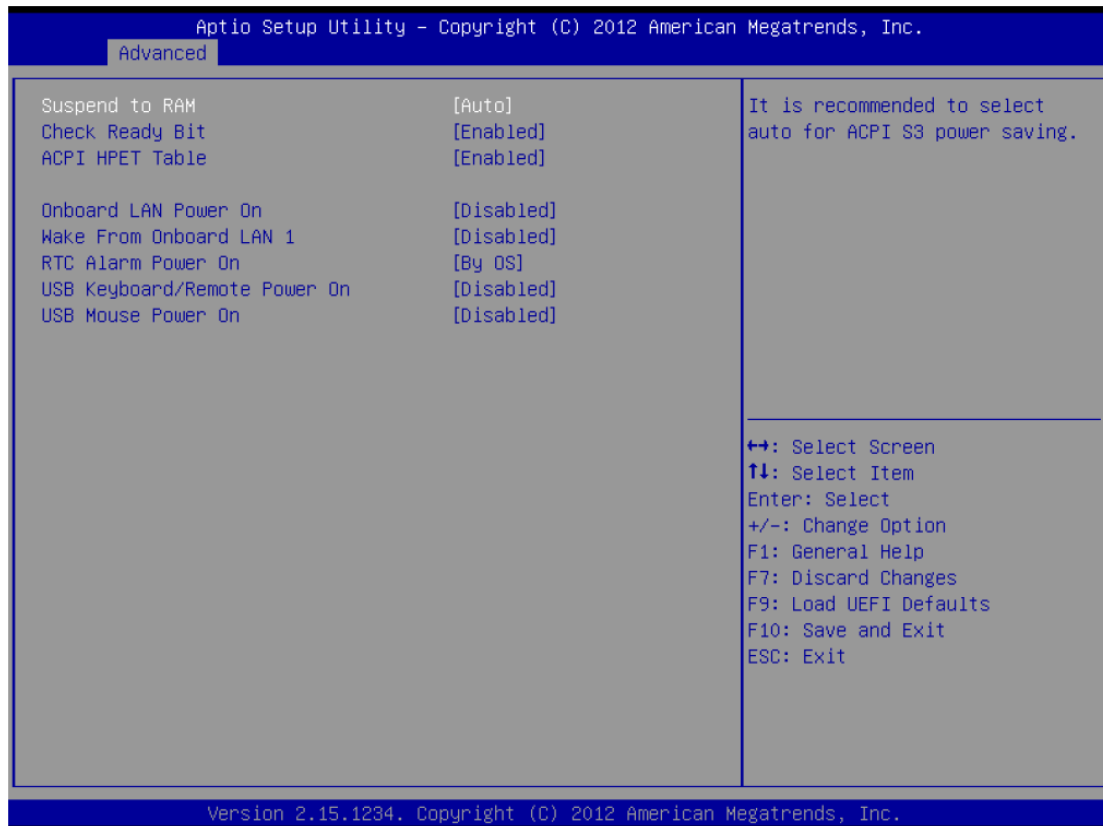

Suspend to RAM

Use this item to select whether to auto-detect or disable the Suspend-to-RAM feature. Select [Auto] will enable this feature if the OS supports it.

ACPI HPET Table

Use this item to enable or disable ACPI HPET Table. The default value is [Enabled]. Please set this option to [Enabled] if you plan to use this motherboard to submit Windows® certification.

Onboard LAN Power On

Use this item to enable or disable onboard LAN to turn on the system from the power-soft-off mode.

Wake From Onboard LAN 1

Use this item to enable or disable the Wake From Onboard LAN 1 feature.

RTC Alarm Power On

Use this item to enable or disable RTC (Real Time Clock) to power on the system.

USB Keyboard/Remote Power On

Use this item to enable or disable USB Keyboard/Remote to power on the system.

USB Mouse Power On

Use this item to enable or disable USB Mouse to power on the system.

3.2.8 USB Configuration



USB Controller

Use this item to enable or disable the use of USB controller.

Intel USB 3.0 Mode

Use this item to enable or disable the use of Intel USB 3.0 mode.

Legacy USB Support

Use this option to select legacy support for USB devices. There are four configuration options: [Enabled], [Auto] and [UEFI Setup Only]. The default value is [Auto]. Please refer to below descriptions for the details of these four options:

[Enabled] - Enables support for legacy USB.

[Auto] - Enables legacy support if USB devices are connected.

[UEFI Setup Only] - USB devices are allowed to use only under UEFI setup and Windows / Linux OS.

Legacy USB 3.0 Support

Use this option to enable or disable legacy support for USB 3.0 devices. The default value is [Enabled].

3.2.9 Voltage Configuration

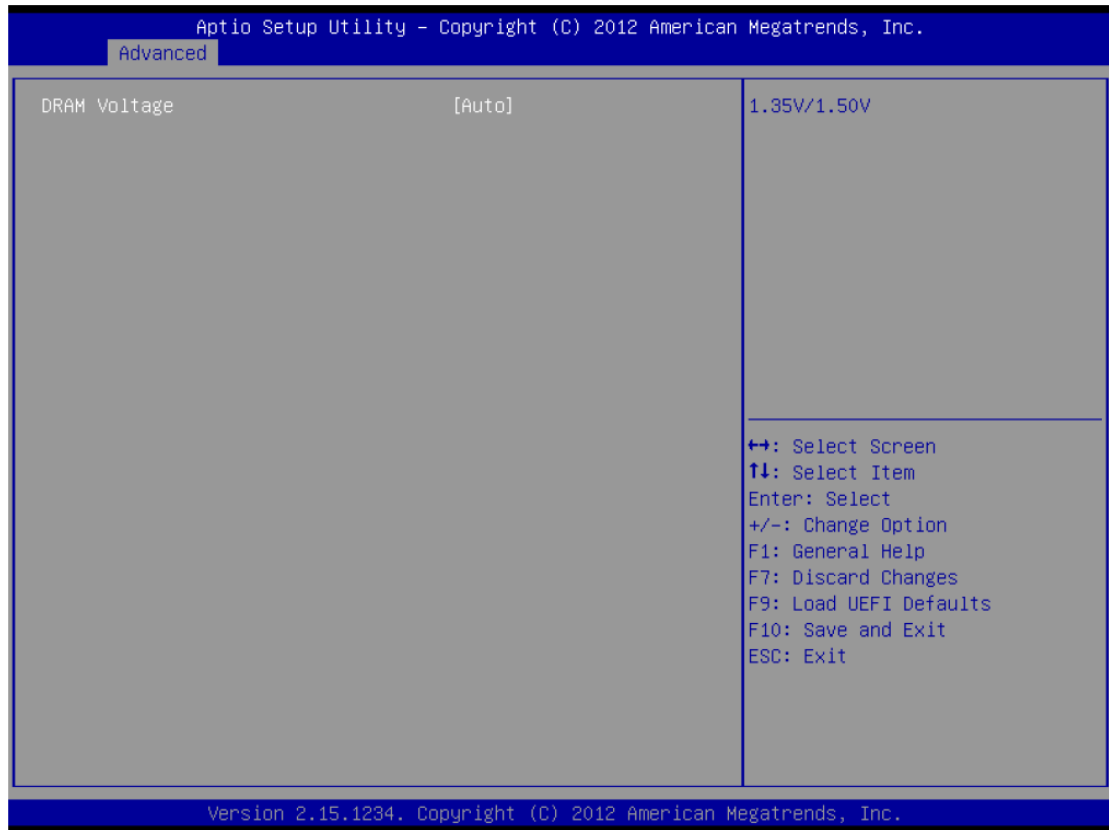

DRAM Voltage

Use this to select DRAM Voltage. The default value is [Auto].

3.3 Hardware Health Event Monitoring Screen

In this section, it allows you to monitor the status of the hardware on your system, including the parameters of the CPU temperature, motherboard Temperature, CPU, fan speed, chassis fan speed, and the critical voltage.

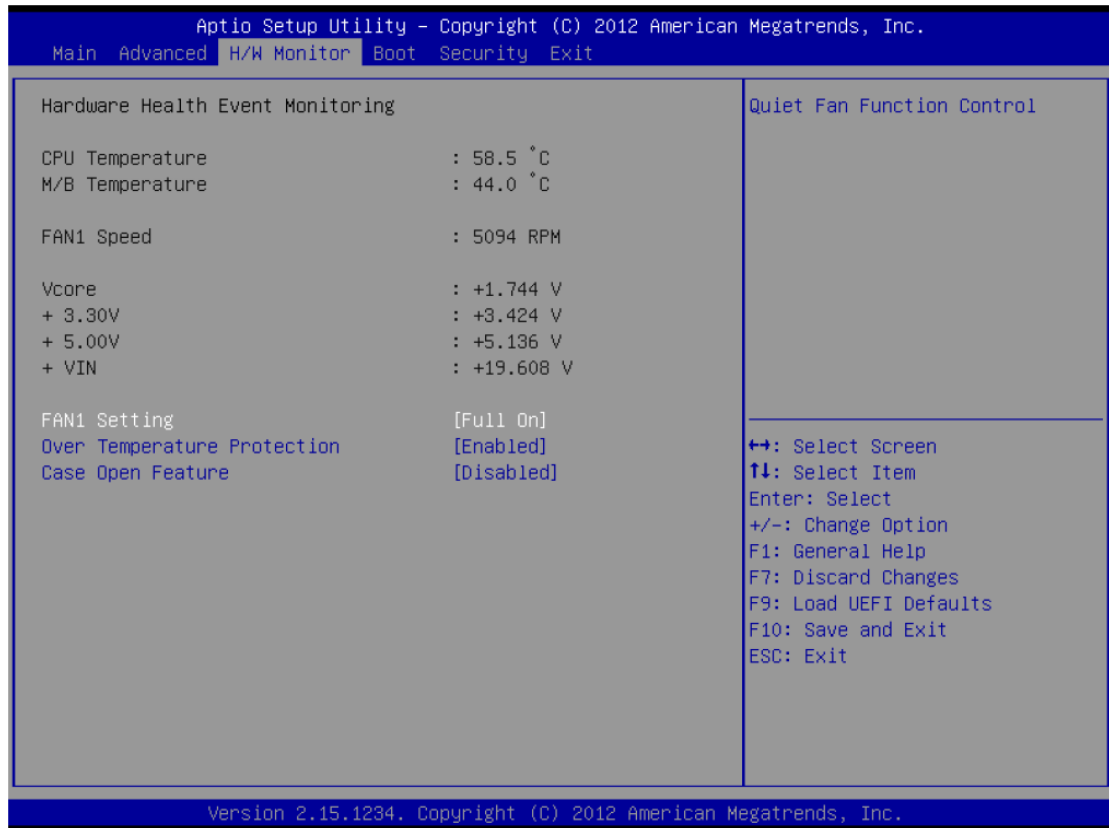

FAN1 Setting

This allows you to set fan 1's speed. Configuration options: [Full On] and [Automatic Mode]. The default value is [Full On].

Over Temperature Protection

Use this to enable or disable Over Temperature Protection. The default value is [Enabled].

Case Open Feature

This allows you to enable or disable case open detection feature. The default is value [Disabled].

Clear Status

This option appears only when the case open has been detected. Use this option to keep or clear the record of previous chassis intrusion status.

3.4 Boot Screen

In this section, it will display the available devices on your system for you to configure the boot settings and the boot priority.

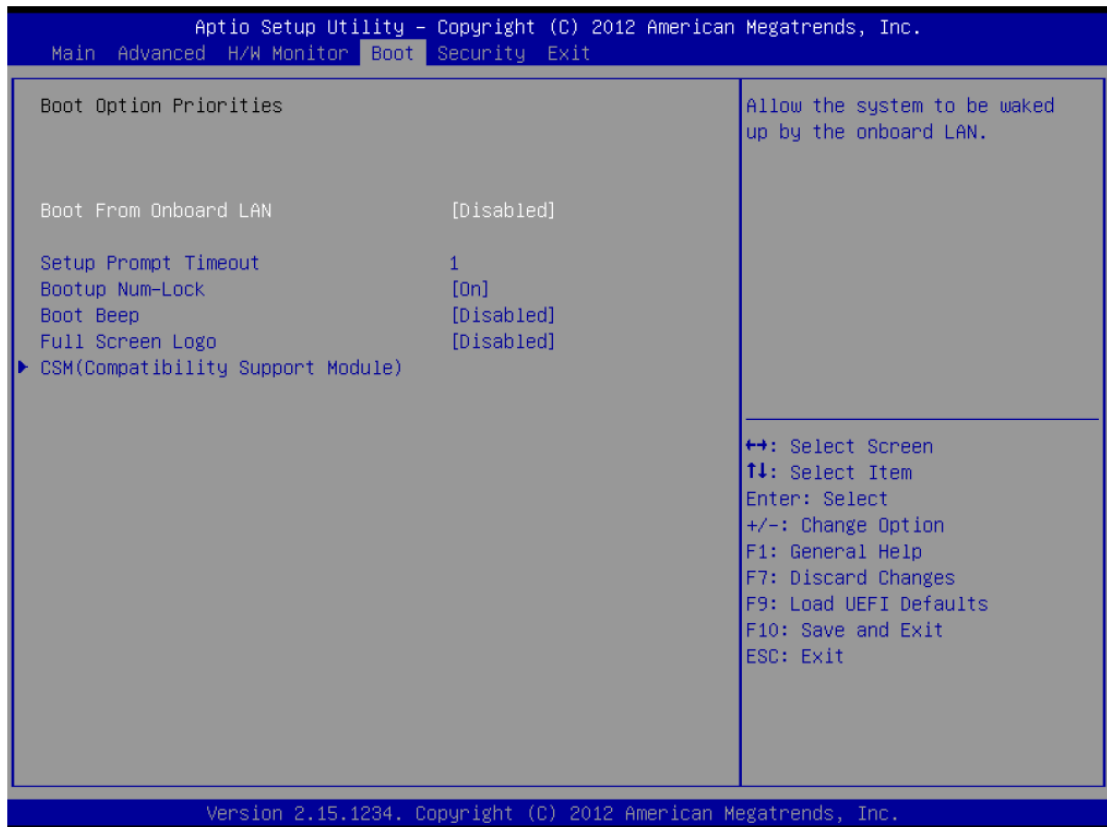

Boot From Onboard LAN

Use this item to enable or disable the Boot From Onboard LAN feature. Setup Prompt Timeout This shows the number of seconds to wait for setup activation key. 65535(0XFFFF) means indefinite waiting.

Bootup Num-Lock

If this item is set to [On], it will automatically activate the Numeric Lock function after boot-up.

Boot Beep

Select whether the Boot Beep should be turned on or off when the system boots up. Please note that a buzzer is needed.

Full Screen Logo

Use this item to enable or disable OEM Logo. The default value is [Disabled].

3.5 CSM (Compatibility Support Module)

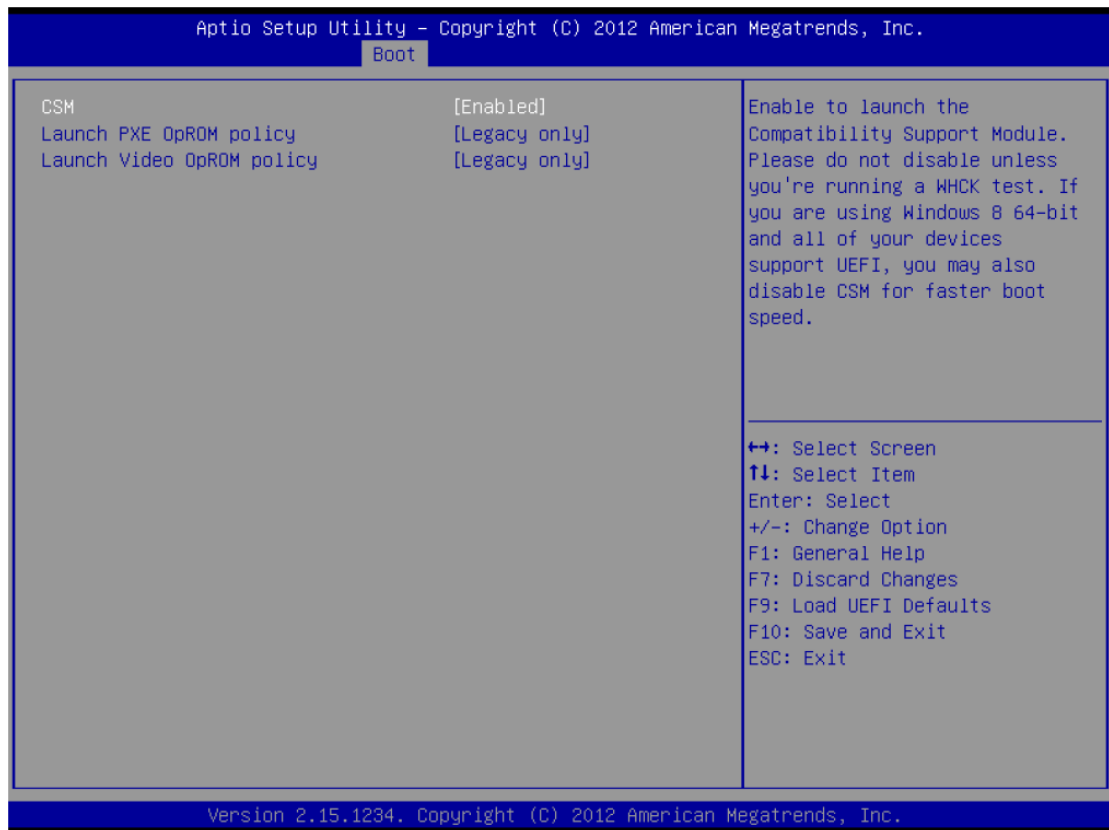

CSM

Enable to launch the Compatibility Support Module. Please do not disable unless you're running a WHCK test. If you are using Windows® 8 64-bit and all of your devices support UEFI, you may also disable CSM for faster boot speed.

Launch PXE OpROM Policy

Select UEFI only to run those that support UEFI option ROM only. Select Legacy only to run those that support legacy option ROM only. Do not launch?

Launch Video OpROM Policy

Select UEFI only to run those that support UEFI option ROM only. Select Legacy only to run those that support legacy option ROM only. Do not launch?

3.6 Security Screen

In this section, you may set, change or clear the supervisor/user password for the system.

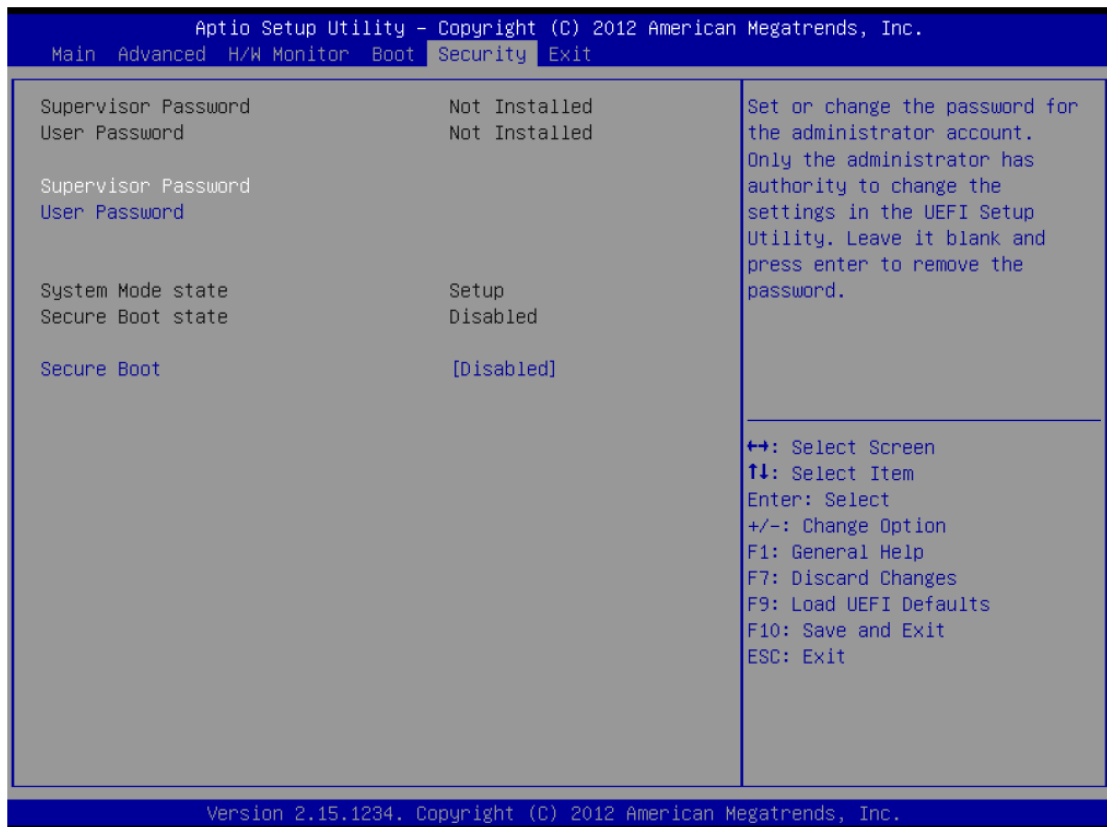

Supervisor Password

Set or change the password for the administrator account. Only the administrator has authority to change the settings in the UEFI Setup Utility. Leave it blank and press enter to remove the password.

User Password

Set or change the password for the user account. Users are unable to change the settings in the UEFI Setup Utility. Leave it blank and press enter to remove the password.

Secure Boot

Enable to support Windows 8 Secure Boot.

3.7 Exit Screen

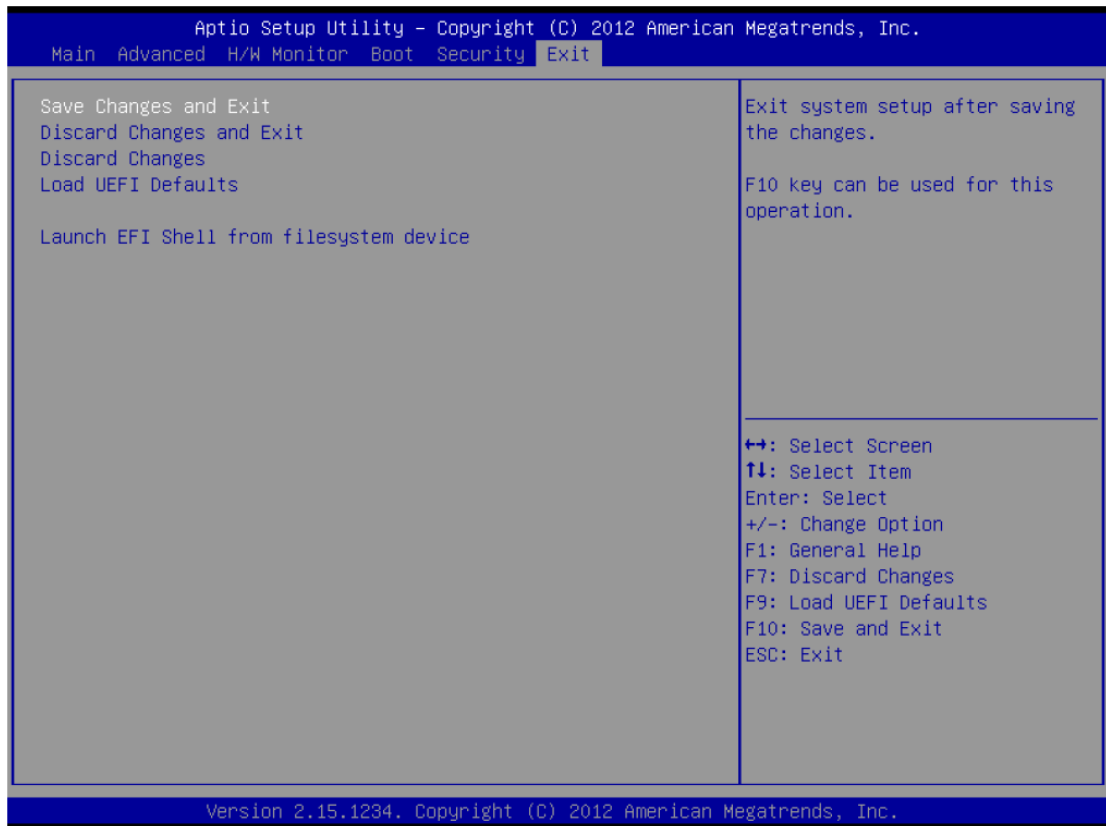

Save Changes and Exit

When you select this option, it will pop-out the following message, “Save configuration changes and exit setup?” Select [OK] to save the changes and exit the UEFI SETUP UTILITY.

Discard Changes and Exit

When you select this option, it will pop-out the following message, “Discard changes and exit setup?” Select [OK] to exit the UEFI SETUP UTILITY without saving any changes.

Discard Changes

When you select this option, it will pop-out the following message, “Discard changes?” Select [OK] to discard all changes.

Load UEFI Defaults

Load UEFI default values for all the setup questions. F9 key can be used for this operation.

Launch EFI Shell from filesystem device

Attempts to Launch EFI Shell application (Shell64.efi) from one of the available filesystem devices.

About Arestech

Arestech, founded in 2011, employs a highly talented R&D team with over a decade of product development experience in intelligent embedded computing.

With our dynamic expertise in the embedded market, Arestech offers a full range of intelligent systems, including embedded Box PCs, industrial multi-touch displays and multi-touch Panel PCs.

Arestech's dedication to product development is matched by its commitment to world class customer support with a minimum 5-year product lifecycle plan, product longevity, and added value for our partners.

Additionally, Arestech strategically aligns itself with key industry software and system integration partners to deliver top-notch design services and turnkey solutions, enabling our partners to better build and grow their businesses.

Arestech Headquarters

4F., No.53, Xingai Rd., Neihu Dist., Taipei City
114, Taiwan (R.O.C)
Tel : +886-2-2790-1930
Fax : +886-2-2790-1936
www.arestech.com.tw