

UST210-83K-FL NEW

Robust and Compact DIN-rail Fanless Embedded System with Intel® Atom® x5-E3940 Processor for In-Vehicle Gateway Application

Features

- CE, FCC certified; ISO 7637-2 compliant
- Intel® Atom® x5-E3940 processor
- Extreme cost-effective with fanless and cableless design
- Wide operating temperature range from -40°C to +70°C
- Supports 9-36 VDC & 12/24 VDC typical in-vehicle power input
- Smart Ignition for power on/off schedule, vehicle battery protection and different power mode
- Support COM, CAN, USB, GbE PoE LAN
- 8-bit programmable DIO
- Supports SocketCAN
- AMS.AXView intelligent remote monitoring

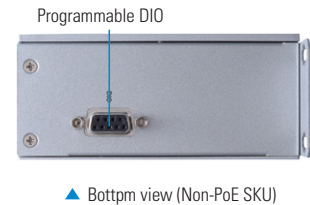
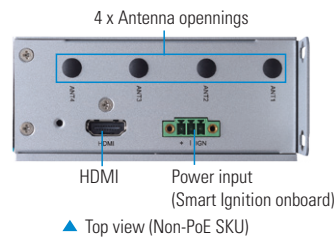
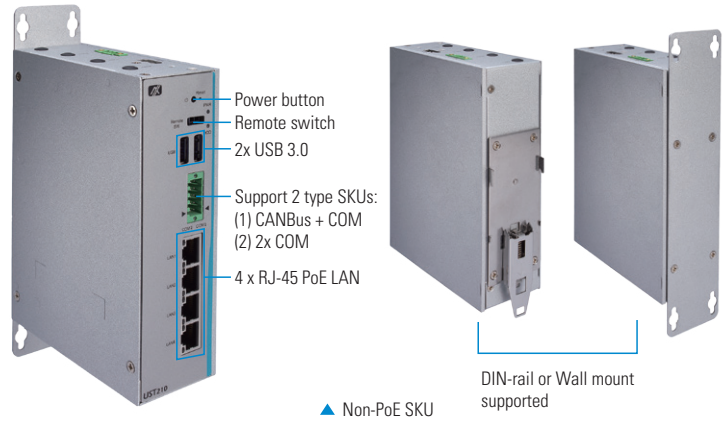

Specifications

Standard Color	Sliver	
Construction	Extruded aluminum and heavy-duty steel, IP20	
CPU	Intel® Atom® x5-E3940 2C @1.6 GHz, TDP: 9.5W	
Chipset	SoC integrated	
System Memory	1 x DDR3L-1866 SO-DIMM, up to 8GB	
BIOS	AMI	
TPM	TPM 2.0	
System I/O Outlet	Serial	Up to 2 x Terminal block Serial console or RS-232/422/485**
	CANBus	1 x Terminal block CANBus 2.0 A/B**, supports SocketCAN*
	Display	1 x HDMI (up to 1920x1080@60Hz)
	Ethernet	4 x RJ-45 isolated* 10/100/1000 Mbps Ethernet (Intel® i211-AT) *Isolation voltage: 1.5 kV
	USB	2 x USB 3.0
	DIO	1 x DB9 8-bit programmable DIO
	Others	4 x Antenna opening 1 x Power button 1 x Reset button 1 x Remote switch
Extension Interface	1 x Full-size Rev. 1.2 PCI Express Mini Card slot: • USB with SIM slot	
	1 x Half-size Rev. 1.2 PCI Express Mini Card slot: • mSATA/USB	
Storage	mSATA	1 x Half-sized mSATA (occupied 1 x PCI Express Mini Card slot)
	SATA Drive	1 x Internal 2.5" SATA drive (9.5 mm height)
Watchdog Timer	255 levels, 1 to 255 sec.	





Power	Power Supply	1 x Terminal block, 9 to 36 VDC (Typical 12/24 VDC) with smart ignition
	Power Consumption	Non-PoE SKU: 9 VDC, 3.878A; 36VDC, 0.85A PoE SKU: 9VDC 6.298A, 36VDC 1.617A
PoE (PSE, Power Sourcing Equipment)**	Up to 4 x configurable RJ-45 PoE output max. 30W supports PoE & PoE+ • PoE (802.3af 15.4W/port) • PoE+ (802.3at 30W/port)	
System Indicator	1 x LED indicator for SATA drive activity 1 x LED indicator for power	
Operating Temperature	-40°C to +70°C (-40°F to +158°F) with W.T. peripheral***	
Humidity	0% to 95%, non-condensing	
Dimensions	Non-PoE SKU: 48 mm (1.89") (W) x 110 mm (4.33") (D) x 155 mm (6.1") (H) PoE SKU: 66.7 mm (2.63") (W) x 110 mm (4.33") (D) x 155 mm (6.1") (H)	
Mounting	Wall mount, DIN-rail	
Weight (net/gross)	Non-PoE SKU: 0.51 kg (1.12 lb)/0.79 kg (1.74 lb) PoE SKU: TBA	
Certifications	CE (Class A), FCC (Class A) certified; ISO 7637-2 compliant	
EMC	CE/FCC	EN 55032 (Class A), EN 55024, FCC part 15 B (Class A)
Vibration Endurance	3 Gms with mSATA and SSD (5 to 500Hz, X/Y/Z direction; random, operating) MIL-STD-810G, Method 514.6C-VI Category 4 compliant	
EOS Support	Windows® 10 64-bit, Ubuntu 18.04	
Software Support	AMS.AXView	

* Please refer the detail in SocketCAN manual.

** See Ordering information.

*** Wide Temperature. All W.T. supported products have to be sorted by Axiomtek.

Ordering Information

Standard	
UST210-83K-FL-E3940-CANCOM-TVDC (P/N: E274210100)	Fanless embedded system with Intel® Atom® x5-E3940 processor, 1 CAN, 1COM, 4 LAN, 2 USB, 1 DIO and 1 HDMI, operating temperature from -40 to 70°C, TPM 2.0 supported, with Smart Ignition  <i>Non-PoE SKU</i>
UST210-83K-FL-E3940-2COM-TVDC	Fanless embedded system with Intel® Atom® x5-E3940 processor, 2COM, 4 LAN, 2 USB, 1 DIO and 1 HDMI, operating temperature from -40 to 70°C, TPM 2.0 supported, with Smart Ignition  <i>Non-PoE SKU</i>
UST210-83K-FL-E3940-CANCOM-POE-TVDC	Fanless embedded system with Intel® Atom® x5-E3940 processor, 1 CAN, 1COM, 4 PoE LAN, 2 USB, 1 DIO and 1 HDMI, operating temperature from -40 to 70°C, TPM 2.0 supported, with Smart Ignition  <i>PoE SKU</i>
UST210-83K-FL-E3940-2COM-POE-TVDC	Fanless embedded system with Intel® Atom® x5-E3940 processor, 2COM, 4 LAN, 2 USB, 1 DIO and 1 HDMI, operating temperature from -40 to 70°C, TPM 2.0 supported, with Smart Ignition  <i>PoE SKU</i>

Optional	
Communication Modules	8812C300GA0E 3G UC20GKit tBOX/ICO(20) (E) 8812C300HA0E 3G/GPS UC20GKit tBOX/ICO(20) (E) 8812C300IA0E LTE SIM7100JC Kit for ICO(20) JPN SFP(E) 8812C300EA0E LTE SIMCOM SIM7100C(TW) for ICO300 SFP(E) 8812C300DA0E LTE SIMCOM SIM7100E(EU) for ICO300 SFP(E)
AC to DC Adapter	50906D24000E Adaptor 24V/120W, wire only, FSP120-AAAN3

* Specifications and certifications may vary based on different requirements.

Dimensions

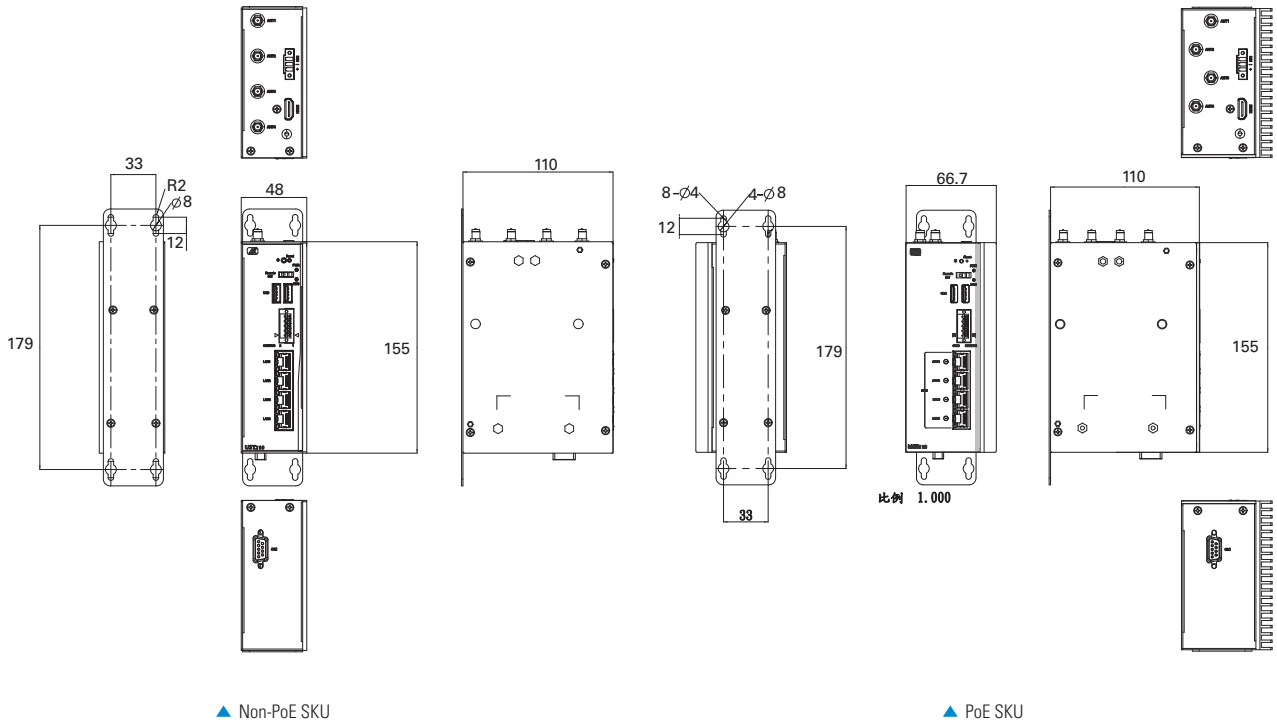

Power Protection

OCP (over current protection)
OVP (over voltage protection)
UVP (under voltage protection)
RPP (reverse polarity protection)
ISO 7637-2 pulse 1, 2a, 2b, 3a, 3b, 4(vehicle version)
Setting for in-vehicle battery protection: system will be automatically turned down at low voltage level
Setting for ignition control: system will activate a counter while in-vehicle battery at low voltage, ACC-on delay and shut down delay