

User Manual

BPC-3040

Fanless Compact Embedded Box PC
with Intel® Apollo Lake Pentium® N4200 Processor

Record of Revisions

Version	Issue Date	Descriptions	Made By
1.0	2021/07/30	First Release	Derek

Copyright

The documentation and the software included with this product are copyrighted by Arestech Cooperation Co., Ltd. All rights are reserved. No part of this manual may be reproduced, copied, translated, or transmitted in any form or by any means without the prior written permission of Arestech Cooperation Co., Ltd. Information provided in this manual is intended to be accurate and reliable.

Trademark Acknowledgement

Brand and product names are registered trademarks of their respective owners.

Disclaimer

Arestech reserves the right to make changes, without notice, to any product described or contained in this manual to improve design and/or performance. Applications that are described in this manual are for illustration purposes only. Arestech makes no representation or guarantee that such application will be suitable for the specified use without further testing or modification. This manual might include unintentional typographical or technical errors. Arestech will periodically correct such erroneous files and incorporate these corrections into the new version of the manual.

Technical Support and Assistance

If there is a problem with your product and you are unable to get a solution from the user's manual, please contact the local distributor.

Product Warranty (2 Years)

Arestech warrants to you, the original purchaser, that each of its products will be free from defects in materials and workmanship for two years from the invoice date. This warranty does not apply to any products which have been repaired or altered by persons other than repair personnel authorized by Arestech, or which have been subject to misuse, abuse, accident, or improper installation. Arestech assumes no liability under the terms of this warranty as a consequence of such events. When a defect is discovered, please obtain an RMA (return merchandise authorization) from our website, which allows us to process your return more quickly. The returned product must be properly packaged in its original packaging to obtain warranty service.

Safety Instructions

1. Read these safety instructions carefully.
2. Keep this User Manual for later reference.
3. Disconnect this equipment from any AC outlet before cleaning. Use a damp cloth. Do not use liquid or spray detergents for cleaning.
4. For plug-in equipment, the power outlet socket must be located near the equipment and must be easily accessible.
5. Keep this equipment away from humidity.

6. Put this equipment on a reliable surface during installation. Dropping it or letting it fall may cause damage.
7. The openings on the enclosure are for air convection. Protect the equipment from overheating. **DO NOT COVER THE OPENINGS.**
8. Make sure the voltage of the power source is correct before connecting the equipment to the power outlet.
9. Position the power cord so that people cannot step on it. Do not place anything over the power cord.
10. All cautions and warnings on the equipment should be noted.
11. If the equipment is not used for a long time, disconnect it from the power source to avoid damage by transient overvoltage.
12. Never pour any liquid into an opening. This may cause fire or electrical shock.
13. For safety reasons, the equipment should be opened only by qualified service personnel. If one of the following situations arises, get the equipment checked by service personnel:
 - The power cord or plug is damaged.
 - Liquid has penetrated into the equipment.
 - The equipment has been exposed to moisture.
 - The equipment does not work well, or you cannot get it to work according to the user manual.
 - The equipment has been dropped and damaged.
 - The equipment has obvious signs of breakage.
14. **DO NOT LEAVE THIS EQUIPMENT IN AN ENVIRONMENT WHERE THE STORAGE TEMPERATURE MAY GO BELOW -20° C (-4° F) OR ABOVE 55° C (131° F). THIS COULD DAMAGE THE EQUIPMENT. THE EQUIPMENT SHOULD BE IN A CONTROLLED ENVIRONMENT.**
15. **CAUTION: DANGER OF EXPLOSION IF BATTERY IS INCORRECTLY REPLACED. REPLACE ONLY WITH THE SAME OR EQUIVALENT TYPE RECOMMENDED BY THE MANUFACTURER, DISCARD USED BATTERIES ACCORDING TO THE MANUFACTURER'S INSTRUCTIONS.**

Safety Precaution - Static Electricity

Follow these simple precautions to protect yourself from harm and the products from damage:

1. To avoid electrical shock, always disconnect the power from your PC chassis before you work on it. Don't touch any components on the CPU card or other cards while the PC is on.
2. Disconnect power before making any configuration changes. The sudden rush of power as you connect a jumper or install a card may damage sensitive electronic components.

Contents

Chapter 1. General Introduction.....	7
1.1 I/O Arrangement	7
1.2 Internal Interfaces	12
1.3 Mechanical Dimensions.....	14
Chapter 2. System Setup	15
2.1 Power Installation Procedure	15
2.2 Installing 2.5" HDD and Swappable HDD Bracket	17
2.3 Installing Memory and Internal Expansion Device	18
2.4 Installing mini-PCIe Card.....	19
Chapter 3. BIOS Setting	21
3.1 Main.....	22
3.2 Advanced	23
3.2.1 TPM Configuration.....	24
3.2.2 Super IO Configuration	25
3.2.3 Hardware Monitor	26
3.2.4 S5 RTC Wake Configuration.....	27
3.2.5 CPU Configuration	28
3.2.6 SATA Configuration.....	29
3.2.7 OS Selection	30
3.3 Chipset	31
3.4 Security	33
3.5 Boot	34
3.6 Exit	35

Chapter 1. General Introduction

1.1 I/O Arrangement

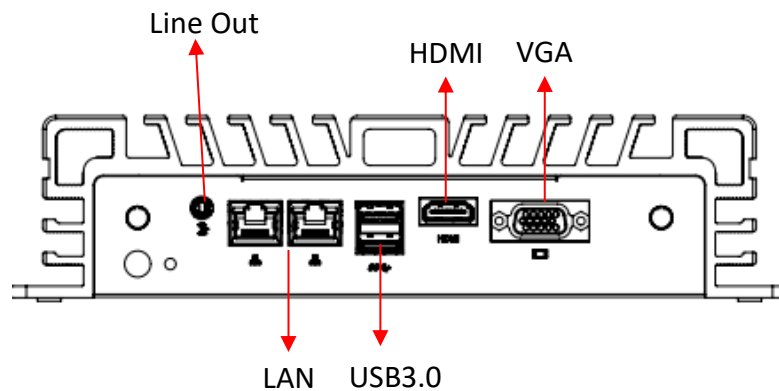
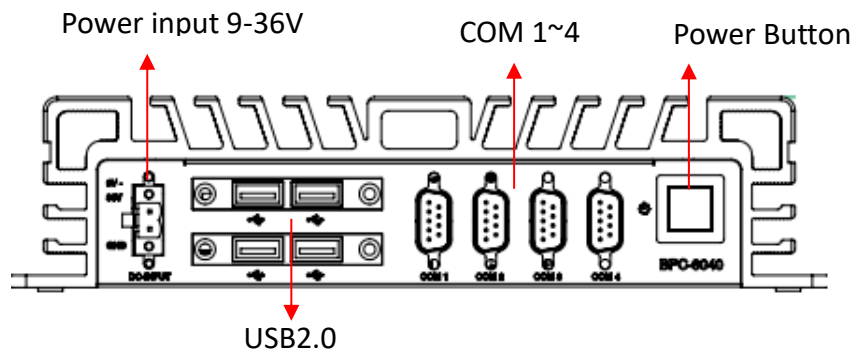

■ Power Button

Press this button to turn on the system.

The LED is on when the system is operating.

The LED keeps blinking when the system is in S1 sleep state.

The LED is off when the system is in S3/S4 sleep state or powered off (S5).

■ DC 9~36V Power Input Connector

This system supports DC 9-36V power input. The connector must be connected to DC 9-36V power adaptor. After plugging in the phoenix connector, be sure to fasten the two screws to lock the connector.

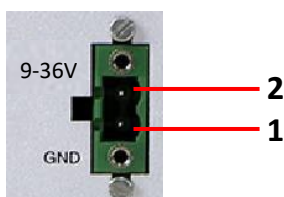

Pin	Definition
1	GND
2	Vin+ (9-36V DC)

■ **VGA Port**

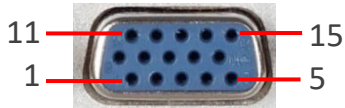

Pin	Definition	Pin	Definition
1	RED	9	VCC
2	GREEN	10	GND
3	BLUE	11	NC
4	NC	12	DAT
5	GND	13	HSYNC
6	GND	14	VSYNC
7	GND	15	CLK
8	GND		

■ **Audio Port**

Green connector means **LINE OUT**.

■ **HDMI Port**

This port can be connected to an HDMI monitor.

1 x HDMI 1.4 port supports a maximum resolution of 3840 x 2160 @ 30 Hz.

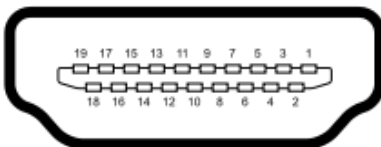

Pin	Definition	Pin	Definition
1	TMDS Data2+	2	TMDS Data2 Shield
3	TMDS Data2 -	4	TMDS Data1+
5	TMDS Data1 Shield	6	TMDS Data1-
7	TMDS Data0+	8	TMDS Data0 Shield
9	TMDS Data0-	10	TMDS Clock+
11	TMDS Clock Shield	12	TMDS Clock-
13	Reserved	14	Reserved

15	SCL	16	SDA
17	DDCGround	18	+5 V Power
19	Hot Plug Detect		
10	ML_Lane3[p]	20	DP_PWR

■ **LAN Port**

This port can be connected to Ethernet via RJ-45 connector.

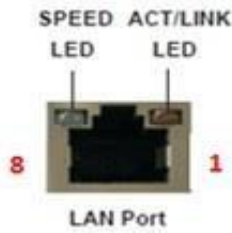

10/100BASE-T:

Pin	Definition	Pin	Definition
1	TX_D0+	5	NC
2	TX_D0-	6	RX_D1-
3	RX_D1+	7	NC
4	NC	8	NC

1000BASE-T:

Pin	Definition	Pin	Definition
1	TX_D0+	5	BI_D2-
2	TX_D0-	6	RX_D1-
3	RX_D1+	7	BI_D3+
4	BI_D2+	8	BI_D3-

Activity/Link LED	
Status	Description
Off	No Link
Blinking	Data Activity
On	Link

SPEED LED	
Status	Description
Off	10Mbps connection
Green	100Mbps connection
Orange	1Gbps connection

■ USB 3.0 Port

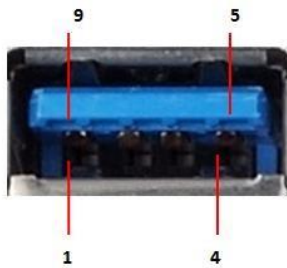

Pin	Definition
1	+5
2	USB-
3	USB+
4	GND
5	StdA_SSRX-
6	StdA_SSRX+
7	GND_DRAIN
8	StdA_SSTX-
9	StdA_SSTX+

Basically, USB3.0 supports 900mA @ 5 V.

■ ANT

These are reserved holes for SMA connectors of antennas. When a customer selects a 4G or a Wi-Fi module, they will need the ANT hole for plugging in a SMA connector.

■ COM1 (RS-232/422/485), COM 2/3/4(RS-232)

(RS-232)

Pin	Definition	Pin	Definition
1	DCD	6	DSR
2	RXD	7	RTS
3	TXD	8	CTS
4	DTR	9	RI/5V/12V
5	GND		

(RS-422)

Pin	Definition	Pin	Definition
1	TX-	6	N/A
2	TX+	7	N/A
3	RX+	8	N/A
4	RX-	9	RI/5V/12V
5	GND		

(RS-485)

Pin	Definition	Pin	Definition
1	RTX-	6	N/A
2	RTX+	7	N/A
3	N/A	8	N/A
4	N/A	9	RI/5V/12V
5	GND		

© NOTE: THE PARAMETERS OF COM1 CAN BE SET BY JUMPER SETTING.

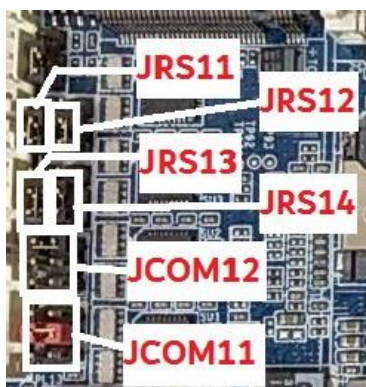

Description

5V/12V/RI signal select jumper for Serial port header#1 (JCOM11)

1-2 Close: 5V (Power COM)

3-4 Close: RI (Stand COM)

5-6 Close: 12V (power COM)

Pin No.	Definition
1	VCC
2	RI1-/5V/12V
3	NRI1-
4	RI1-/5V/12V
5	+12V
6	RI1-/5V/12V

RS232/RS422/RS485 select jumper for Serial port header#1 (JCOM12/JRS13/JRS14/JRS11/JRS12)

1-2 Close: RS232

3-4 Close: RS422

5-6 Close: RS485

1-2 Close: RS422/RS485

2-3 Close: RS232 (Default setting)

Pin No.	Definition
1	RXD232
2	RXD1
3	RXD422
4	RXD1
5	RXD485
6	RXD1

1.2 Internal Interfaces

■ SATA Connector



Pin	Definition
1	GND
2	TX+
3	TX-
4	GND
5	RX-
6	RX+
7	GND

■ SATA Power Connector

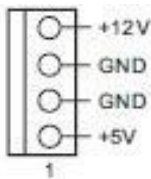

Pin	Definition
1	+5V
2	GND
3	GND
4	+12V

■ mini-PCle Slot

1 x full-size mini-PCle (PCIe x1 + USB2.0) slot with SIM holder.

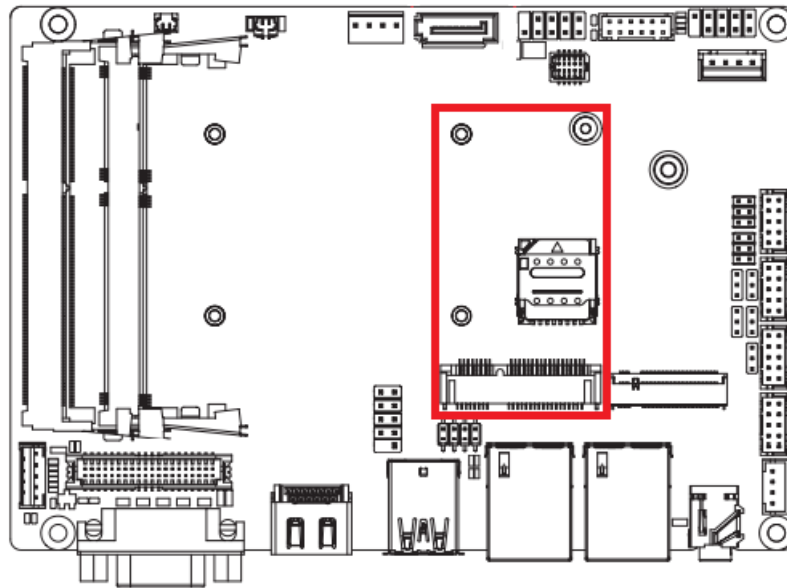

- **M.2 Slot**
1 x 2242 M key SATA III.

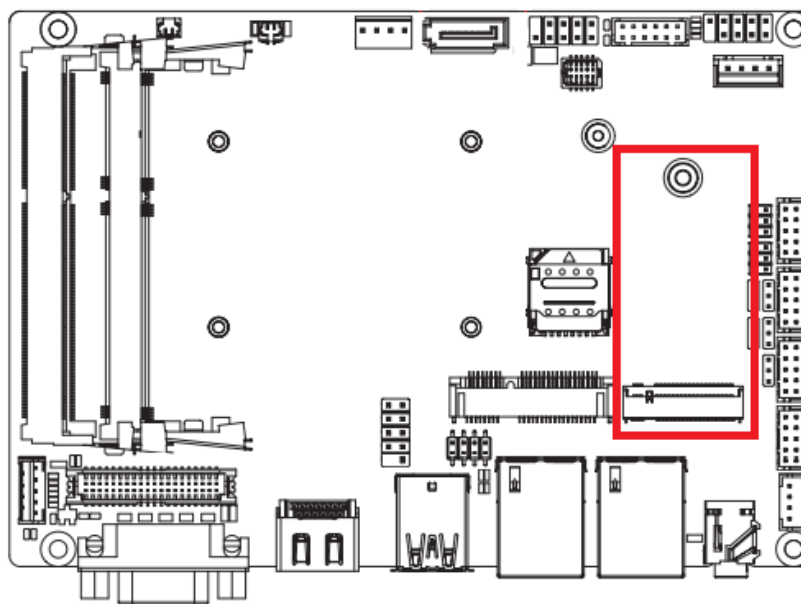

1.3 Mechanical Dimensions

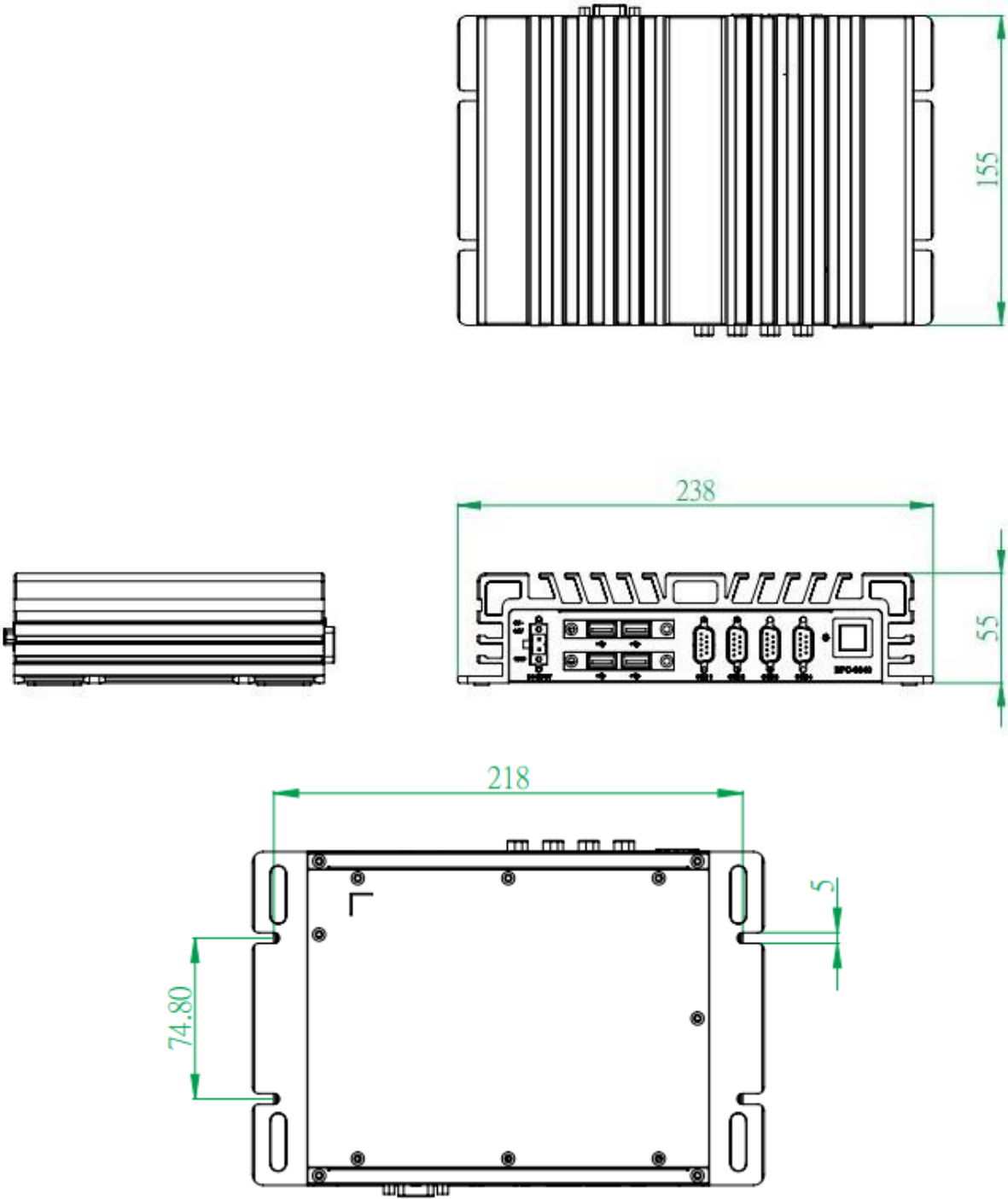

Chapter 2. System Setup

2.1 Power Installation Procedure

■ Connect Power Cord

This box pc can support wide-range DC input (9-36V). Be sure to hold the power cord by the plug end only. Please follow the steps below to connect the power cord:

1. Connect the male end (Phoenix connector) of the power cord to the DC input connector of BPC-3040 and lock it up.



2. Connect the 3-pin male plug of the power cord to an electrical outlet.
3. Connect the Phoenix connector terminal to the system's power input connector.

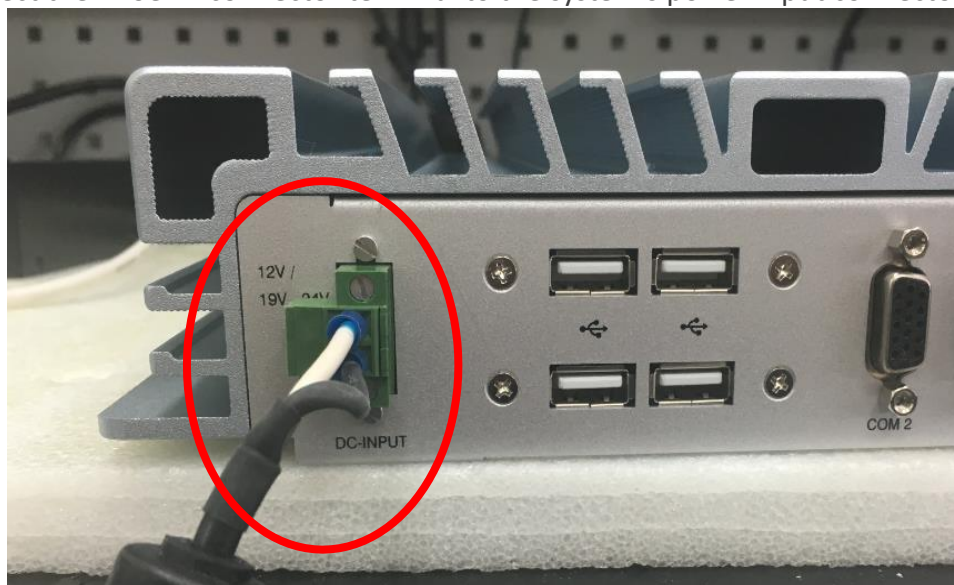

**WARNING:**

1. AFTER PLUGGING IN THE PHOENIX CONNECTOR, BE SURE TO FASTEN THE TWO SCREWS TO LOCK THE CONNECTOR.
2. WHITE CABLE STANDS FOR 12V, BLACK CABLE STANDS FOR GND. MAKE SURE THE CONNECTOR IS PLUGGED IN WITH CORRECT DIRECTION.

■ Connect Keyboard and Mouse

Connect the mouse and keyboard to the USB connectors of BPC-3040.

■ Turn on Power

The power button is located at the right side of the front cover of the box pc.

2.2 Installing 2.5" HDD and Swappable HDD Bracket

- Step 1: Unfasten the 8 screws on the chassis and open the bottom cover.



- Step 2: Unfasten the SATA cable and SATA power cable on the HDD/SSD.



- Step 3: Unfasten the 4 screws on the HDD/SSD bracket.



- Step 4: Install another HDD/SSD and fasten all screws.

© **NOTE: THE BRACKET ONLY SUPPORTS 7MM HDD/SSD.**

2.3 Installing Memory and Internal Expansion Device

This box pc provides one 204-pin DDR3L SO-DIMM slot, supporting single channel DDR3L SDRAM only.

- **Step 1:** The notch on the SO-DIMM should be lined up with the slot key.

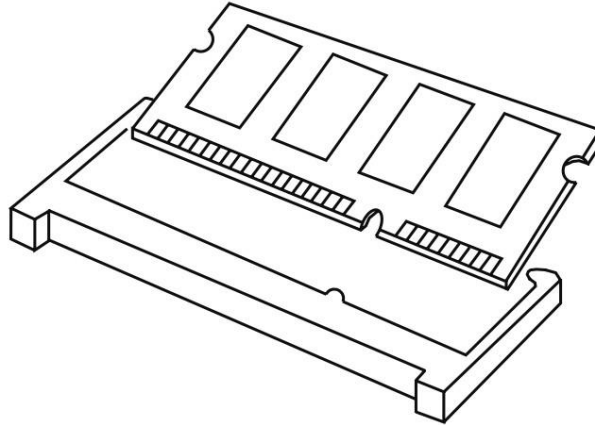

- **Step 2:** Firmly insert the SO-DIMM into the slot until the retaining clips at both ends fully snap back, and the SO-DIMM is properly hold in place.

2.4 Installing mini-PCIe Card

Expansion Slots mini-PCIe

There is 1x full mini-PCIe slot and 1x M.2 2242 M key slot.

■ mPCIe /m-SATA Placement

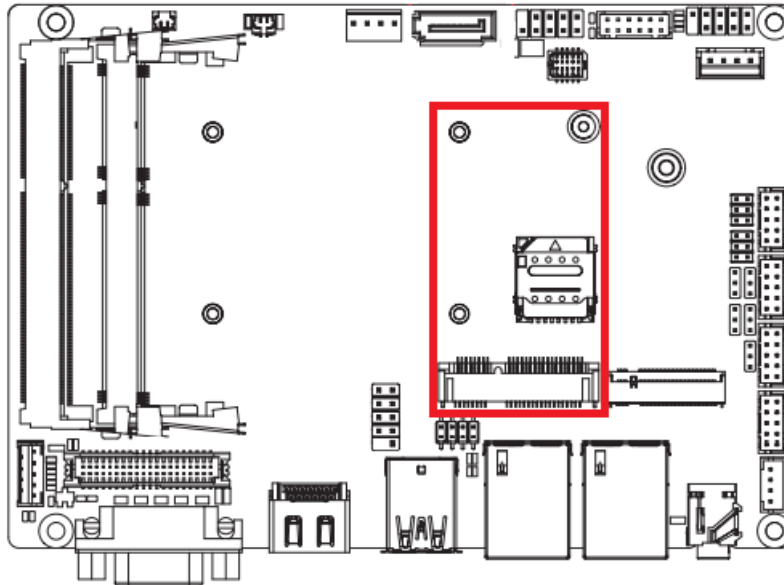

■ M.2 Placement

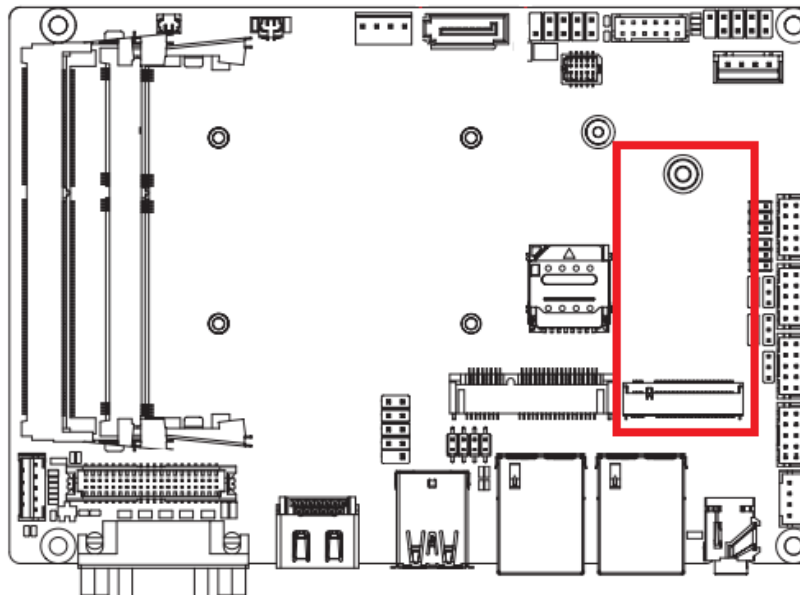

■ Installing An Expansion Card

1. Before installing the expansion card, please make sure that the power supply is switched off or the power cord is unplugged. Please read the documentation of the expansion card and make necessary hardware settings for the card before you start the installation.
2. Remove the system unit cover.
3. Align the card connector with the slot and press firmly until the card is completely hold in place.
4. Fasten the card to the chassis with screws.
5. Put the system cover back on.

Chapter 3. BIOS Setting

The BIOS (Basic Input/Output System) installed in your computer system's ROM supports Intel® processors. The BIOS provides critical low-level support for a standard device such as disk drives, serial ports, and parallel ports. It also adds virus and password protection as well as special support for detailed fine-tuning of the chipset controlling the entire system. The BIOS provides a setup utility program for specifying the system configurations and settings. The BIOS ROM of the system stores the setup utility.

When you turn on the computer, the BIOS is immediately activated. Pressing the key immediately allows you to enter the setup utility. When you enter the BIOS setup utility, the top of the screen has a menu bar with the following selections:

- **Main:** To set up the system time/date information
- **Advanced:** To set up the advanced UEFI features
- **H/W Monitor:** To display current hardware status
- **Security:** To set up the security features
- **Boot:** To set up the default system device to locate and load the operating system
- **Exit:** To exit the current screen or the UEFI setup utility

Use ← key or → key to choose the selections on the menu bar.

Use <Enter> key to get into the sub screen or an item.

Use ↓ key or ↑ key to move the cursor down or up to select items.

Use <Exit> key to exit the current screen.

3.1 Main

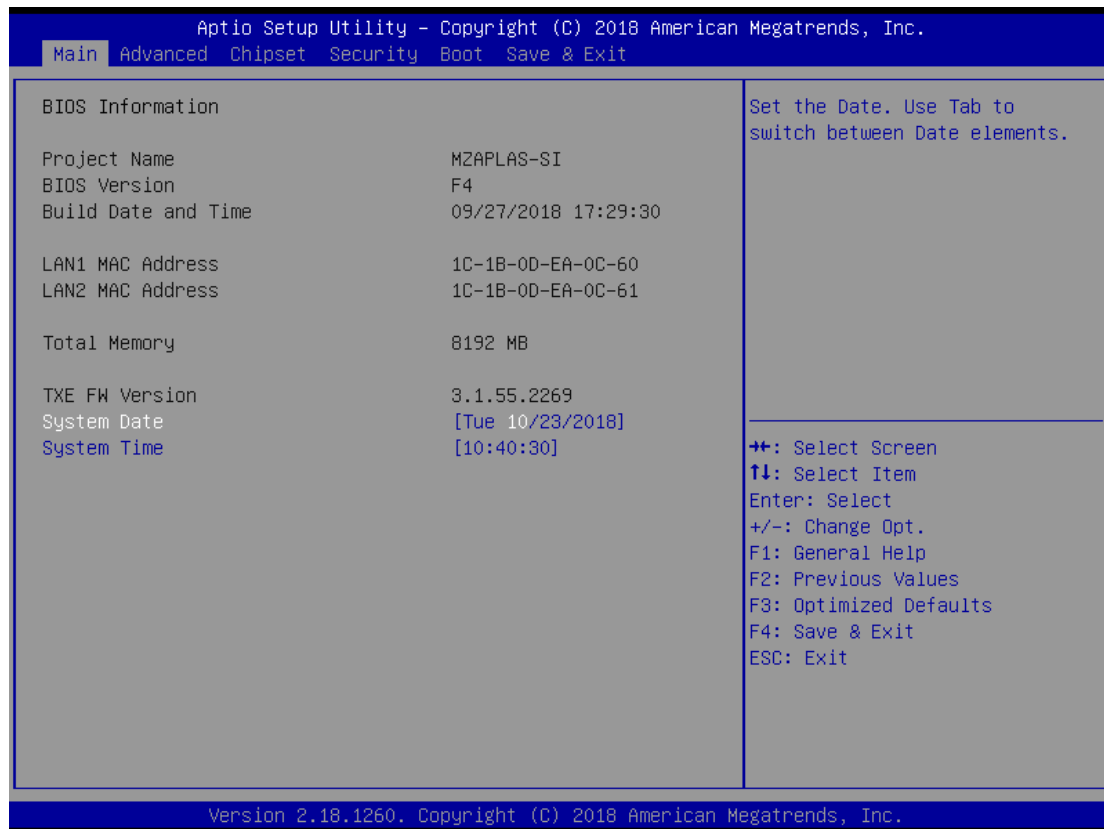

© NOTE: TO CLEAR CMOS, PLEASE SHORT THE TWO PINS INDICATED BELOW.

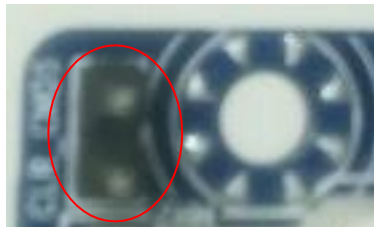

3.2 Advanced



3.2.1 TPM Configuration



- **fTPM**
This item allows users to enable or disable the fTPM.
- **Trusted Computing**
This item allows users to enable or disable the Security Device Support.

3.2.2 Super IO Configuration

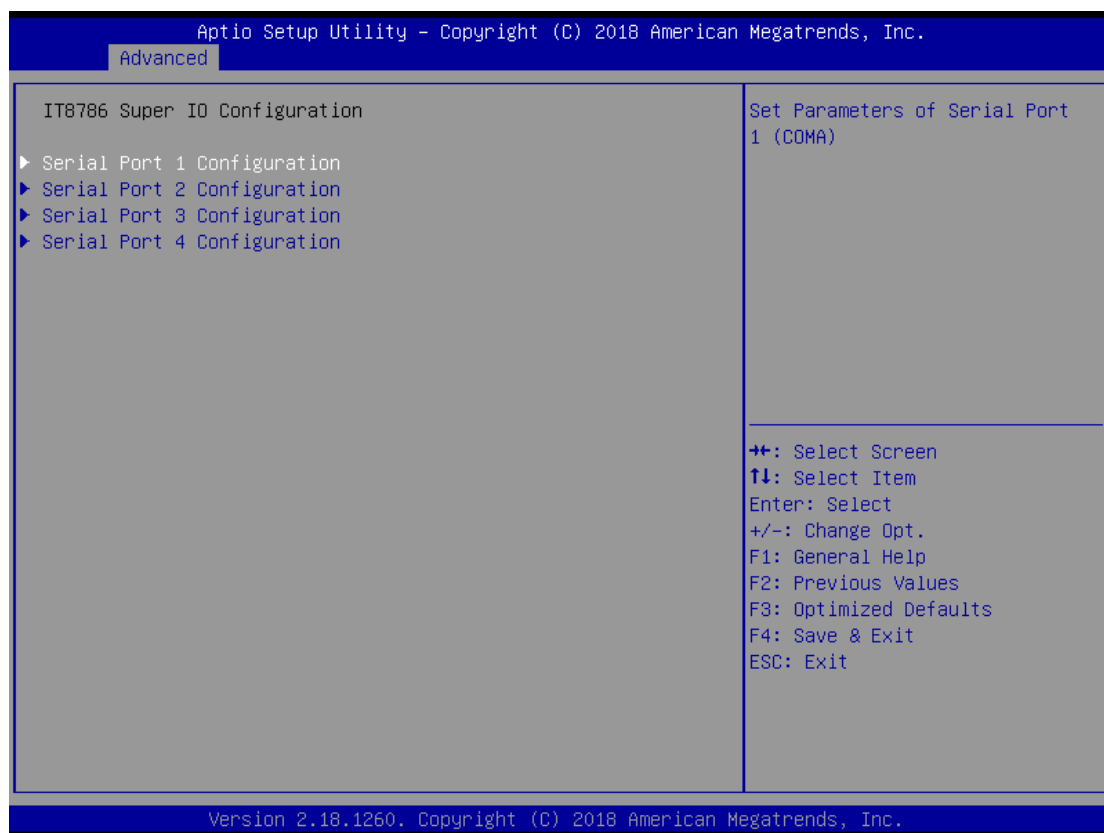

- **COM1 Configuration**
This item allows users to enable or disable COM1.
- **COM2 Configuration**
This item allows users to enable or disable COM2.
- **COM3 Configuration**
This item allows users to enable or disable COM3.
- **COM4 Configuration**
This item allows users to enable or disable COM4.

3.2.3 Hardware Monitor

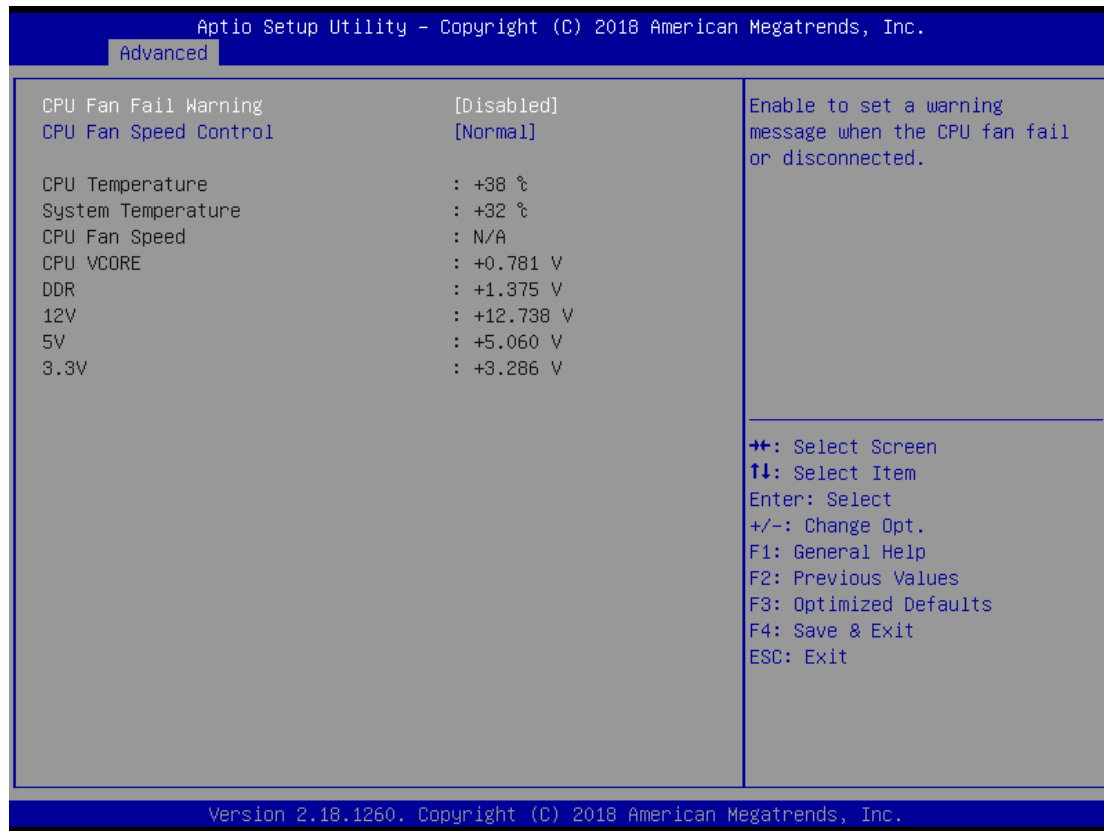

- **CPU Fan Fail Warning**
This item allows users to enable or disable the CPU Fan Fail Warning.
- **CPU Fan Speed Control**
This item allows users to select CPU Fan Speed as [Normal] or [Full Speed].

3.2.4 S5 RTC Wake Configuration

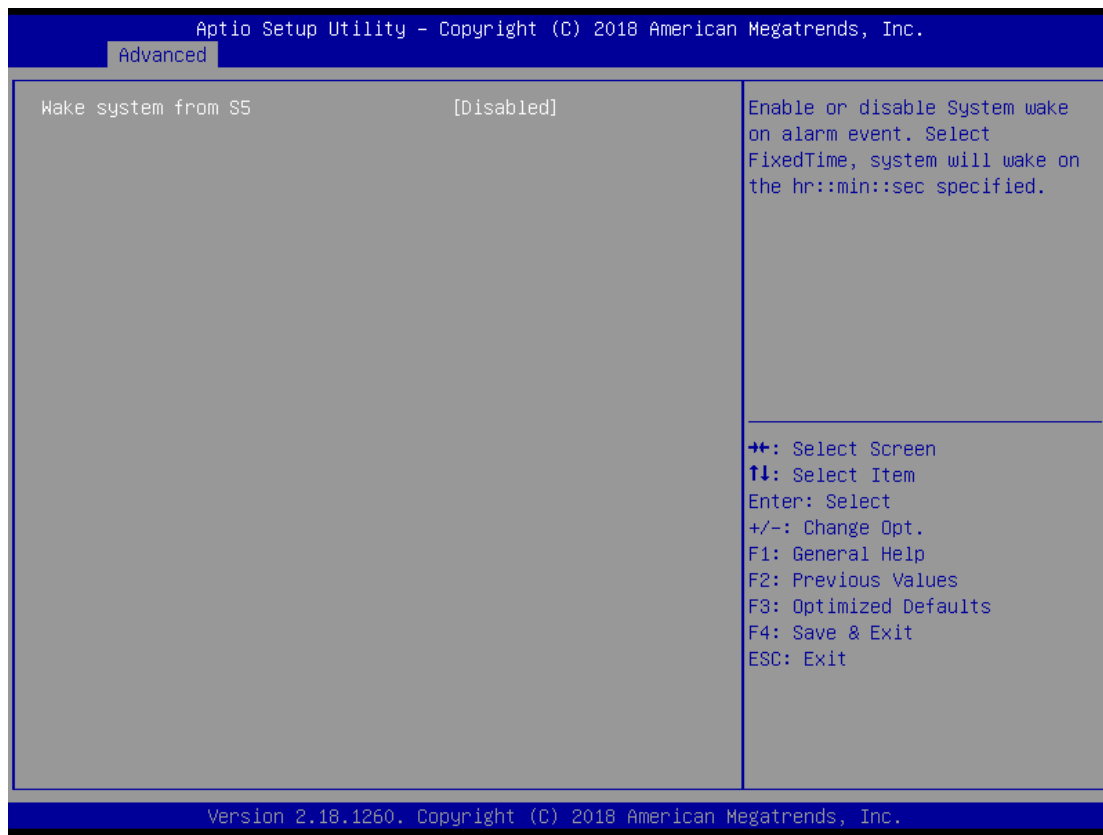

- **Wake system from S5**

This item allows users to set Fixed Time or disable System wake on alarm event. Select Time System will wake on the hr:: min::sec:: specified.

3.2.5 CPU Configuration

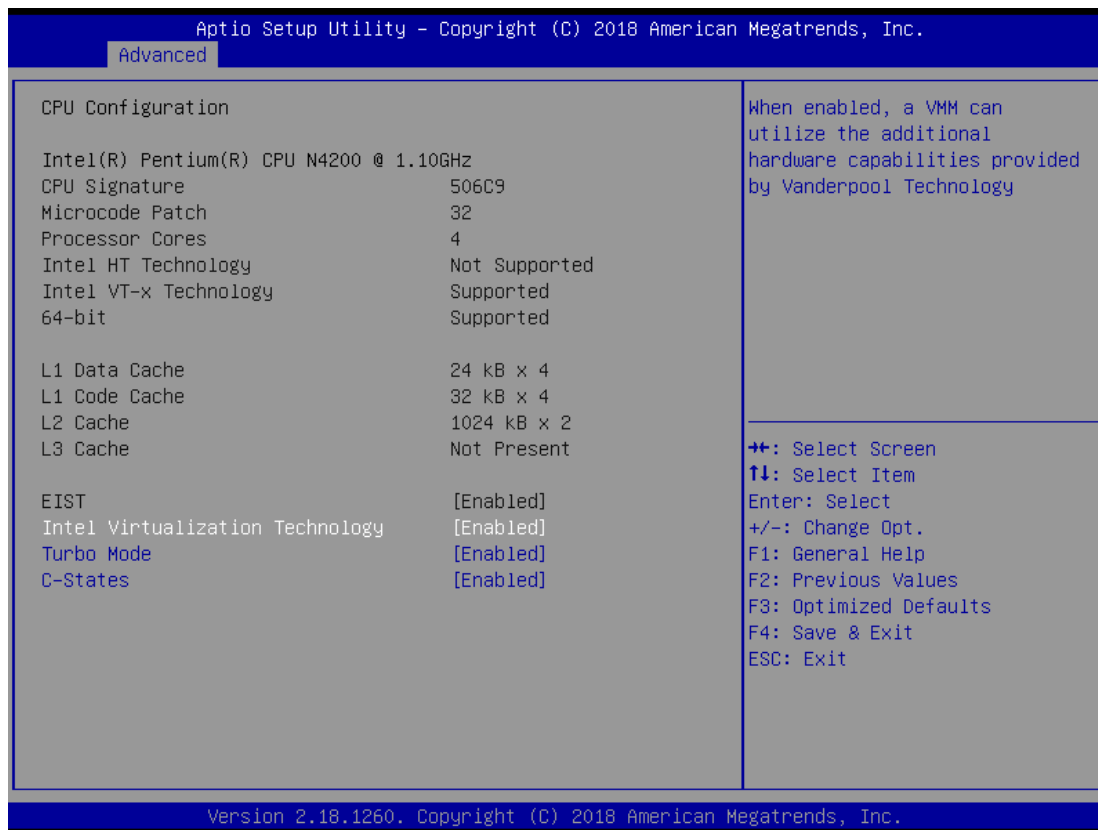

- **Intel Virtualization Technology**

This item allows users to enable or disable Intel Virtualization Technology.

Select [Enabled] can utilize the additional hardware capabilities provided by Vanderpool Technology.

- **Turbo Mode**

This item allows users to enable or disable Turbo mode.

- **C-States**

This item allows users to enable or disable C-States.

3.2.6 SATA Configuration



- **SATA Mode Selection**
The M/B only supports AHCI mode.
- **SATA**
This item is used to check the hard disk model and capacity.
- **M.2**
This item is used to check the M.2 SSD model and capacity.

3.2.7 OS Selection



- **CSM Support**
Never support CSM.
- **LAN EFI Driver**
This item allows users to enable or disable the LAN EFI Driver.

3.3 Chipset

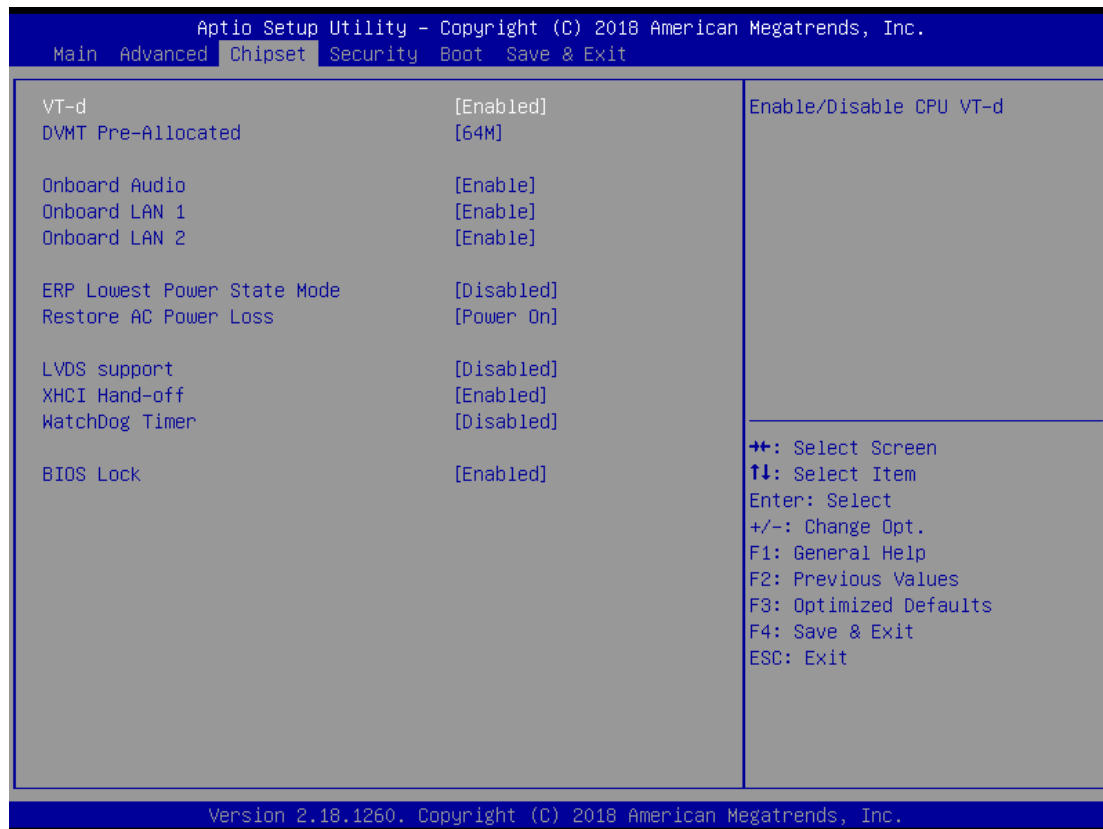

- **VT-d**

This item allows users to enable or disable the VT-d. The default value is [Enabled].
- **DVMT Pre-Allocated**

This item allows users to set DVMT as [64M], [128M], [256M], or [512M]. The default value is [64M].
- **Onboard Audio**

This item allows users to enable or disable the Onboard Audio. The default value is [Enabled].
- **Onboard LAN 1**

This item allows users to enable or disable the Onboard LAN 1. The default value is [Enabled].
- **Onboard LAN 2**

This item allows users to enable or disable the Onboard LAN 2. The default value is [Enabled].
- **ERP Lowest Power State Mode**

This item allows users to enable or disable the ERP Lowest Power StateMode. The default value is [Disabled].

- **Restore AC Power Loss (AT/ATX Power Setting)**
This item allows users to set Restore AC Power Loss as [Power On], [PowerOff], or [Last State]. The default value is [Power On].
- **LVDS Support**
This item allows users to enable or disable the LVDS support. The default value is [Disabled].
- **XHCI Hand-off**
This item allows users to enable or disable the XHCI Hand-off. The default value is [Enabled].
- **WatchDog Timer**
This item allows users to set WatchDog Timer as [15S], [30S], [45S], [60S], or [Disabled]. The default value is [Disabled].
- **BIOS Lock**
This item allows users to enable or disable the BIOS Lock. The default value is [Enabled].

3.4 Security



■ Administrator Password

This is used to set or change the password for the administrator account. Only the administrator has the authority to change the settings in the UEFI Setup Utility. Leave it blank and press enter to remove the password.

■ User Password

This is used to set or change the password for the user account. Users are unable to change the settings in the UEFI Setup Utility. Leave it blank and press enter to remove the password.

■ Secure Boot

1. Secure Boot Control

This item allows users to enable or disable the Secure Boot Control. The default value is [Enabled].

2. Secure Boot Mode

This item allows users to choose [Standard] or [Custom] as the Secure Boot Mode. The default value is [Standard].

3.5 Boot



- **Full Screen LOGO Show**

This item allows users to enable or disable the Full Screen LOGO Show. The default value is [Disabled].

- **Boot Option #1**

This item allows users to set the system boot order.

3.6 Exit

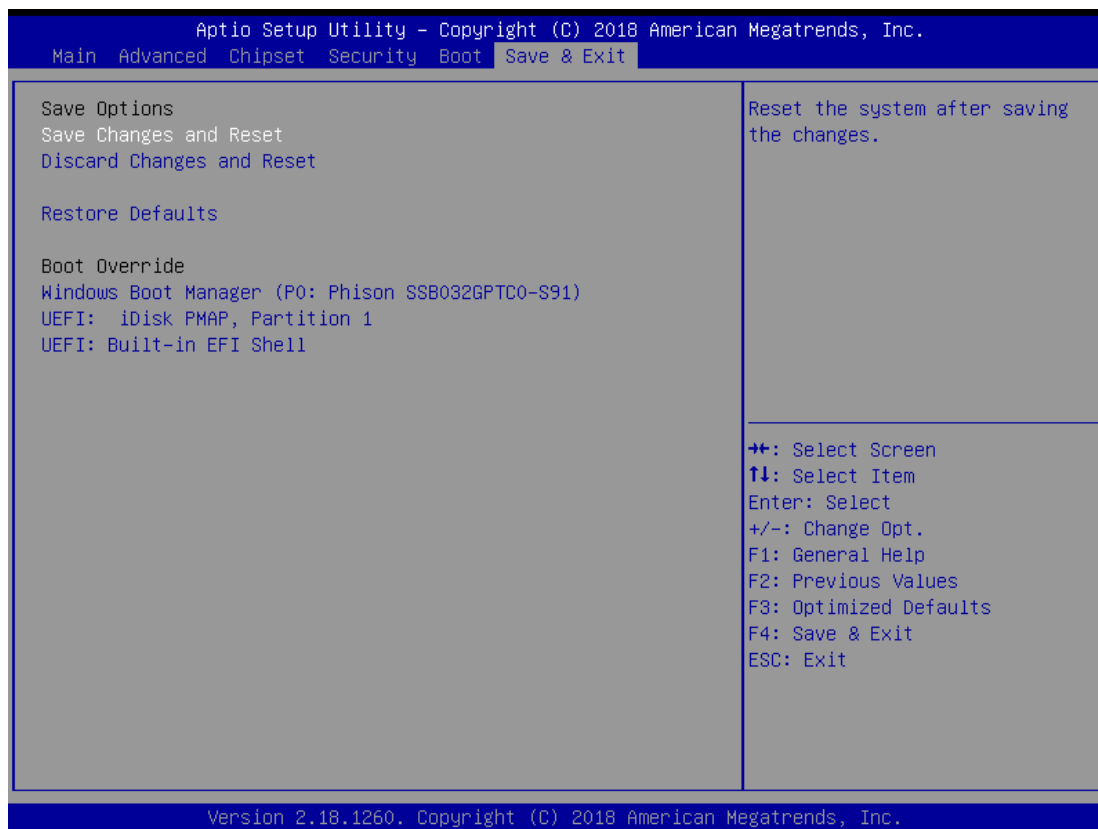

- **Save Changes and Reset**

When this option is selected, the following message will pop up: “Save configuration changes and reset?”. Select [OK] to save the changes and exit the UEFI SETUP UTILITY.

- **Discard Changes and Reset**

When this option is selected, the following message will pop up: “Reset without saving?”. Select [OK] to exit the UEFI SETUP UTILITY without saving any changes.

- **Restore Defaults**

Restore/Load default values for all setup options.

- **Boot Override**

Let the user select the boot device.