

UNO-1372G

Intel® Atom™ Quad-Core Small- Size Control DIN-Rail PC w/ 3 x GbE, on-board 4GB DDR3L SDRAM, 2 x mPCIe, 1 mSATA, 2 x COM, 8 x DI/O, 3 x USB, HDMI/VGA

NEW



Features

- Intel® Atom E3845 1.91GHz processor with 4GB DDR3L Memory
- 3 x GbE, 3 x USB, 2 x COM, 1 x VGA, 1 x HDMI, Audio, iDoor, mSATA, 2mPCIe, 1 x SATA, 8 x DIO, 1 x Power Terminal
- Compact with Fanless Design
- Dual Power Input for Reducing Power Down Time
- Exchangeable RTC Battery with easy Access on the Top
- Digital I/O with Isolation Protection for Sensing and controlling
- Diverse system IO and Supports Fieldbus Protocol by iDoor Technology as a Protocol Gateway
- 3G/GPRS/Wi-Fi Communication by iDoor Technology as a Communication Gateway
- Supports MRAM by iDoor Technology
- Chassis Grounding Protection
- LAN Redundancy (Teaming)

Introduction

The UNO-1372G is an Intel Atom Quad-Core DIN-Rail controller. This controller featured with dual power input that shorten the down time to enhance operation excellence. The general purpose input/output ports also help machine builders integrate direct control of start/stop inspection and indicate inspection results. The UNO-1372G is also equipped with Advantech iDoor technology that uses iDoor modules to extend this product to become a gateway controller, such as a PoE card, or isolation serial port card. The UNO-1372G also features 3 gigabyte LAN ports, 1 USB 3.0 port, 2 COM ports and HDMI& VGA display ports for essential upstream and downstream links, for example, PoE connected to IP camera from iDoor.

Specifications

General

- **Certification** CE, FCC, UL, CCC, BSMI
- **Dimensions (W x D x H)** 85 x 139 x 152 mm (3.3" x 5.5" x 6.0")
- **Form Factor** Small Size
- **Enclosure** Aluminum Housing
- **Mounting** DIN-rail, Wallmount
- **Weight (Net)** 1.6kg (3.5lbs)
- **Power Requirement** 9~36V_{dc}
- **Power Consumption** 24W (Typical)
- **OS Support** Microsoft® Windows 7/8, WES7/WES8, Linux

System Hardware

- **BIOS** AMI UEFI 128Mbit Flash BIOS
- **Watchdog Timer** Programmable 6 levels timer interval, from 15 to 255 sec
- **Processor** Intel Atom E3845 1.91GHz, 2MB L2 Cache
- **System Chip** Integrated Intel SoC Chipset
- **Memory** On-board 4GB DDR3L 1333 MHz
- **Graphics Engine** Intel® HD Graphics
- **Ethernet** Intel® 1210-IT GbE, 802.1Qav, 802.1AS, 802.3az Realtek RTL8111E GbE
- **LED Indicators** LEDs for Power, battery, LAN (Active, Status), Tx/Rx and HDD
- **Storage** One drive bay for SATA 2.5" HDD (Compatible with 9.5mm height HDD)
CFast drive by iDoor Technology (Optional)
- **Expansion** 2 x Full-size mPCIe slot, 1x mSATA (Full-size)

I/O Interfaces

- **Serial Ports** 1 x RS-232, DB9, 50~115.2kbps
1 x RS-422/485, DB9, auto flow control, 50~115.2kbps
- **LAN Ports** 3 x RJ45, 10/100/1000 Mbps IEEE 802.3u 1000Base-T Fast Ethernet, support Jumbo Frame
- **USB Ports** 3 x USB Ports (2 x USB2.0, 1 x USB 3.0 compliant)
- **Displays** 1 x VGA, supports 1920 x 1200 @ 60Hz 24bpp
1 x HDMI 1.4a, supports 1920 x 1080 @ 60Hz 24bpp
- **Audio** Line-Out
- **Power Connector** 1 x 4 Pins, Terminal Block to support dual power input
- **Grounding Protection** Chassis Grounding

Digital I/O

- **4-ch digital input** Wet/dry contact with Isolation Protection 2,500 V_{dc}
- **4-ch digital output** Compatible 5 V/TTL, Capable Sink: 24 mA max. per channel

Environment

- **Operating Temperature** - 20 ~ 60°C (-4 ~ 140°F) @ 5 ~ 85% RH with 0.7m/s airflow (Industry SSD)
- **Storage Temperature** - 40 ~ 85°C (-40 ~ 185°F)
- **Relative Humidity** 95% RH @ 40°C, non-condensing
- **Shock Protection** Operating, IEC 60068-2-27, 50G, half sine, 11ms
- **Vibration Protection** Operating, IEC 60068-2-64, 1Grms, random, 5 ~ 500Hz, 1 hr/axis
- **Ingress Protection** IP40

Application Software

SUSIAccess	Version : V2.1 or above An innovative remote device management software, allowing efficient remote monitoring, quick recovery & backup, and real-time remote configuration, to create a more intelligent and interconnected embedded computing solution.
WebAccess	Version : V7.1 or above WebAccess, as the core of Advantech's IoT solution, is full web browser-based software package for HMI and SCADA software. All HMI and SCADA software features including: Animated Graphics Displays, Real-time Data, Control, Trends, Alarms and Logs, are available in a standard web browser. WebAccess is built around the latest internet technologies. With its open architecture, vertical domain applications can easily be integrated.
PANEL EXPRESS <small>Designed for Convenience</small>	Version : V2.0.3.8 or above Panel Express, a windows based HMI mini SCADA, realizes the cross platform flexibility offered by WebOP Designer to switch hardware for the consideration of cost and performance become an easy job. Panel Express software provides the best economic and express solution for data intensive high-end HMI applications.
WebOP Designer	Version : V2.0.3.8 or above An easy to use integrated development tool featuring solution-oriented screen objects, high-end graphics, Windows fonts for multi-language applications. WebOP runtime, a part of WebOP Designer, guarantees reliability and performance because of the minimum system overhead, high communication data rates, and sub-second screen switching.

Dimensions

Unit: mm

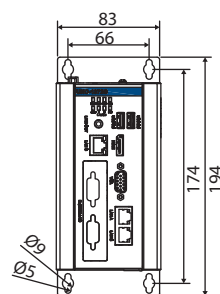
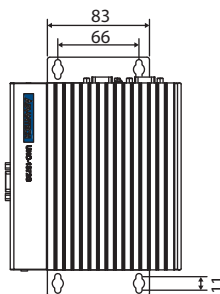
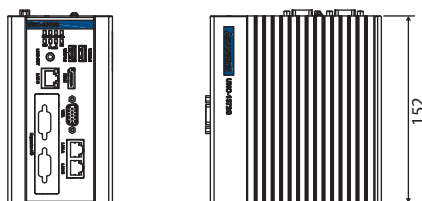
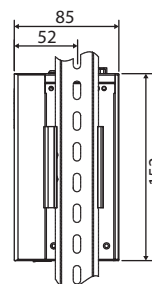
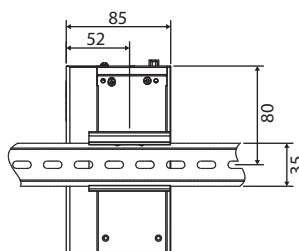
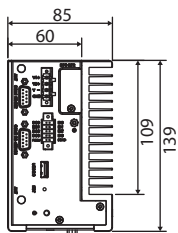

Front I/O View

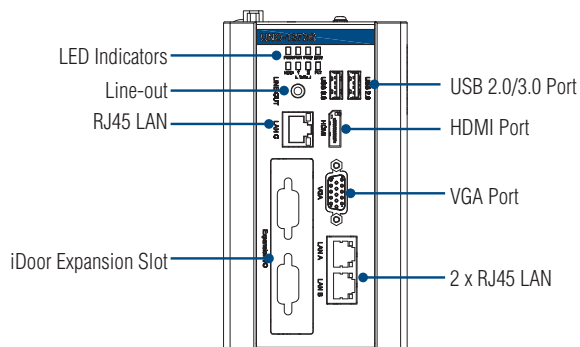

Top I/O View

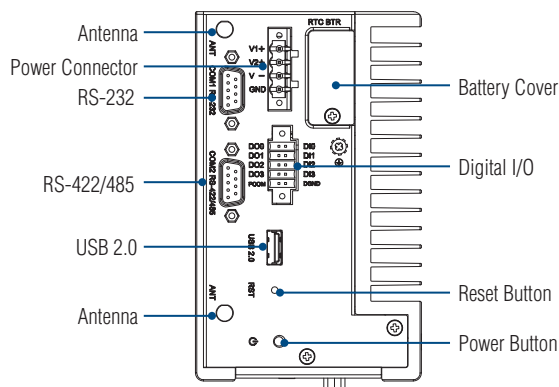

Ordering Information

- UNO-1372G-E3AE Intel Atom Quad-Core 1.91GHz, 4GB, 3 x LAN, 2 mPCIe, iDoor

iDoor Modules

- PCM-23C1CF-AE 1 CFast Slot with Cover Protection
- PCM-23U1DG-AE USB Slot w/ Lock for USB Dongle
- PCM-24R2GL-AE 2-Port Gigabit Ethernet, mPCIe, RJ45
- PCM-24U2U3-AE 2-Port USB 3.0, mPCIe, USB-A type
- PCM-24D2R4-AE 2-Port Isolated RS-422/485 mPCIe, DB9
- PCM-24D4R4-AE 4-Port Non-Isolated RS-422/485 mPCIe, DB37
- PCM-24S2WF-AE WiFi 802.11 a/b/g/n 2T2R w/ Bluetooth4.0, Half-size mPCIe, 2-port SMA
- PCM-24S23G-AE Wide-Temp 3.75G HSPA and GPS, 2-in-1, Full-size mPCIe w/ Redundant SIM Card holder, 2-port SMA
- PCM-26R2PN-MAE 2-Port Hilscher netX100 FieldBus mPCIe, PROFINET, RJ45, Master
- PCM-26R2PN-SAE 2-Port Hilscher netX100 FieldBus mPCIe, PROFINET, RJ45, Slave
- PCM-26D1DB-MAE 1-Port Hilscher netX100 FieldBus mPCIe, PROFIBUS, DB9, Master
- PCM-26D1DB-SAE 1-Port Hilscher netX100 FieldBus mPCIe, PROFIBUS, DB9, Slave

Accessories

- 1757002321 63WC to DC UNO series power adapter (Industrial Grade)
- PWR-249-AE 65W AC to DC power adapter (Commercial Grade)
- 1702002600 Power Cable US Plug 1.8 M (Industrial Grade)
- 1702002605 Power Cable EU Plug 1.8 M (Industrial Grade)
- 1702031801 Power Cable UK Plug 1.8 M (Industrial Grade)
- 1700000596 Power Cable China/Australia Plug 1.8 M (Industrial Grade)
- 1700001524 Power Cable 3-pin US type 1.8 M (Commercial Grade)
- 170203183C Power Cable 3-pin EU type 1.8 M (Commercial Grade)
- 170203180A Power Cable 3-pin UK type 1.8 M (Commercial Grade)

Embedded OS & Automation Software

- 2070013467 Image WES7P X64 MUI. for UNO-1372G
- 2070013468 Image Linux for UNO-1372G
- 968WEXP003X PanelExpress V2.0 300 tags S/W license
- 968WEXP015X PanelExpress V2.0 1500 tags S/W license
- 968WEXP050X PanelExpress V2.0 5000 tags S/W license