

UC-8580 Series Quick Installation Guide

Edition 3.0, October 2017

Technical Support Contact Information **www.moxa.com/support**

Moxa Americas:

Toll-free: 1-888-669-2872

Tel: 1-714-528-6777

Fax: 1-714-528-6778

Moxa China (Shanghai office):

Toll-free: 800-820-5036

Tel: +86-21-5258-9955

Fax: +86-21-5258-5505

Moxa Europe:

Tel: +49-89-3 70 03 99-0

Fax: +49-89-3 70 03 99-99

Moxa Asia-Pacific:

Tel: +886-2-8919-1230

Fax: +886-2-8919-1231

Moxa India:

Tel: +91-80-4172-9088

Fax: +91-80-4132-1045

MOXA[®]

© 2017 Moxa Inc. All rights reserved.

P/N: 1802085800011



Overview

The UC-8580 Series computer is a programmable communication-centric gateway offering a rich variety of communication interfaces, such as Ethernet, serial, and digital inputs/outputs. This EN 50155-compliant computer is built for rail applications and comes with multiple wireless WAN gateway interfaces, making it an ideal choice for building wireless communication infrastructure with 802.11 a/b/g/n/ac and for LTE data collection and transmission.

Model Names and Package Checklist

The UC-8580 Series consists of the following models:

Antenna Connector Type	Model Name	Operating Temperature	Conformal Coating
SMA	UC-8580-LX	-25 to 55°C (-13 to 131°F)	-
	UC-8580-T-LX	-40 to 70°C (-40 to 158°F)	-
	UC-8580-T-CT-LX	-40 to 70°C (-40 to 158°F)	✓
QMA	UC-8580-Q-LX	-25 to 55°C (-13 to 131°F)	-
	UC-8580-T-Q-LX	-40 to 70°C (-40 to 158°F)	-
	UC-8580-T-CT-Q-LX	-40 to 70°C (-40 to 158°F)	✓

The UC-8580 Series computer is shipped with the following items:

- UC-8580 Series computer
- CBL-4PINDB9F-100: 4-pin pin header to DB9 female console port cable, 100 cm
- Quick installation guide (printed)
- Warranty card

Appearance

The UC-8580 comes in two different front-panel models to support the two different types of antenna connectors (SMA and QMA) for wireless modules. The GPS antenna connector is secured to the front panel by default. The SMA model uses the SMA connector for all antennas while the QMA model uses a TNC connector for the GPS antenna and QMA connectors for all other antennas.

Front View

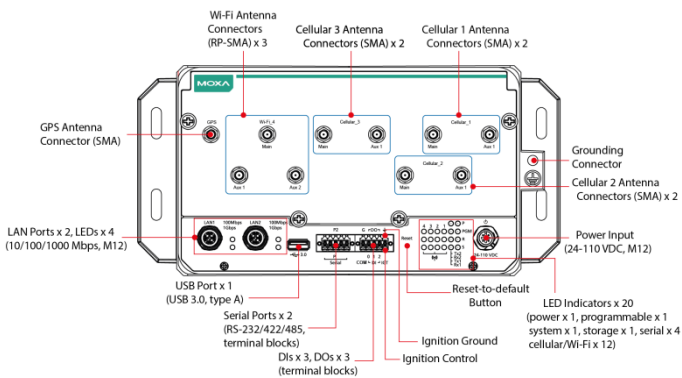

SMA Model

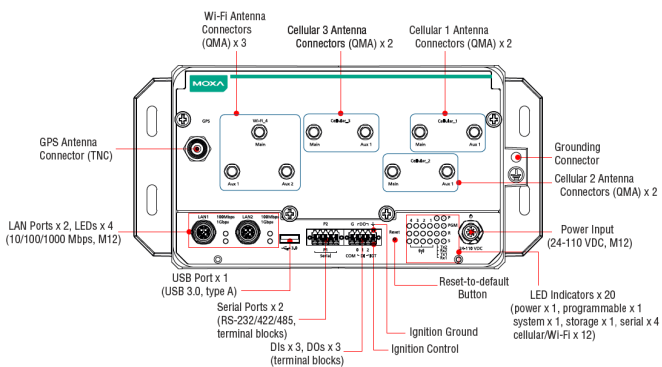

QMA Model

LED Indicators

Refer to the following table for the LED indicator definitions.

LED Name	Status	Function
P	Green	Power is on
	Off	No power input or any other power-input error
R	Green	System is ready
	Off	System is booting up, OS boot-up failure, or any other system initialization error
Ethernet (located next to the Ethernet ports)	Green	Steady On: 100 Mbps Ethernet link Blinking: Data transmission is in progress
	Yellow	Steady On: 1000 Mbps Ethernet link Blinking: Data transmission is in progress
	Off	Data transmission speed at 10 Mbps or the data cable is not connected
Serial	Green	Tx: Data transmission is in progress
	Yellow	Rx: Receiving data

LED Name	Status	Function
<ul style="list-style-type: none"> Tx2 Rx2 Tx1 Rx1 	Off	No operation on the serial ports
S	Green	Data is being accessed from either the eMMC or the mSATA module
	Off	No data is being accessed
PGM	Red	Programmable LED for user-defined function
Wireless 	Green	The number of glowing LEDs indicate the wireless signal strength as follows: 3 Green: Excellent 2 Green: Good 1 Green: Poor
	Off	No wireless signal

Installing the Computer

Wall or Cabinet Mounting

Use two screws per side to mount the UC-8580 computer on a wall or in a cabinet. The illustration below shows an SMA model.

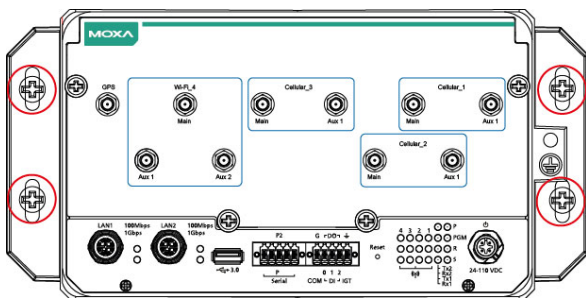

Wiring Requirements

Be sure to read and follow these common safety precautions before proceeding with the installation of any electronic device:

- Use separate paths to route wiring for power and devices. If power wiring and device wiring paths must cross, make sure the wires are perpendicular at the intersection point.

NOTE Do not run signal or communication wiring together with power wiring in the same wire conduit. To avoid interference, wires with different signal characteristics should be routed separately.

- Use the type of signal transmitted through a wire to determine which wires should be kept separate. The rule of thumb is that wiring that shares similar electrical characteristics can be bundled together.
- Keep input wiring and output wiring separate.
- It is advisable to label the wiring to all devices in the system.



ATTENTION

Safety First!

Be sure to disconnect the power cord before installing and/or wiring your UC-8580 computer.

Wiring Caution!

Calculate the maximum possible current in each power wire and common wire. Observe all electrical codes dictating the maximum current allowable for each wire size. If the current goes above the maximum ratings, the wiring could overheat, causing serious damage to your equipment.

Temperature Caution!

Be careful when handling the unit. When the unit is plugged in, the internal components generate heat, and consequently the outer casing may feel hot to the touch.

Connecting the Power

Connect the 24 to 110 VDC power line with M12 A-coded connector to the UC-8580 computer. If the power is supplied properly, the "P" LED will glow a solid green after a 25 to 30-second delay. The power input location and pin definition are shown in the following figures. The illustration below shows an SMA model:

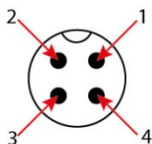

PIN	Definition
1	V+
2	N.C.
3	V-
4	N.C.

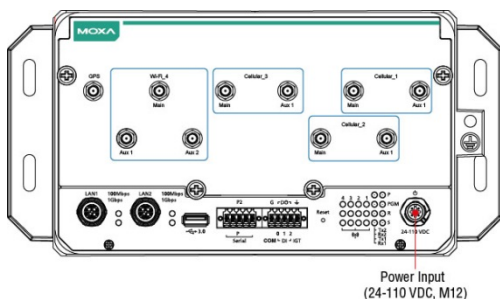

Grounding the Unit

Grounding and wire routing help limit the effects of noise due to electromagnetic interference (EMI). Run the ground connection from the ground screw to the grounding surface prior to connecting the power.

Please note that this product is intended to be mounted on a well-grounded mounting surface, such as a metal panel. The grounding connected is provided and located on the front panel. Connect the grounding wire to an appropriate grounded metal surface.

Grounding
Connector

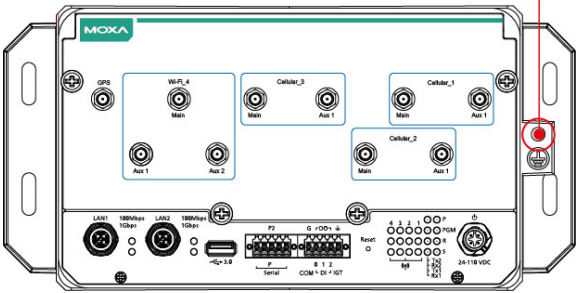

SMA Model

Connecting to the Network

The pin assignments for the UC-8580 computer's Ethernet port are shown in the following figure. If you are using your own Ethernet cable, make sure that you match the pin assignment on the connector of the Ethernet cable to the pin assignment shown below. The illustration below shows an SMA model.

PIN	Definition
1	DA+
2	DA-
3	DB+
4	DB-
5	DD+
6	DD-
7	DC-
8	DC+

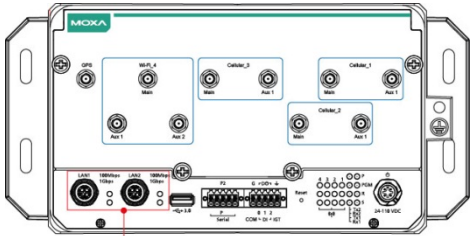

LAN Ports x 2, LEDs x 4
(10/100/1000 Mbps, M12)

Connecting a Serial Device

Use a serial cable to connect your serial device to the computer's serial port. Serial ports P1 and P2 use terminal blocks and can be configured for RS-232, RS-422, or RS-485 communication. The pin location and assignment are shown in the following diagrams. The illustration below uses an SMA model.

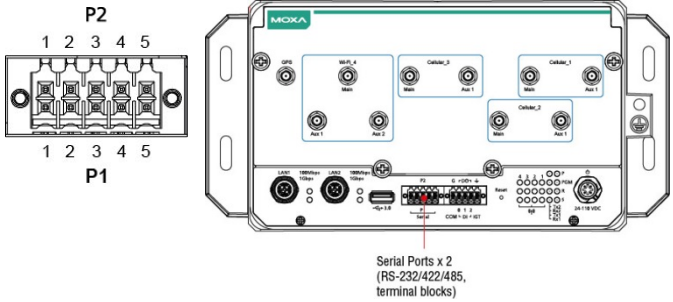

Pin	1	2	3	4	5
RS-232	TxD	RxD	RTS	CTS	GND
RS-422	TxD+	TxD-	RxD+	RxD-	GND
RS-485	-	-	DATA+	DATA-	GND

Connecting Digital Input/Output Devices

The UC-8580 computer comes with a 3-channel digital input and a 3-channel digital output terminal block that you can use to connect your digital devices. The DI/O pin assignments and wiring methods are shown below. The illustration below uses an SMA model:

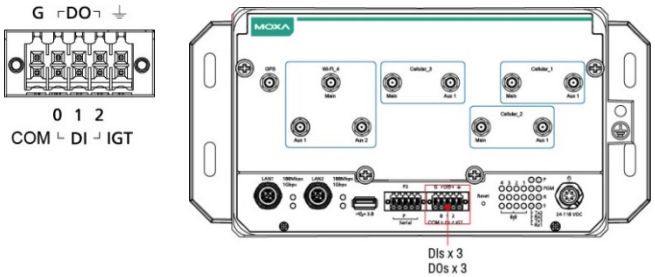

DI Dry Contact

DI Wet Contact

DO Contact Sink

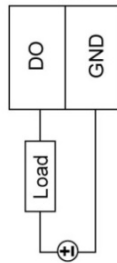
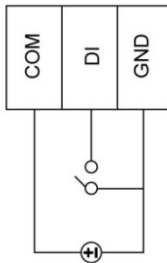
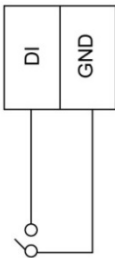

Connecting a USB Device

The UC-8580 computer is provided with a USB 3.0 port on the front panel for connecting a USB device. The illustration below shows an SMA model.

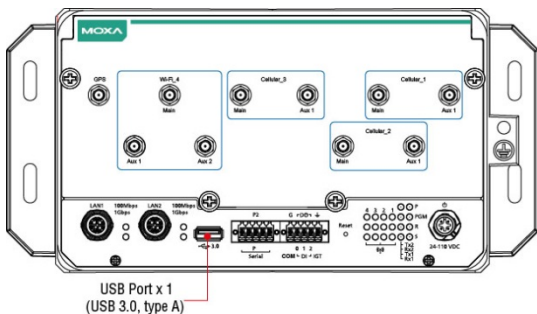

Connecting the Wi-Fi/Cellular Module and Antenna

The UC-8580 computer is provided with four sets of antenna holes for installing antennas for the Wi-Fi and cellular modules. Unfasten the four screws on the front panel and lift up the panel to check the location of the Wi-Fi/cellular module sockets. The illustration below shows an SMA model.

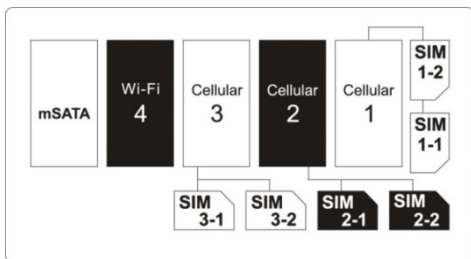
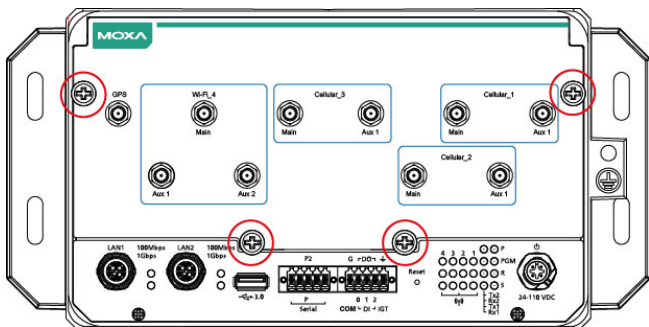

Socket Name	Usage
Cellular_1	Cellular module
Cellular_2	Cellular module
Cellular_3	Cellular module
Wi-Fi_4	Wi-Fi module

You will need to install the SIM cards for the cellular modules in the designated SIM-card slots. For the cellular module in socket 1, insert SIM cards in the SIM 1-1 and SIM 1-2 slots. The SIM cards for the cellular module in socket 3 should be inserted in the SIM 3-1 and SIM 3-2 slots.

The Wi-Fi/cellular module package includes 1 wireless (Wi-Fi or cellular) module, 2 or 3 antenna cables and connectors, 1 black tape, 1 tag sheet, 2 screws, 2 locking washers, and 2 nuts.

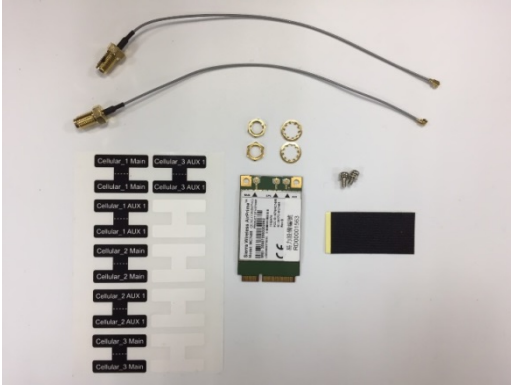

Accessories for the SMA Model

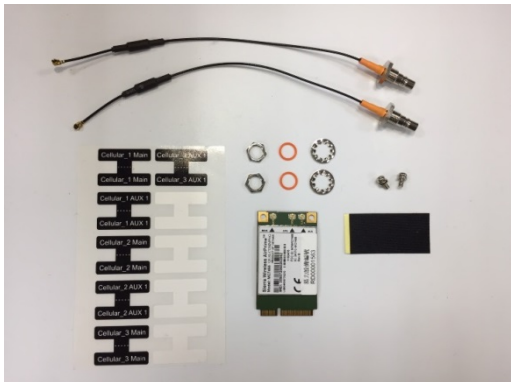

Accessories for the QMA Model

To install a wireless (Wi-Fi/cellular) module, do the following:

1. Remove the plastic protective film on the thermal pads attached to the wireless module.
2. Insert the wireless module in the designated socket and tighten the two screws on the module.

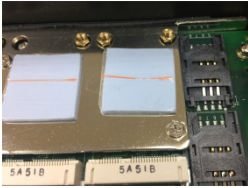

3. Attach the flat end of an antenna cable to the connector marked MAIN on the module and insert the other end of the cable (with the connector tube) into the antenna hole marked MAIN on the front panel of the computer. You must first remove the black cover on the antenna hole and insert the connector tube through the back side of the front panel before you can attach the antenna cable. Follow the procedure described above to attach the AUX antenna cable.



4. Use the black tape provided in the package to secure the antenna cables to the module. Attach tags (also provided in the package) to the cables as shown in the picture below so that you can identify them.

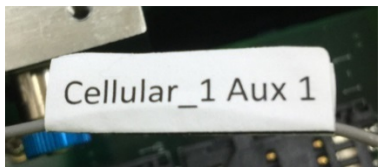

5. Insert the antenna connectors through the D-shaped antenna holes on the front panel. Be sure to align the D shape of the connector tube with the antenna holes before you do so.

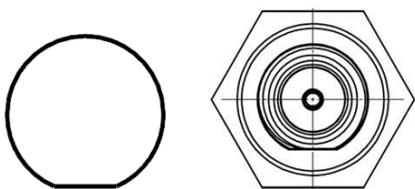

Secure the antenna connectors to the front panel by inserting the locking washers through the connector tube followed by the nut and then tightening the nut onto the threaded protection ring.

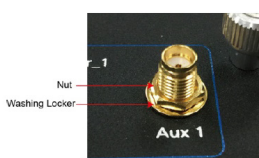

SMA Model QMA Model

6. Connect the antennas to the connectors on the front panel. Refer to the following illustration of an SMA model for the specific location of each antenna connector, including a connector for a GPS antenna.

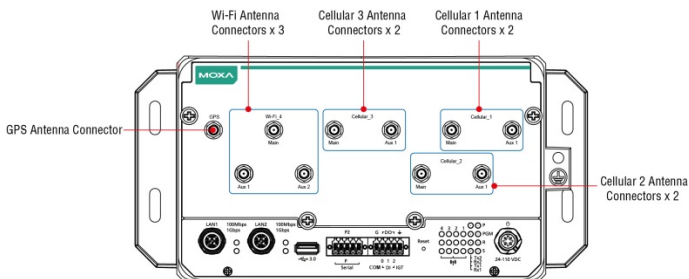

Use the procedure described above to install other Wi-Fi or cellular modules.

NOTE

1. The Wi-Fi module installed in socket 4 requires three antennas. Make sure all three antennas are installed and secured properly before you use the module.
2. The GPS antenna connector is installed and secured by default. The connector type used is SMA in UC-8580's SMA model and TNC in UC-8580's QMA model.

Installing SIM Cards

Each cellular module supports 2 SIM cards. To install SIM cards for the cellular modules, do the following:

1. Find the location of the SIM card socket.

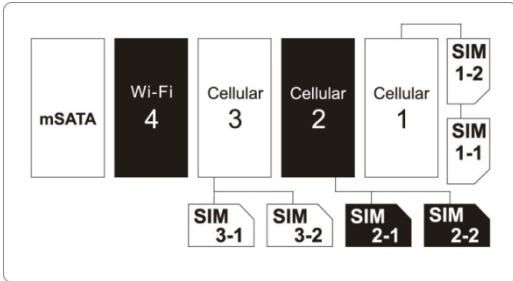

2. Pull up the SIM-card holder and insert the SIM card.



3. Push down the SIM-card holder until the SIM card is secured in place.

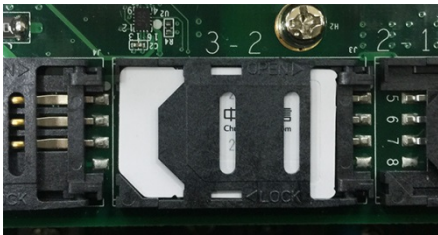

Installing the mSATA Module

The UC-8580 computer is provided with one storage socket for installing an mSATA module. To install the mSATA module, do the following:

1. Locate the mSATA socket.
It is the left most socket that you see when you open the front panel of the computer.
2. Insert the mSATA module onto the socket
3. Fasten the two screws on the module to secure the module.

