I-8124W

DeviceNet Master Module

User's Manual

Warranty

All products manufactured by ICP DAS are warranted against defective materials for a period of one year from the date of delivery to the original purchaser.

Warning

ICP DAS assumes no liability for damages consequent to the use of this product. ICP DAS reserves the right to change this manual at any time without notice. The information furnished by ICP DAS is believed to be accurate and reliable. However, no responsibility is assumed by ICP DAS for its use, or for any infringements of patents or other rights of third parties resulting from its use.

Copyright

Copyright 2010 by ICP DAS Co., LTD. All rights reserved worldwide.

Trademark

The names used for identification only may be registered trademarks of their respective companies.

Revision

Version	Firmware Version	Date	Author	Description
1.6	2.1	2021/ 10/04	Johney	Add new function 1. I8124_DisableKeepAliveMsg
1.5	1.8	2013/ 10/01	Johney	1. Update the CAN pin description and CAN bus wire connection.
1.4	1.8	2013/ 06/11	Johney	Add new function 1. I8124_GetAttributeW 2. I8124_SetAttributeW 3. I8124_SendExplicitMSG_W
1.3	1.7	2012 01/04	Johney	Fix function * I8124_ImportEEPROM
1.2	1.6	2011 01/10	Johney	Add new functions * I8124_ReadInputArea * I8124_WriteOutputArea * I8124_ReadbackOutputArea
1.1	1.0	2010 05/25	Johney	Update the CAN pin description
1.0	1.0	2010 03/28	Johney	This manual is for the I-8124W module.

Contents

REVISION	2
1. GENERAL INFORMATION	6
1.1 DEVICENET INTRODUCTION.....	6
1.2 DEVICENET APPLICATIONS	8
1.3 I-8124W WITH VENDOR'S DEVICENET SLAVES	9
1.4 I-8124W ARCHITECTURE.....	10
1.5 DEVICENET MASTER WORKING PROCEDURE.....	11
1.6 I-8124W FIRMWARE CHARACTERISTICS	14
1.7 FEATURES	16
1.8 BLOCK DIAGRAM.....	17
1.9 PRODUCT CHECK LIST	18
2. HARDWARE CONFIGURATION	19
2.1 BOARD LAYOUT	19
2.2 JUMPER SELECTION.....	20
2.3 CONNECTOR PIN ASSIGNMENT	21
2.4 WIRE CONNECTION	22
2.5 INDICATOR LED.....	24
2.5.1 NS LED (Red).....	24
2.5.2 RUN LED (Green)	24
2.5.3 MS LED (Yellow)	25
2.6 UPDATE THE I-8124W'S FIRMWARE	26
3. FLOW CHART FOR DEVICENET APPLICATION	29
3.1 FLOW CHART FOR SEARCHING DEVICES.....	31
3.2 FLOW CHART FOR SLAVE CONFIGURATION.....	32
3.3 FLOW CHART FOR ON-LINE ADDING/REMOVING DEVICE.....	33
3.5 FLOW CHART FOR "SETATTRIBUTE" AND "GETATTRIBUTE"	35
3.6 FLOW CHART FOR I/O CONNECTION	36
3.7 INPUT AND OUTPUT I/O DATA AREA (ADVANCED OPTION)	37
4. FUNCTION DESCRIPTION	40
4.1 DLL FUNCTION DEFINITION AND DESCRIPTION	41
4.2 FUNCTION RETURN CODE	45
4.3 FUNCTION DESCRIPTION	49

4.3.1	I8124_TotalI8124Module	49
4.3.2	I8124_ActiveModule	50
4.3.3	I8124_CloseModule	51
4.3.4	I8124_GetDLLVersion	52
4.3.5	I8124_GetFirmwareVersion	53
4.3.6	I8124_ResetFirmware	54
4.3.7	I8124_GetMasterMACID	55
4.3.8	I8124_SetMasterMACID	56
4.3.9	I8124_GetBaudRate	57
4.3.10	I8124_SetBaudRate	58
4.3.11	I8124_GetMasterStatus	59
4.3.12	I8124_GetSlaveStatus	60
4.3.13	I8124_StartDevice	61
4.3.14	I8124_StopDevice	62
4.3.15	I8124_StartAllDevice	63
4.3.16	I8124_StopAllDevice	64
4.3.17	I8124_AddDevice	65
4.3.18	I8124_RemoveDevice	66
4.3.19	I8124_AddIOConnection	67
4.3.20	I8124_RemoveIOConnection	68
4.3.21	I8124_GetAttribute	69
4.3.22	I8124_GetAttributeW	70
4.3.23	I8124_IsGetAttributeOK	71
4.3.24	I8124_GetAttributeValue	72
4.3.25	I8124_SetAttribute	73
4.3.26	I8124_SetAttributeW	74
4.3.27	I8124_IsSetAttributeOK	75
4.3.28	I8124_ClearAllConfig	76
4.3.29	I8124_SearchAllDevices	77
4.3.30	I8124_SearchSpecificDevice	78
4.3.31	I8124_IsSearchOK	79
4.3.32	I8124_GetSearchedDevices	80
4.3.33	I8124_GetDeviceInfoFromScanList	81
4.3.34	I8124_GetScanList	82
4.3.35	I8124_ImportEEPROM	84
4.3.36	I8124_ReadInputData	85
4.3.37	I8124_WriteOutputData	86
4.3.38	I8124_SendExplicitMSG	87

4.3.39	I8124_SendExplicitMSG_W	88
4.3.40	I8124_IsExplicitMSGRespOK	89
4.3.41	I8124_GetExplicitMSGRespValue	90
4.3.42	I8124_ReadbackOutputData	91
4.3.43	I8124_ReadInputArea (Advanced Option)	92
4.3.44	I8124_WriteOutputArea (Advanced Option)	94
4.3.45	I8124_ReadbackOutputArea (Advanced Option)	96
5.	<i>DNM_UTILITYCE FOR WP-8000</i>	99
5.1	<i>INTRODUCTION</i>	100
5.2	<i>TUTORIAL DEMOS</i>	101
5.2.1	Where to find the Hardware Information	101
5.2.2	How to start using the utility	102
5.2.3	How to search the slave devices	103
5.2.4	How to add I/O information into the EEPROM	105
5.2.5	How to remove I/O information from the EEPROM	106
5.2.6	How to read/write the I/O data form/to the slave device	107
5.3	<i>DESCRIPTION OF THE BUTTONS AND FIELDS</i>	109
5.3.1	Total Module Number	109
5.3.2	Slot Number	109
5.3.3	Active Module	109
5.3.4	Reset Firmware	109
5.3.5	Search All Device	109
5.3.6	Start All Device	110
5.3.7	Stop All Device	110
5.3.8	Clear All Device	110
5.3.9	Write Output Data	110
5.3.10	Change Master ID	111
5.3.11	Change Baud Rate	111
5.3.12	Firmware Version	111
5.3.13	Master Status	111

1. General Information

1.1 DeviceNet Introduction

The CAN (Controller Area Network) is a serial communication protocol, which efficiently supports distributed real-time control with a very high level of security. It is an especially suited for networking "intelligent" devices as well as sensors and actuators within a system or sub-system. In CAN networks, there is no addressing of subscribers or stations in the conventional sense, but instead, prioritized messages are transmitted. DeviceNet is one kind of the network protocols based on the CAN bus and mainly used for machine control network, such as textile machinery, printing machines, injection molding machinery, or packaging machines, etc. DeviceNet is a low level network that provides connections between simple industrial devices (sensors, actuators) and higher-level devices (controllers), as shown in Figure 1.1.

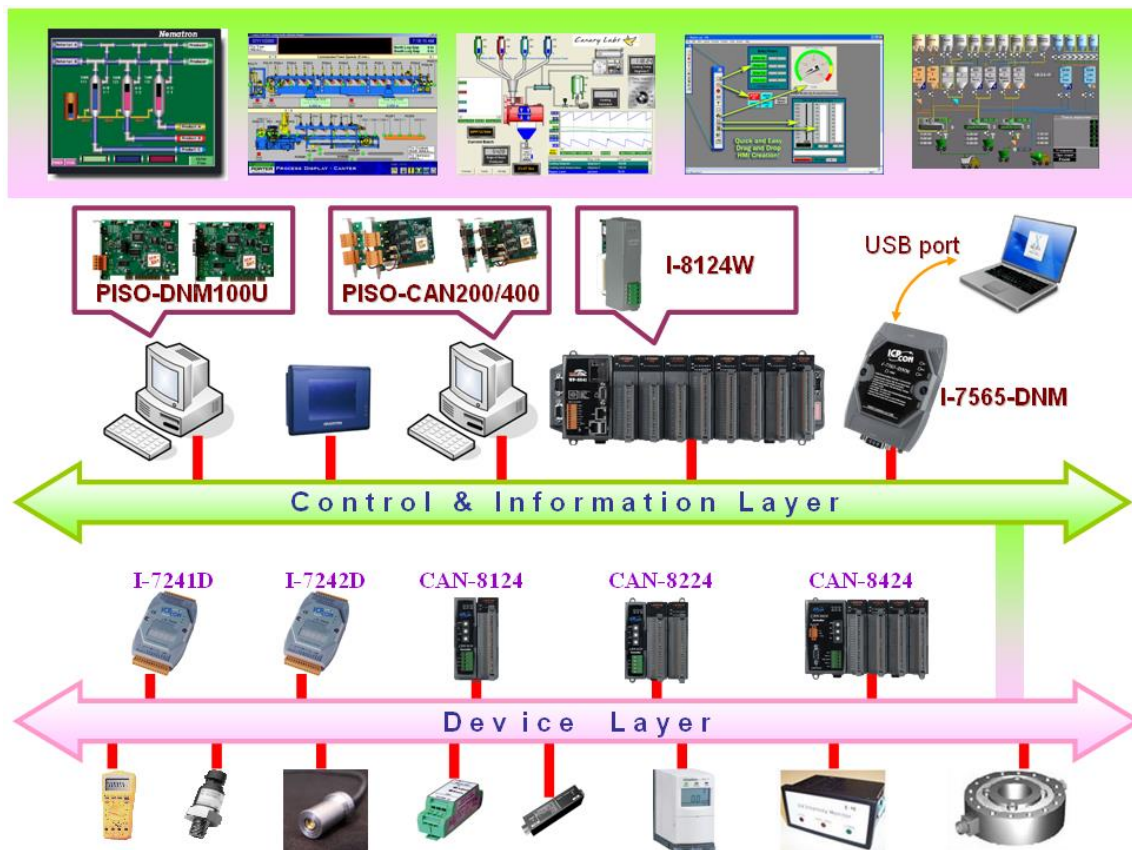

Figure 1.1 Example of the DeviceNet network

DeviceNet is a cost effective solution to one kind application of control area network. It reduces the connection wires between devices and provides rapid troubleshooting function. The transfer rate can be up to 500 kbps within 100 meters bus length. The transfer distance can be up to 500 meters in 125 kbps baud (See Table 1.1). It allows direct peer to peer data exchange between nodes in an organized and, if necessary, deterministic manner. Master/Slave connection model can be supported in the same network. Therefore, DeviceNet is able to facilitate all application communications based on a redefine a connection scheme. However, DeviceNet connection object strands as the communication path between multiple endpoints, which are application objects that is needed to share data.

Baud rate (bit/s)	Max. Bus length (m)
500 k	100
250 k	250
125 k	500

Table 1.1 The Baud rate and the Bus length

I-8124W is a DeviceNet master device on the DeviceNet network. It supports Group 2 only Server and UCMM functions to communication with slave devices. It has an CAN bus communication port with the ability to cover a wide range of DeviceNet applications because of the inside CPU. Besides, I-8124W uses the new CAN controller Phillips SJA1000T and transceiver 82C250, which provide bus arbitration, error detection with auto correction and re-transmission function. With WinPAC-8000, ViewPAC, and XPAC system, it is an economic and high performance solution of DeviceNet application. There are utility tool and demos for I-8124W to help you building your application quickly. Therefore, it is popularly applied in the industrial automation, building automation, vehicle, marine, and embedded control network.

1.2 DeviceNet Applications

DeviceNet is the standardized network application layer optimized for factory automation. It is mainly used in low-volume and mid-volume automation systems. Some users have also implemented DeviceNet in machine control systems. The main DeviceNet application fields include the applications shown below (For more information, please refer to www.odva.org):

- Production cell builds and tests CPUs
- Beer brewery
- Equipment for food packing
- Fiberglass twist machine
- Sponge production plant
- Isolation wall manufacturing
- Overhead storage bin production
- Pocket-bread bakery
- Dinnerware production
- HVAC module production
- Textile machines
- Trawler automation system
- LCD manufacturing plant
- Rolling steel door production
- Bottling line
- Tight manufacturing



1.3 I-8124W with Vendor's DeviceNet Slaves

We have communicated with the following DeviceNet slaves.

- Allen-Bradley [PowerFlex](#) series DeviceNet Inverters.
- BECKHOFF [CX1500-B520](#) series DeviceNet I/O modules.
- BECKHOFF [BK5250](#) series DeviceNet I/O modules.
- MKS [683](#) series DeviceNet exhaust throttles.
- MKS [MFC \(Mass Flow Controller\)](#) series DeviceNet devices.
- MKS [DELTA-II FRC \(Flow Ratio Controller\)](#) series DeviceNet devices.
- MKS [DC Power Generator \(OPT- xxx\)](#) series DeviceNet devices.
- OMRON [DRT1-ID/ODxx](#) series DeviceNet I/O modules.
- OMRON [DRT2-MDxx](#) series DeviceNet I/O modules.
- COSMOS [PS-7](#) series DeviceNet gas detectors.
- CELERITY [UNIT IFC-125](#) series DeviceNet devices.

1.4 I-8124W Architecture

The I-8124W provides the way to establish DeviceNet network rapidly by Master/Slave connection model. It is a high-performance DeviceNet master module with inside CPU. This architecture of the I-8124W only needs few resources of main control unit (such as WinPAC-8000, ViewPAC-8000, XPAC-8000 ...) and really increases the work efficiency on DeviceNet network. Applying the I-8124W, you don't need to take care of the detail of the DeviceNet protocol. The firmware implements the DeviceNet protocol to help you setting up the connection with DeviceNet slave devices easily. The illustration of the idea is shown as Figure 1.2.

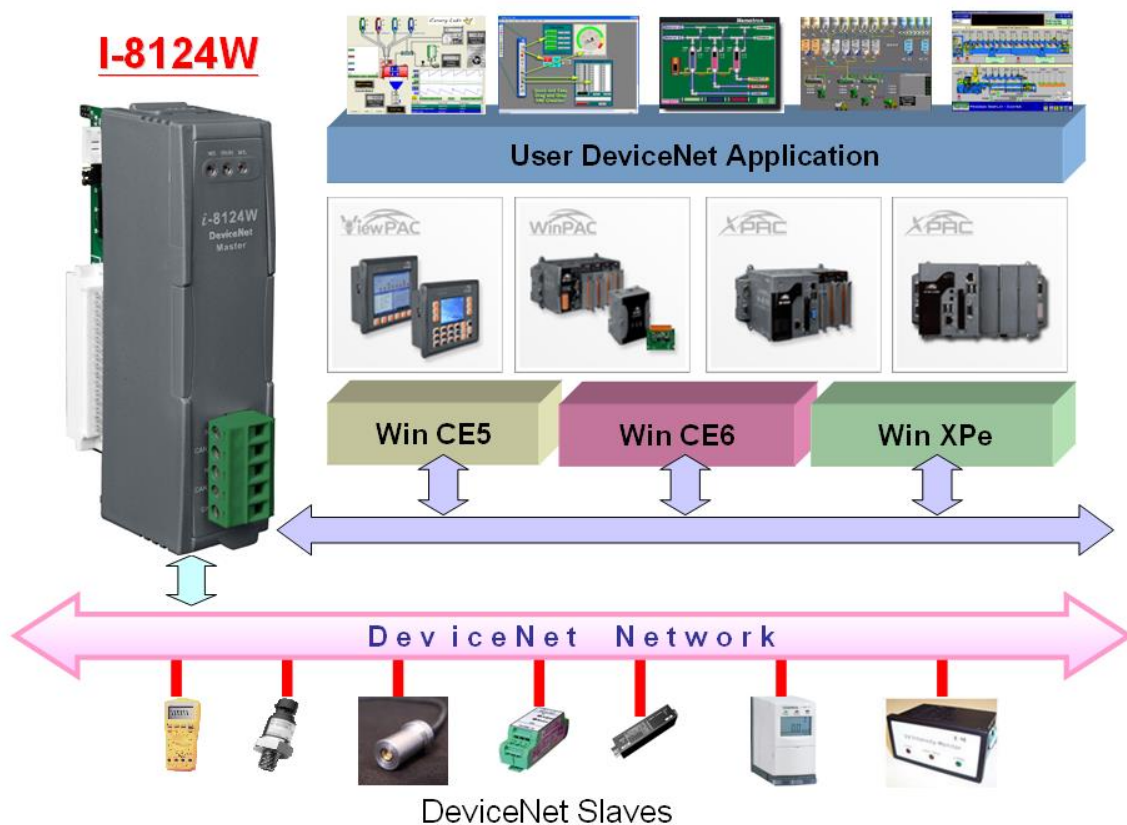

Figure 1.2 I-8124W architecture

1.5 DeviceNet Master Working Procedure

Using the API functions, users don't need to take care of the detail of the DeviceNet protocol. It can reduce the complexity of user's DeviceNet Master Software. The firmware mainly supports the Predefined Master-Slave Connection Set and UCMM functions to allow users to merge third party's DeviceNet devices into the DeviceNet network. It can help users establishing the connection with DeviceNet slave devices easily. The general application architecture is demonstrated as Figure 1.3.

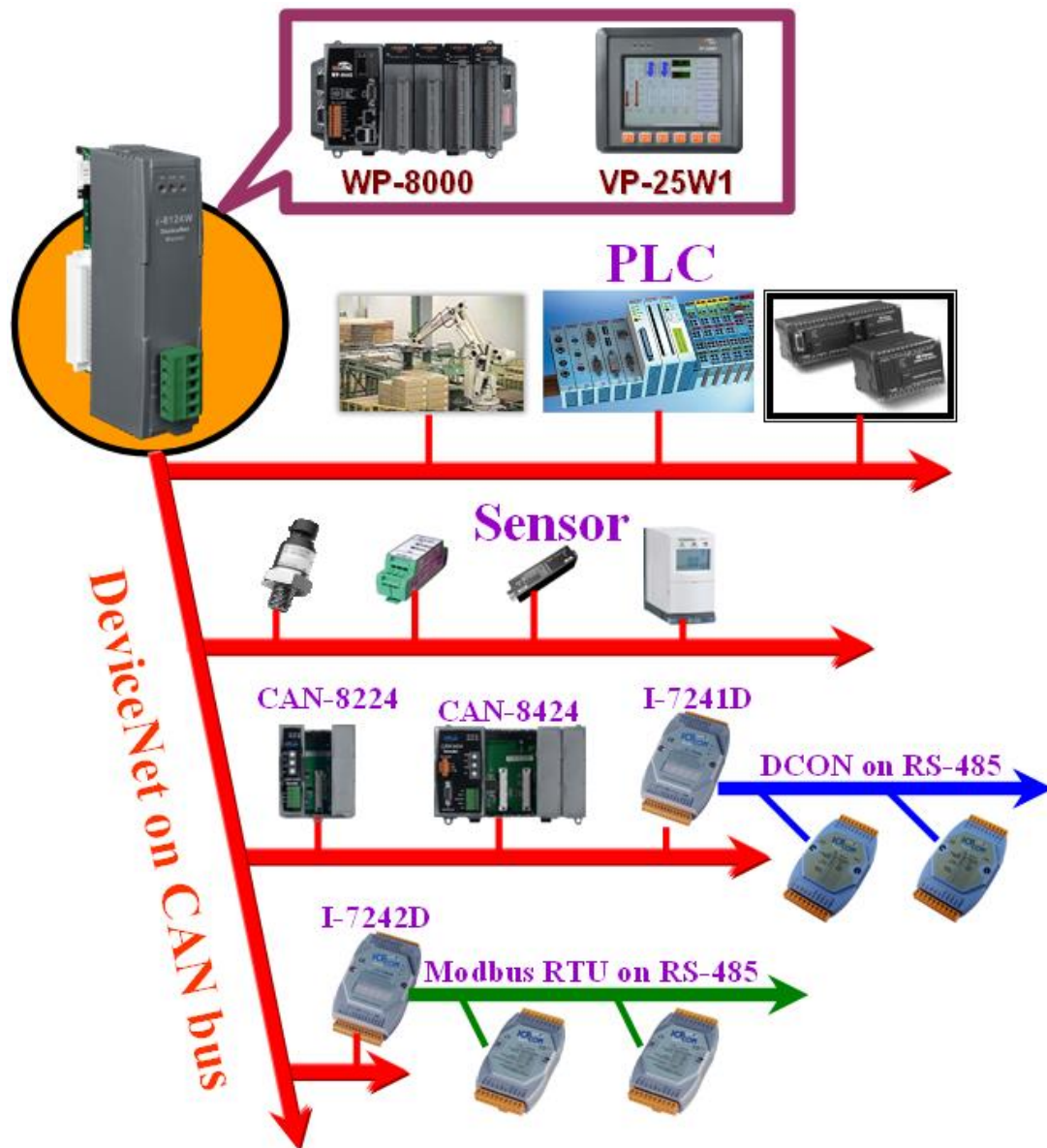

Figure 1.3 Application architecture

The firmware of I-8124W provides the DeviceNet Master mechanism to communicate with slave devices by the Predefined Master/Slave Connection Set and UCMM Connection Set. In the DeviceNet communication protocol can be clarify as two forms: Explicit Message and I/O Message. Here, we only provide one explicit message connection and 4 I/O connections as depicted in Figure 1.4.

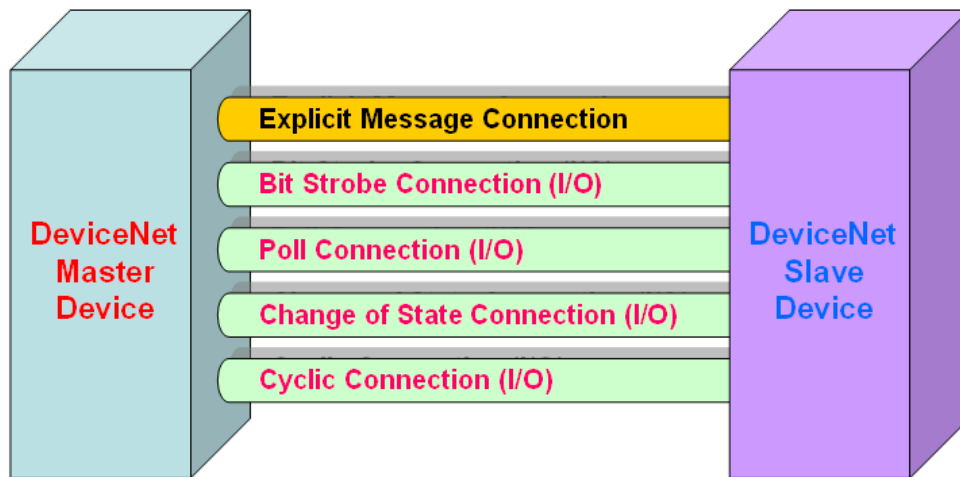

Figure 1.4 DeviceNet Messaging

The DeviceNet Communication Protocol is based on the concept of connections method. Master should create connections with slave devices based on the command of exchanging information and I/O data. To establish the master control mechanism, there are only 4 steps to be followed. Figure 1.5 demonstrates the basic process for the DeviceNet master communication. Each step is described in below:

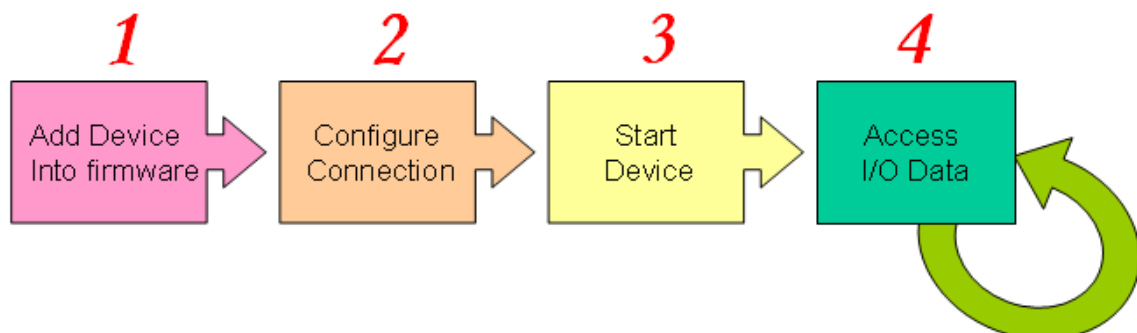

Figure 1.5 Four steps to establish connection

1. Add device into firmware

Add the slave device's MAC ID into firmware by using API function.

2. Configure connection

Check the slave device's I/O connection type and the I/O data length. While configuring the I/O connection, provide these parameters to configuration APIs.

3. Start Device

After configuring connections, the master will communicate with the slave device which is triggered to active by using API function.

4. Access I/O data

After communicating with slave devices, you can access the I/O data with corresponding read/write functions.

After adding the device into the firmware, the master will wait for users to get the I/O configuration information. Users can create the I/O connections in the next step. Once I/O connections have been created and activated, I/O data can be exchanged among devices in the DeviceNet network according to the requirement of the master device. The master device can access I/O data of the slave devices by one of the four I/O connection methods. All of the steps described above are implemented by API functions. The API functions are not only easy to use but also providing a lot of the DeviceNet Master functions to retrieve and deliver the I/O data of the slaves. For more information about APIs, please refer to functions description and demo programs in section 4.

1.6 I-8124W Firmware Characteristics

The I-8124W is a high-performance DeviceNet master module. In the I-8124W, there is a firmware which implements DeviceNet protocol automatically when it is active. The firmware always listens to the bus and receives the messages at the same time. It works as shown in Figure 1.6.

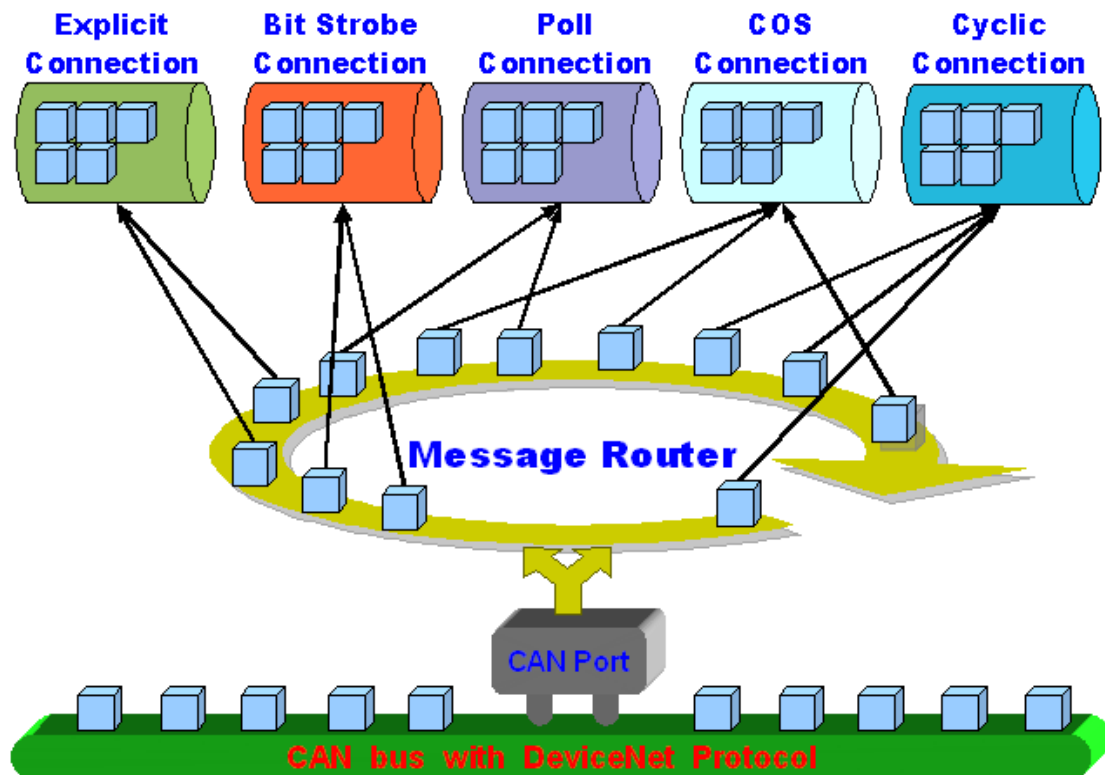

Figure 1.6 Message Router

The I-8124W firmware has a “ScanList” which is used for store the remote slave devices information. After adding or removing a slave device into firmware by APIs, the firmware will save immediately this information into “ScanList” and update the EEPROM information. You don’t need to reboot for this operation. When you reboot I-8124W next time, it will load the “ScanList” information from EEPROM again and run with the slaves by following the “ScanList” information. Users can easily use the DLL functions or Utility tools to configure it by calling “add device” or “remote device” functions. It works as following Figure 1.7.

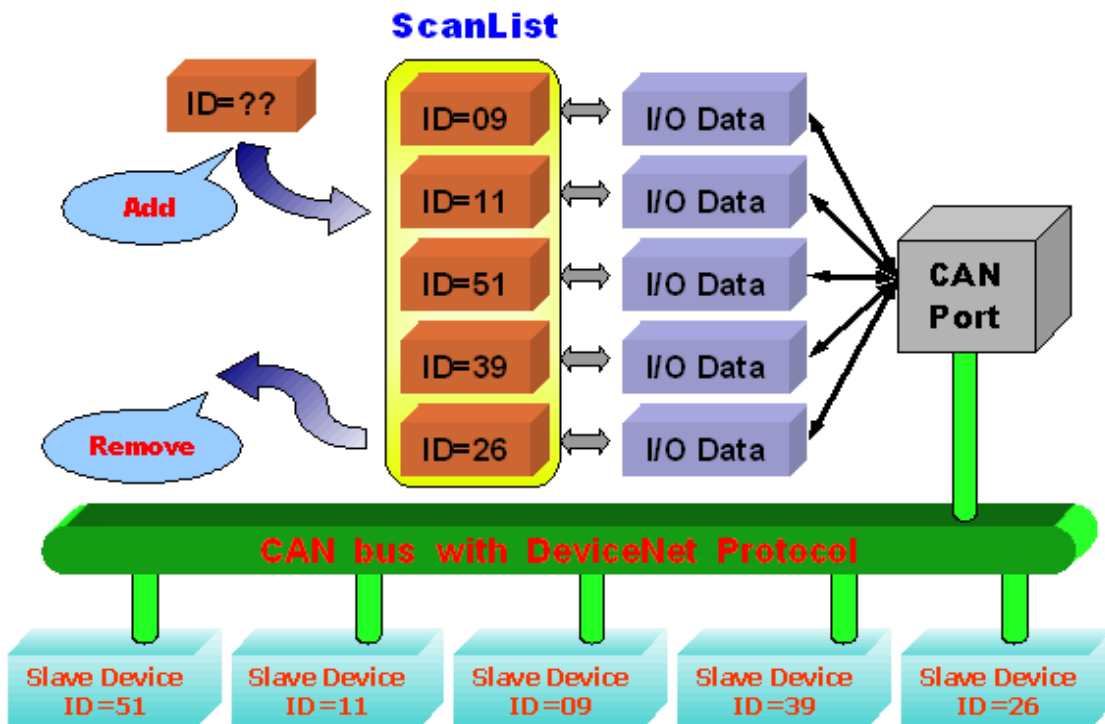

Figure 1.7 ScanList data structure

1.7 Features

Hardware Features

- CPU : 80186-80 MHz or compatible.
- CAN Port : 5-pin screwed terminal block (CAN_L, CAN_GND, CAN_H, N/A for others).
- CAN Controller : NXP SJA1000T with 16M Hz clock.
- CAN Transceiver : NXP 82C250.
- Isolation : 3000 VDC for DC-to-DC, 2500 Vrms for photo-couple.
- Specification : ISO-11898-2, CAN 2.0A and CAN 2.0B.
- 3 indicating LED (RUN, NS and MS).
- Terminator resistor : Switch select 120Ω terminator resistor.
- Power Consumption : 2W.
- Operating Temperature : -25 ~ 75°C
- Storage Temperature : -40 ~ 80°C
- Humidity : 5 ~ 95% RH, non-condensing
- Support PAC : ViewPAC, WinPAC, XPAC, XPAC-Atom series.

DeviceNet Firmware Features

- Programmable Master MAC ID.
- Programmable transfer-rate 125 kbps , 250 kbps, 500 kbps.
- Each port support maximum nodes up to 64
- Support Group 2 and UCMM functions
- Predefined Master-Slave Connection Set
- The maximum Fragment number is (Input/Output) up to 64
- Support I/O Operation Mode: Poll, Bit-Strobe and Change Of State/Cyclic
- Support Auto-Scan slave device function.
- Support on-line adding and removing devices.
- Support Auto-Reconnect when the connection is broken.

1.8 Block Diagram

1.8 Block Diagram

The figure 1.8 shows the block diagram of the I-8124W module.

1. DPRAM :

The DPRAM provides the communication channel between PAC (WP-8000 or XPAC-8000) and I-8124W module.

2. EEPROM :

The EEPROM stores the configuration information. While activating the I-8120W, the “ScanList” will be loaded from EEPROM automatically.

3. CPU :

This CPU is for implementing the DeviceNet protocol and communicating with the main control unit such as WP-8000 or XP-8000.

4. CAN Controller :

The CAN controller is used for sending and receiving the CAN messages. I-8120W provides the photo isolation function between CAN controller and CAN bus.

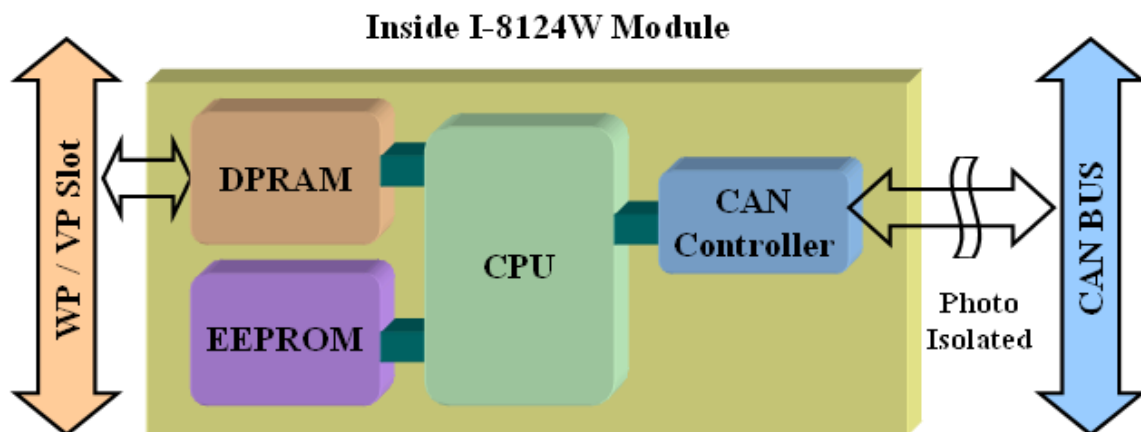

Figure 1.8 Block diagram of the I-8124W module

1.9 Product Check List

In addition to this manual, the package includes the following items:

- I-8124W module;
- Software CD ROM;
- Quick Start manual;
- Release Note

It is recommended that users should read the release note first. All of the important information needed will be provided in the release note as follows:

- Where you can find the software driver, utility and demo programs.
- How to install software & utility.
- Where is the diagnostic program.
- FAQ's and answers.

Attention !

If any of these items are missing or damaged, please contact your local field agent. Keep aside the shipping materials and carton in case you want to ship or store the product in the future.

2. Hardware Configuration

This section will describe the hardware settings of the I-8124W. This information includes the wire connection and terminal resistance configuration.

2.1 Board Layout

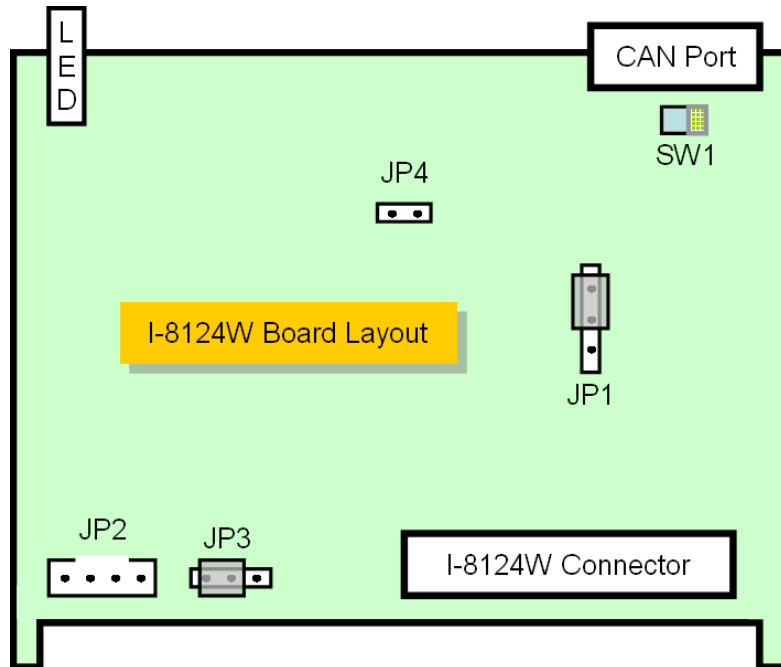

Figure2.1 I-8124W Board LAYOUT



2.2 Jumper Selection

The following table shows the definition of jumpers. Users need to refer to this table to configure the I-8124W hardware.

Jumper	Description	Status
JP1	Flash Protection. If you need to update the firmware, you should unlock it before you download the firmware. The default is lock.	<p>JP1</p>  <p>Lock Unlock</p>
SW1	CAN Port 120Ω terminal resistor.	<p>Resistor Switch</p>  <p>0 Ω 120 Ω</p>

Table 2.1 Jumper selections

2.3 Connector Pin Assignment

The I-8124W is equipped with one **5-pin screwed terminal connector** for wire connection of the CAN bus. The connector's pin assignment is specified as follows:

The 5-pin screwed terminal connector of the CAN bus interface is shown in Figure 2.5.

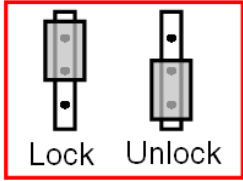
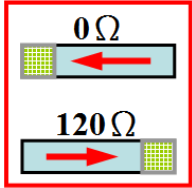
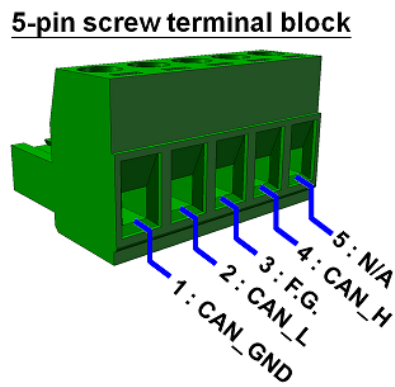

Figure2.5 5-pin screw terminal connector

2.4 Wire connection

In order to minimize the reflection effects on the CAN bus line, the CAN bus line has to be terminated at both ends by two terminal resistances as in the following figure. According to the ISO 11898-2 spec, each terminal resistance is 120Ω (or between $108\Omega\sim 132\Omega$). The length related resistance should have $70\text{ m}\Omega/\text{m}$. Users should check the resistances of the CAN bus, before they install a new CAN network.

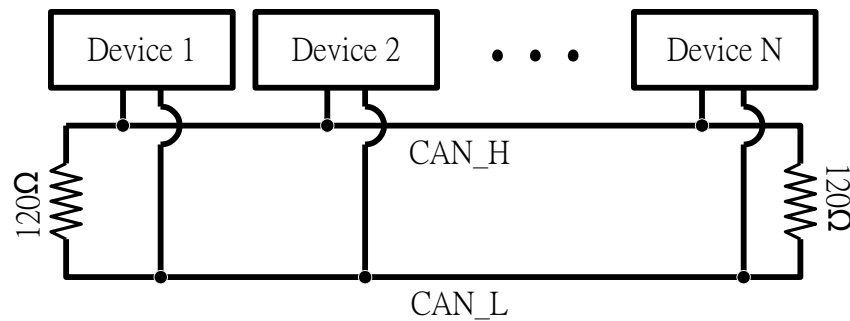

Figure 2.4 CAN bus network topology

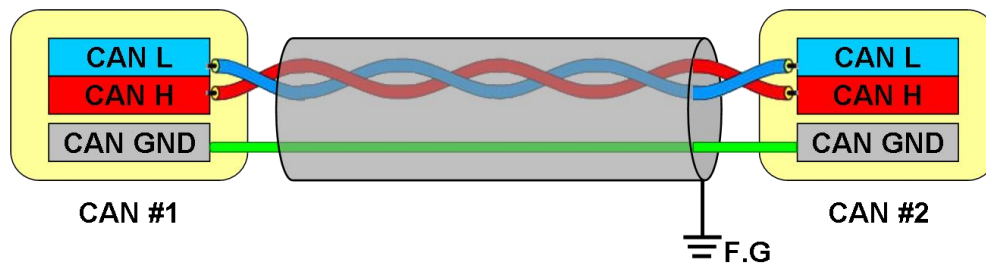

Figure 2.5 CAN bus wire connection without DC power

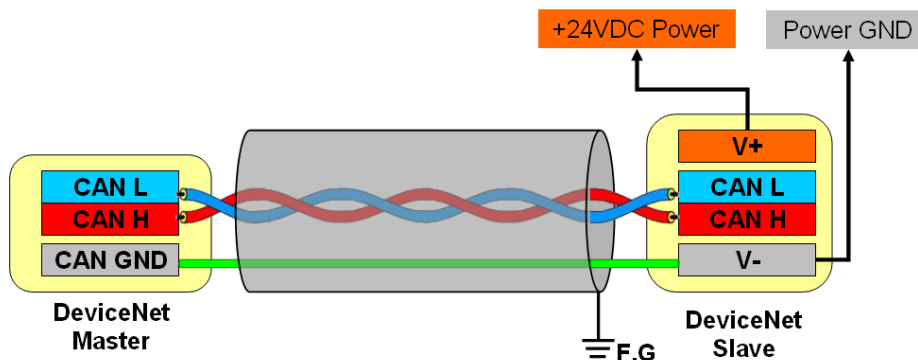

Figure 2.6 CAN bus wire connection with 24VDC power

Moreover, to minimize the voltage drop over long distances, the terminal resistance should be higher than the value defined in the ISO 11898-2. The following table can be used as a good reference.

Bus Length (meter)	Bus Cable Parameters		Terminal Resistance (Ω)
	Length Related Resistance (m Ω /m)	Cross Section (Type)	
0~40	70	0.25(23AWG)~ 0.34mm ² (22AWG)	124 (0.1%)
40~300	< 60	0.34(22AWG)~ 0.6mm ² (20AWG)	127 (0.1%)
300~600	< 40	0.5~0.6mm ² (20AWG)	150~300
600~1K	< 20	0.75~0.8mm ² (18AWG)	150~300

Table 2.4 Relationship between cable characteristics and terminal resistance

2.5 Indicator LED



2.5.1 NS LED (Red)

The “NS” means Network Status. It presents the error status of the network. If some error occurs on the bus or the MAC ID of any slave conflicts with the one of the I-8124W, the NS LED will flash. There are two situations in NS LED.

(1). LED off:

There is no bus error or MAC ID conflict.

(2). LED twinkle (Red) :

Some error occurs. The situations may be shown below:

- (a) The I-8124W doesn't connect any slave device with CAN bus.
- (b) The slave devices maybe out of order or have wrong configuration.
- (c) The MAC ID collision between master and slave devices is detected.

2.5.2 RUN LED (Green)

The RUN LED presents the firmware status of I-8124W. There are three situations in RUN LED.

(1). LED off :

Some error happens on the bus or in the I-8124W module. The DeviceNet firmware doesn't work.

(2). LED twinkle (Green) :

This indicates that the CAN bus works well. But there is no slave device configured in the EEPROM of I-8124W. The DeviceNet firmware is waiting for configuration. Users can use APIs or utility tool to add or remove the slaves in the “ScanList”.

(3). LED solid on (Green) :

This indicates that the DeviceNet firmware is running. The I-8124W module is communicating with all the slave devices normally.

2.5.3 MS LED (Yellow)

The MS LED shows the module status. It indicates that at least one slave devices disconnecting with the I-8124W. There are two situations in MS LED.

(1). LED off :

This shows that all of the slave devices communicate with the I-8124W normally.

(2). LED twinkle (Yellow) :

This shows that at least one slave device has problem to communicate with I-8124W. It may occur if the configuration is wrong or the slave device is malfunction.

2.6 Update the I-8124W's firmware

Generally, it is not necessary to update the firmware of I-8124W. If you need some special functions or there is a bug in firmware, it may be needed. When users want to download the new firmware into the I-8124W, they could achieve it by the following description.

A. Preparing the I-8120W Software Utility. (i8120w_utility.exe)

The users could download form the FTP below.

For WinCE 5

ftp://ftp.icpdas.com/pub/cd/fieldbus_cd/can/slotmodule/i_8120w/tools/wince5/

For WinCE 6

ftp://ftp.icpdas.com/pub/cd/fieldbus_cd/can/slotmodule/i_8120w/tools/wince6/

For XPe

ftp://ftp.icpdas.com/pub/cd/fieldbus_cd/can/slotmodule/i_8120w/tools/xpe/

B. Preparing the new I-8124W firmware. (8124Vxx.exe) (xx is version No.)

The users could download form the FTP below.

ftp://ftp.icpdas.com/pub/cd/fieldbus_cd/devicenet/master/i-8124w/firmware/

C. Configuring the jumpers of I-8124W

The users should unlock the flash protection jumper shown below.

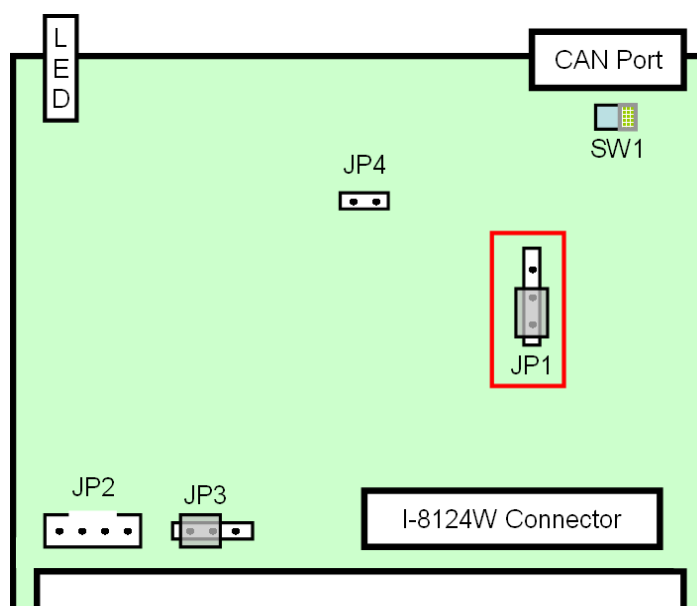

D. Updating the firmware.

(1) Open the i8120w_utility

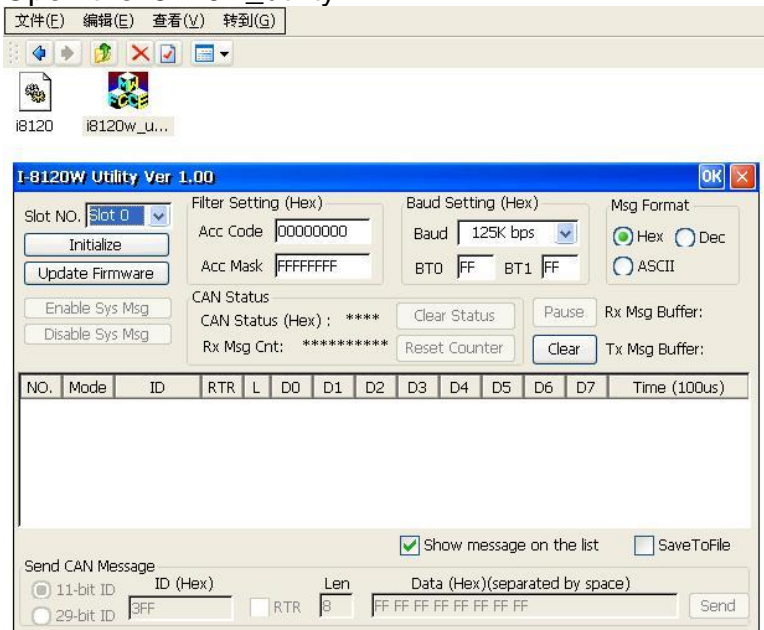

(2) Select the slot number which the I-8124W plugged in.

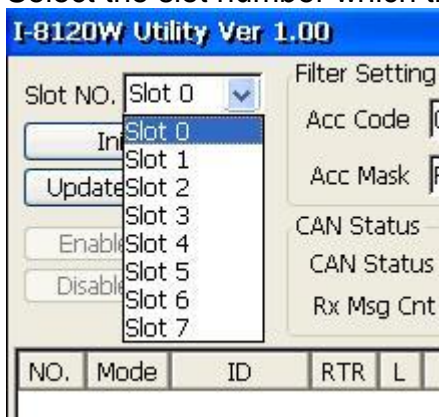

(3) Click the “Update Firmware” button.

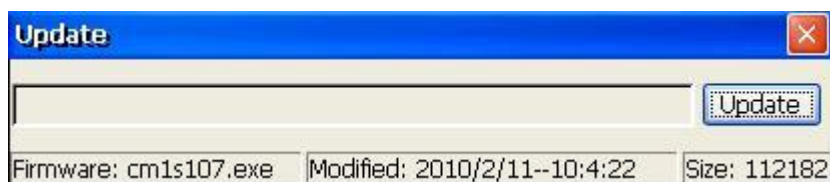

(4) Click the “Update” button to select the I-8124W firmware.



(5) Click “OK” button to start downloading the firmware.



E. Configuring the jumpers of I-8124W again

The users should lock the flash protection jumper shown below.

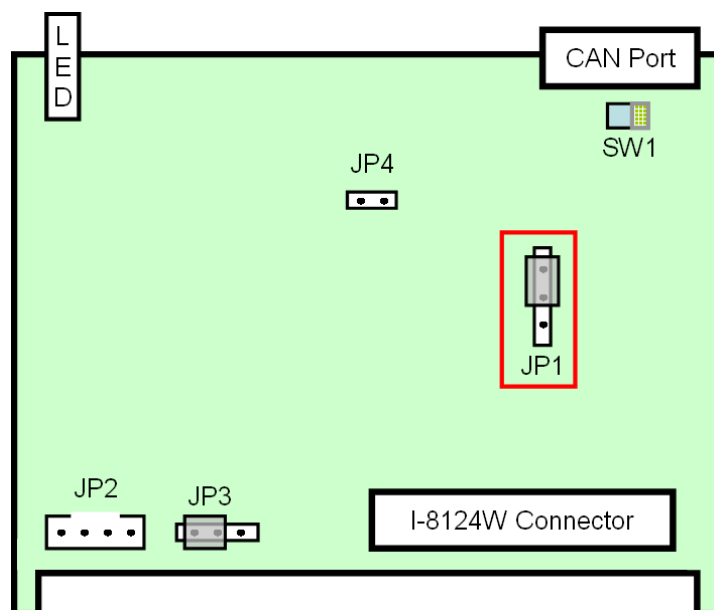

3. Flow Chart for DeviceNet Application

It is important to understand the sketch development flow. Here shows the overall flow chart for utilizing the I-8124W.

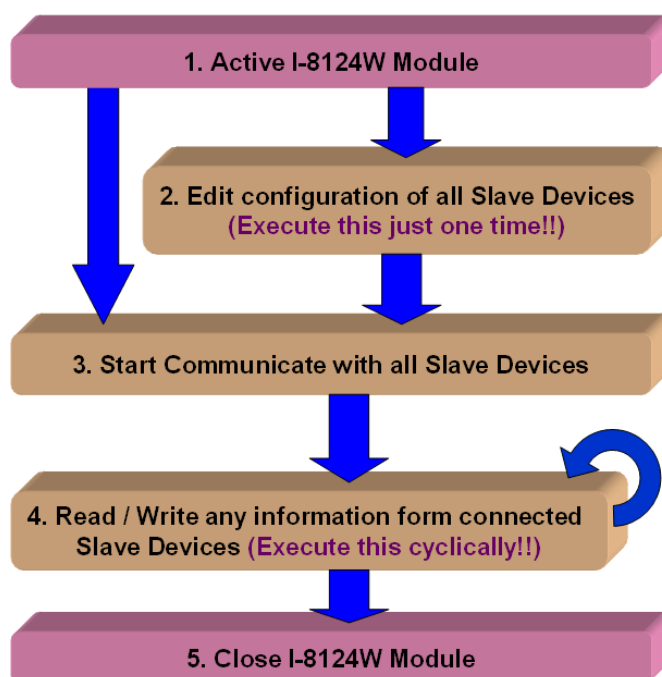

Figure 3.1 Sketch Flow Chart

1. Active I-8124W Module

Before using the I-8124W, the users should activate it. There is an API which is I8124_ActiveModuel to achieve this. The detail about this function is described in the next chapter.

2. Edit configuration of all Slave Devices

It is necessary to provide all slave information to the I-8124W. There are two methods to provide the data. One is that search all the slave devices by the DNM_UtilityCE.(Ch5) The other is that calling the corresponding APIs to add the devices which are like I8124_Add... and I8124_Remove...There are more description in the next chapter.

By the way, there is important information. Finish editing the slave information, the users need not to edit again by using these APIs like I8124_Add... and I8124_Remove... This information already saved in the I-8124W's EEPROM. Even if the users power off the WinPAC or ViewPAC or XPAC controller, the information still exists.

3. Start Communicate with all Slave Devices

This step is to make the I-8124W to start communicating with all slave devices which have been saved in the EEPROM. The I-8124W would act a DeviceNet master to “talk” to all slave devices. The corresponding APIs are I8124W_StartAllDevice and I8124W_StartDevice. Refer to the next chapter.

4. Read / Write any information from connected Slave Devices

After communicating with all slave devices, the users could read or write the I/O data form the slave devices. For further purpose, the users also could get or set the attribute information form the slave devices. The users could use software timer or thread to read the latest I/O data or attribute form the remote slave devices cyclically. Continue this chapter, you would learn more details.

5. Close I-8124W Module

If the users need to close the application for any purpose, it is important to close the I-8124W module by calling the I8124_CloseModule. This would make the I-8124W to stop working. Refer to the description in the next chapter for more details.

3.1 Flow Chart for Searching Devices

Before developing the DeviceNet applications, users should diagnose the connection among the slave devices. First, users can search the slave devices in the network by using the searching function of the APIs. If the connection among the master and other slave devices is good, users can find the information of each slave device in the same DeviceNet network. When users have no idea about how to find the slave devices by I-8124W, the following steps in the figure 3.2 is good reference. The users could take advantage of the searching function to check the connection status of all slave devices. The detail about these functions is described in the next chapter.

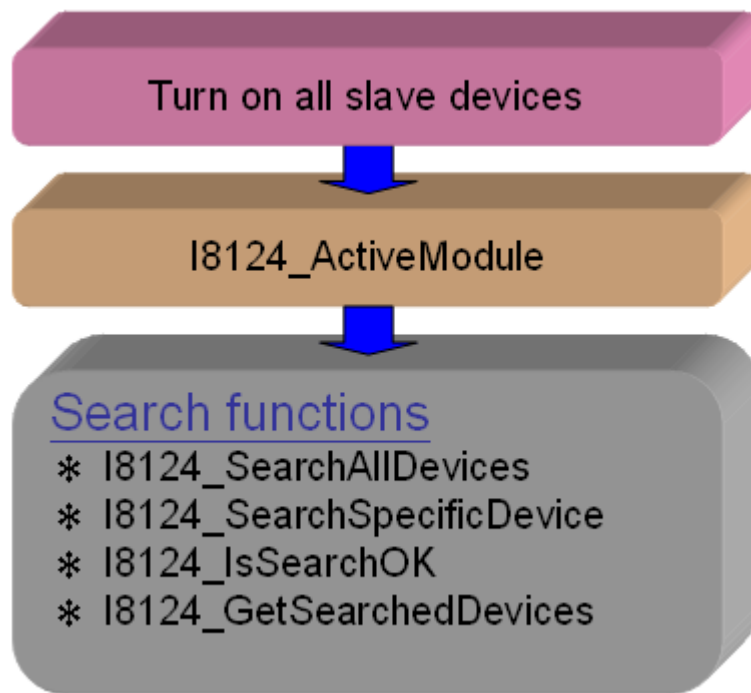

Figure 3.2 Searching Flow Chart

3.2 Flow Chart for Slave Configuration

After getting the DeviceNet I/O information of the slave devices by the APIs or the utility tool, the information needs be saved into the EEPROM of the I-8124W. The users could follow the flow chart to save the parameters into the EEPROM of the I-8124W module. The firmware in the I-8124W module will load the previous configuration from the EEPROM in the next boot-up. When the arrangement of the devices in the DeviceNet network is changed, users must reconfigure to fit the application. The configuration flow chart is shown in Figure 3.3. More information about these functions is presented in the next chapter.

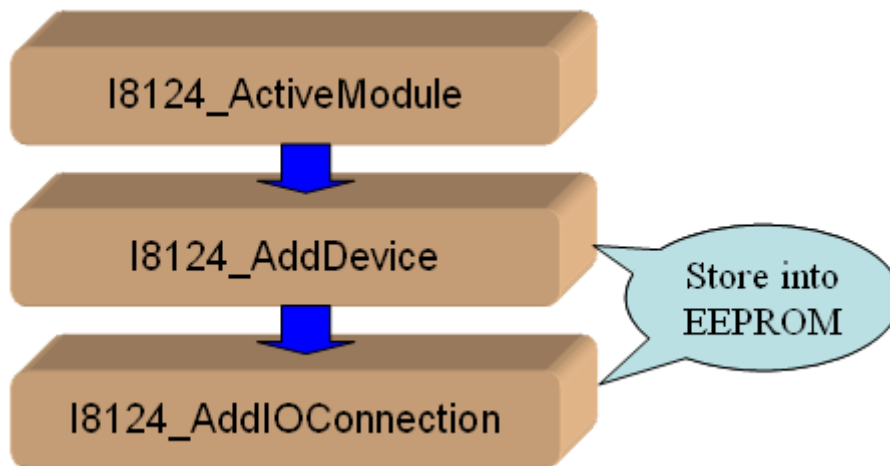

Figure 3.3 Slave Configuration Flow Chart

3.3 Flow Chart for On-line Adding/Removing Device

I-8124W provides the on-line adding/removing slave device functions. Users don't need to break the communication of the slave devices when adding or removing the slave devices. Follow the steps to achieve this function. The steps are shown in Figure 3.6 and Figure 3.7.

1. On-line Adding Devices :

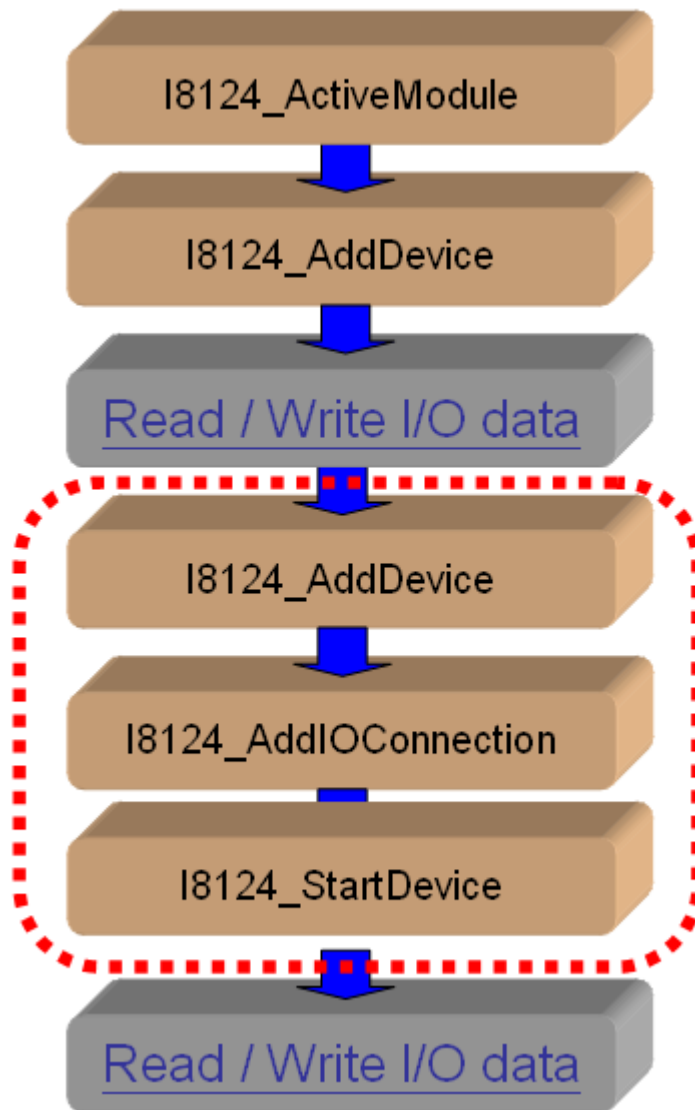

Figure 3.6 On-line Add Device Flow Chart

2. On-line Removing Devices :

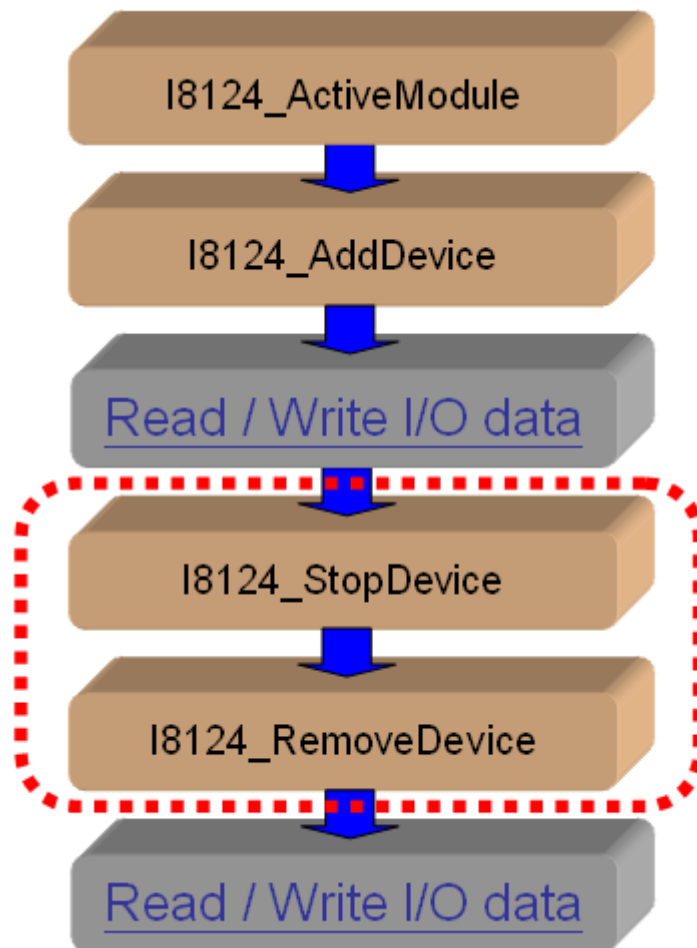

Figure 3.7 On-line Remove Device Flow Chart

3.5 Flow Chart for “SetAttribute” and “GetAttribute”

Users can set or get the DeviceNet properties of the slaves via the DeviceNet network. I-8124W provides these functions to set or get these properties easily. The steps are shown in Figure 3.8.

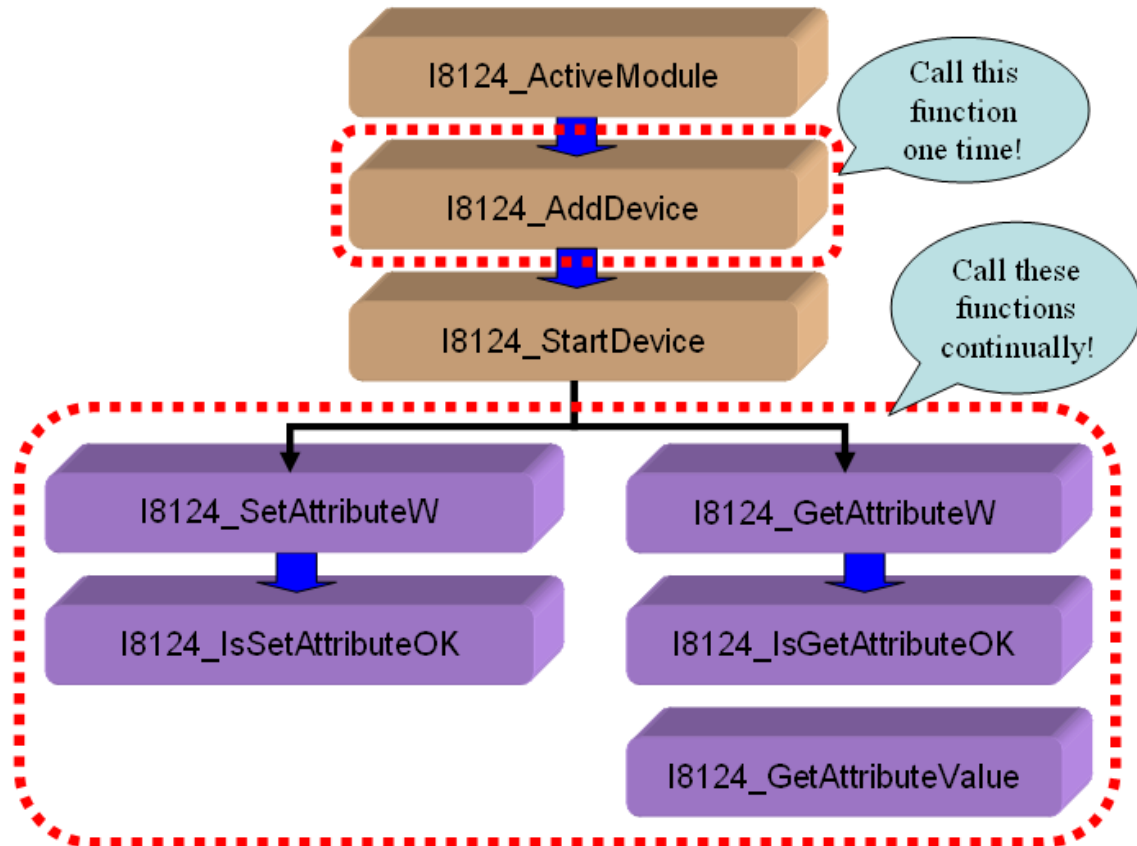

Figure 3.8 “SetAttribute” and “GetAttribute” Flow Chart

3.6 Flow Chart for I/O Connection

The users can read or write device's I/O data via the DeviceNet I/O connections such as Poll, Strobe, COS and Cyclic connection. There are four important steps to read and write the I/O data. Firstly, users should know the device's I/O input length (in Byte) and output length (in Byte). Secondly, users should set these two parameters to the slave device by calling I8124_AddI/OConnection. Thirdly, users can set the initial output value by calling I8124_WriteOutputData before starting the specific slave device. If users do not initialize the output value, the firmware default output value is 0. Finally, users can start communicating with the slave devices to read or write I/O data. If the specific slave device doesn't have any output channel, the firmware will start communicating with the device automatically. The Figure 3.9 shows the main steps how to achieve this. More functions are described in chapter 4.

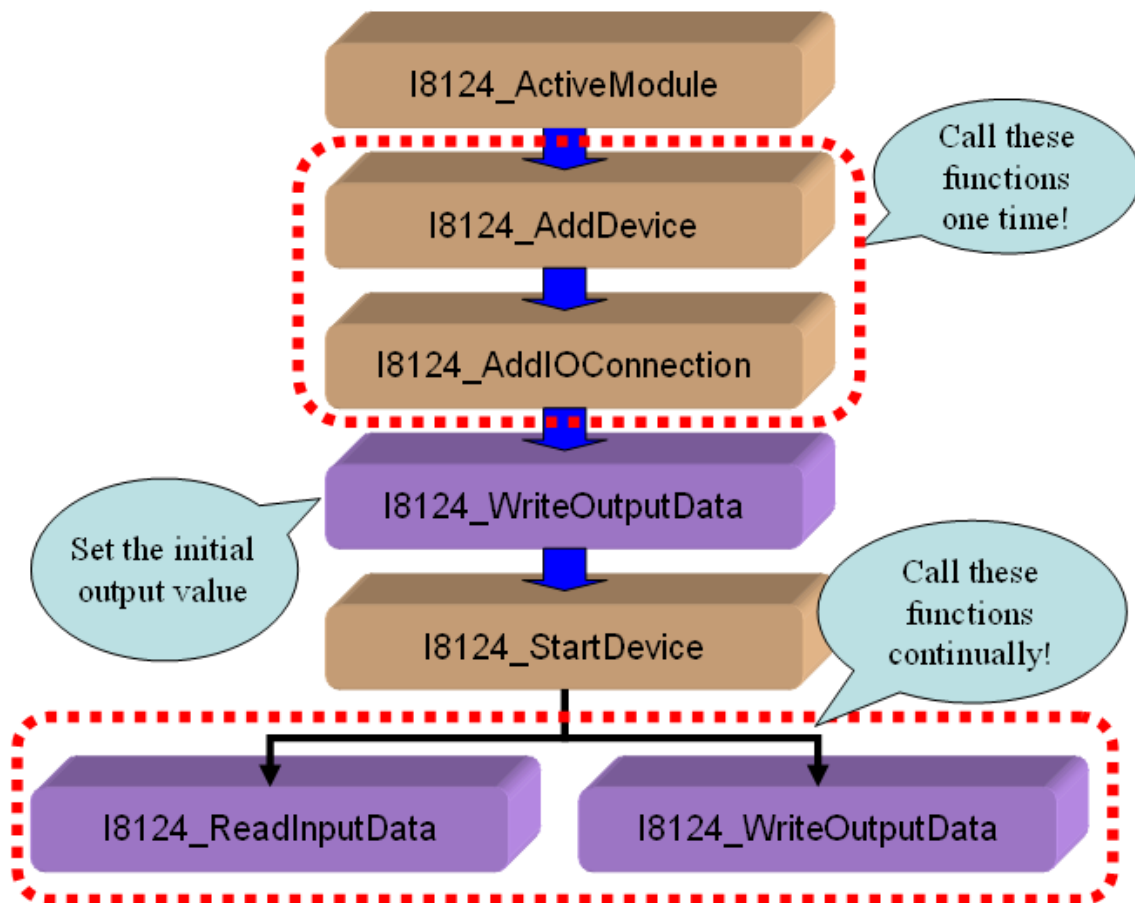

Figure 3.9 I/O Connection Flow Chart

Note: The Strobe connection doesn't support the output channel. Users can not use the I8124_WriteOutputData with Strobe connection.

3.7 Input and Output I/O Data Area (Advanced Option)

Here exist two memory areas, “Remote Input Area” and “Remote Output Area”. The input data of all DeviceNet slaves would be stored in the “Remote Input Area”, and the output data of them would be in the “Remote Output Area”. Please refer to the Figure 3.10.

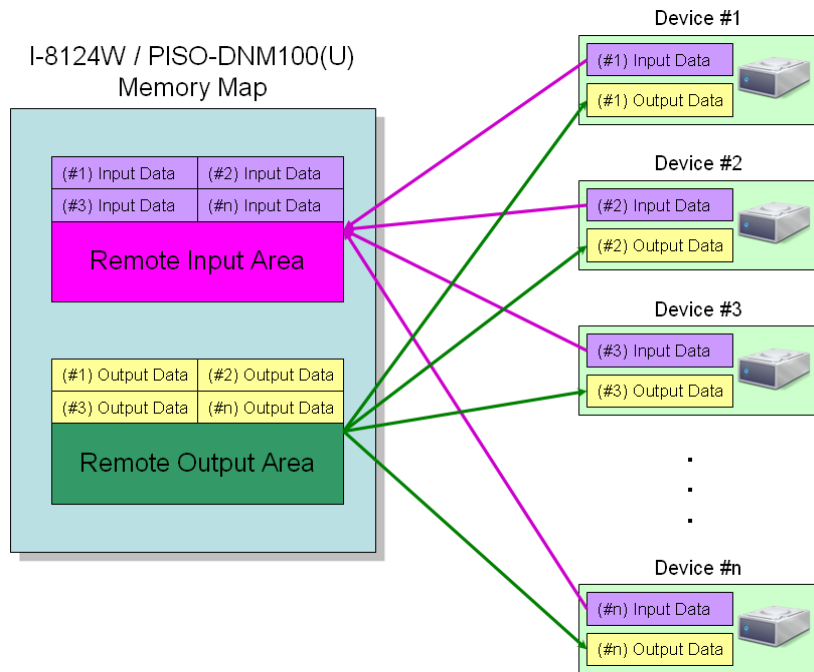

Figure 3.10 The Memory Mapping of the I-8124W

Users can read a bulk data from “Remote Input Area” in the I-8124W. This bulk data contains multiple devices’ input statuses. If one of the input status of the remote DeviceNet slave changes, the corresponding data located in the “Remote Input Area” would change immediately. Oppositely, the “Remote Output Area” contains multiple devices’ output data. Users may change the output value of a certain device by changing the corresponding data located in the “Remote Output Area”.

There is another important thing. Users need to know what the arrangement of those data. The data of the slave with the smallest DeviceNet MAC ID would be located in the most front of the Remote Input/Output Area. The data of the slave with the following MAC ID would be located in the following section, and so on. The data of the slave with the largest MAC ID would be located in the last section of the Remote Input/Output Area. Here shows three examples about the arrangement rule of the I-8124W.

Example 1 :

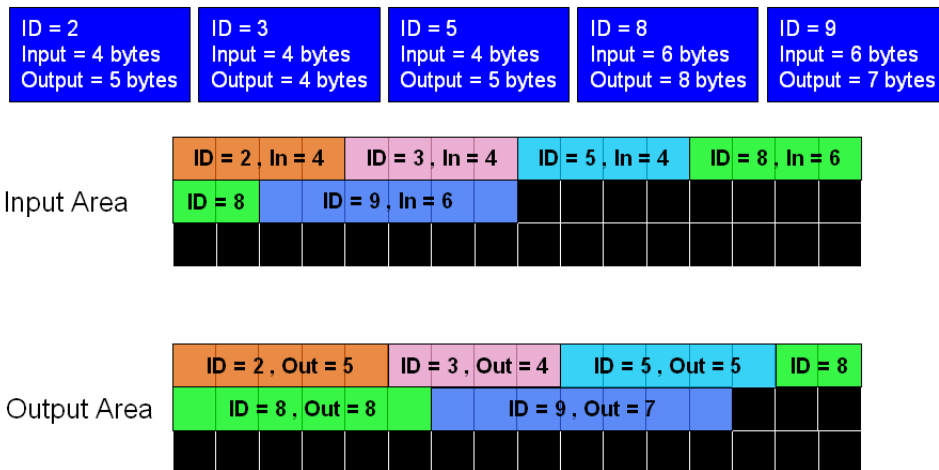

Figure 3.11 The example of the I-8124W memory mapping

Example 2 :

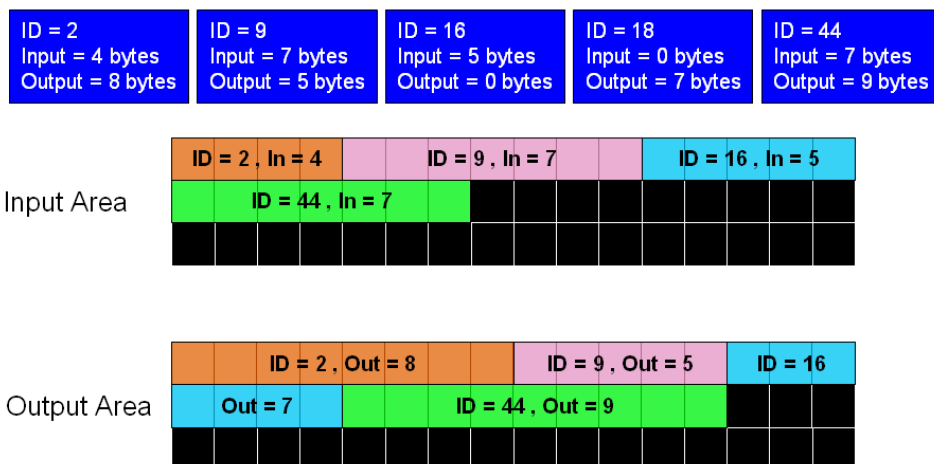

Figure 3.12 The example of the I-8124W memory mapping

Example 3 :

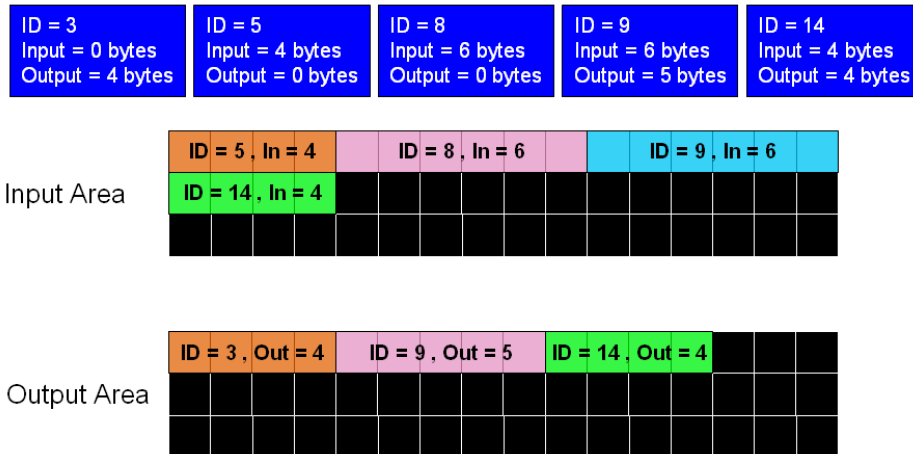

Figure 3.13 The example of the I-8124W memory mapping

User can read data from the “Remote Input Area” or write data to the “Remote Output Area”. There are three functions to access these two areas.

1.I8124_ReadInputArea

Call this function to get a bulk data from the “Remote Input Area”. Please refer to the section 4.3.40 for more information.

2.I8124_WriteOutputArea

Call this function to set a bulk data to the “Remote Output Area”. Please refer to the section 4.3.41 for more information.

3.I8124_ReadbackOutputArea

Call this function to get a bulk data from “Remote Output Area”. Please refer to the section 4.3.42 for more information.

Note:

If users add/remove any slaves’ information into/from the I-8124W, they need to reset firmware to update the modification of the data arrangement of the “Remote Input Area” and “Remote Output Area”. In other word, if users have called these functions below, they need to call I8124_ResetFirmware to make the modification active.

1. I8124_AddDevice
2. I8124_RemoveDevice
3. I8124_AddIOConnection
4. I8124_RemoveIOConnection

4. Function description

All the functions of the I-8124W can be separated into five groups. The classifications are shown Figure 4.1.

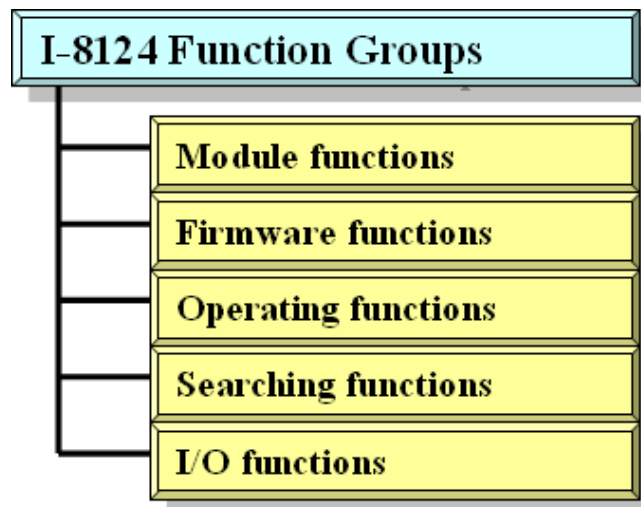

Figure 4.1 Five Function Groups

[Module Functions]

The functions in this group help users to find the I-8124W modules or get the information of the I-8124W. The users can use these functions to configure or manage the I-8124W in the WP-8000 or XPAC-8000 series MCU.

[Firmware Functions]

The functions in this group help users to operate the firmware or get the status of the firmware inside the I-8124W module.

[Operating Functions]

These functions are the important operation of the DeviceNet master. They help users to configure the whole network.

[Searching Functions]

The functions can help user to debug the network, including the wire connection, the slave device's setting, and etc. When building the DeviceNet network, users can use these functions to make sure that the network or the slave device is fine.

[I/O Functions]

These functions help user to read or write the I/O data from or to the remote slave devices.

4.1 DLL Function Definition and Description

All the functions provided in the I8124_eVC.DLL or I8124_DotNET.DLL are listed in the following table and detail information for each function is presented in the next sub-section. However, in order to make the descriptions more simply and clearly, the attributes for the both input and output parameter functions are given as **[input]** and **[output]** respectively, as shown in the following table.

Keyword	Set parameter by user before calling this function?	Get the data from this parameter after calling this function?
[input]	Yes	No
[output]	No	Yes

Table 4.1.1 Functions Table (Module Functions)

No.	Function Name	Description
1	I8124_TotalI8124Module	Get total I-8124W modules in the MCU
2	I8124_ActiveModule	Make I-8124W module active
3	I8124_CloseModule	Close all the I-8124W modules
4	I8124_GetDLLVersion	Get the DLL version of the I8124_eVC.DLL or I8124_DotNET.DLL

Table 4.1.2 Functions Table (Firmware Functions)

No.	Function Name	Description
1	I8124_GetFirmwareVersion	Get the version of the firmware inside the I-8124W module
2	I8124_ResetFirmware	Reset the firmware in the I-8124W module

Table 4.1.3 Functions Table (Operating Functions) 1/2

No.	Function Name	Description
1	I8124_SetMasterMACID	Set the MAC ID of the I-8124W module (DeviceNet Master's MAC ID)
2	I8124_GetMasterMACID	Get the MAC ID of the I-8124W module (DeviceNet Master's MAC ID)
3	I8124_GetBaudRate	Get the baud rate of the CAN bus
4	I8124_SetBaudRate	Set the baud rate of the CAN bus
5	I8124_GetMasterStatus	Get the status of the I-8124W module (DeviceNet Master's status) at present
6	I8124_GetSlaveStatus	Get the slave device's status.
7	I8124_StartDevice	I-8124W will start to communicate with the specific slave device
8	I8124_StopDevice	I-8124W will stop to communicate with the specific slave device
9	I8124_StartAllDevice	I-8124W will start to communicate with all slave devices
10	I8124_StopAllDevice	I-8124W will stop to communicate with all slave devices
11	I8124_AddDevice	Add the specific slave device's information into the I-8124W module (DeviceNet Master)
12	I8124_RemoveDevice	Remove the specific slave device's information from the I-8124W module (DeviceNet Master)
13	I8124_AddIOConnection	Add I/O information of the specific slave device into the I-8124W module (DeviceNet Master)
14	I8124_RemoveIOConnection	Remove specific slave device's I/O information from the I-8124W module (DeviceNet Master)

Table 4.1.4 Functions Table (Operating Functions) 2/2

No.	Function Name	Description
16	I8124_GetAttribute	Send the obtained attribute command to the slave device.
17	I8124_GetAttributeW	Send the obtained attribute command to the slave device.
18	I8124_IsGetAttributeOK	Check whether the slave has replied for the getting command or not.
19	I8124_GetAttributeValue	Get the attribute value of the I8124_GetAttributeW
20	I8124_SetAttribute	Send the configured attribute command to the slave device.
21	I8124_SetAttributeW	Send the configured attribute command to the slave device.
22	I8124_IsSetAttributeOK	Check whether the slave has replied for the setting command or not.
23	I8124_GetDeviceInfoFromScanList	Get specific slave device's I/O information from the Scan List within the I-8124W module.
24	I8124_GetScanList	Get the I/O information of all slave devices from the Scan List within the I-8124W module.
25	I8124_ImportEEPROM	Write the I/O information of all slave devices into the EEPROM within the I-8124W module.
26	I8124_ClearAllConfig	Clear all configurations in the EEPROM within the I-8124W module.
27	I8124_SendExplicitMSG	Send the explicit request command.
28	I8124_SendExplicitMSG_W	Send the explicit request command.
29	I8124_IsExplicitMSGRespOK	Check whether the I-8124W has received the response message or not.
30	I8124_GetExplicitMSGRespValue	Get the attribute value of the specific device's instance.

Table 4.1.5 Functions Table (Searching Functions)

No.	Function Name	Description
1	I8124_SearchAllDevices	I-8124W will search the DeviceNet network to find out the I/O information of all slave devices.
2	I8124_SearchSpecificDevice	I-8124W will search the DeviceNet network to find out the I/O information of specific slave devices.
3	I8124_IsSearchOK	Check whether the I-8124W has searched completely or not.
4	I8124_GetSearchedDevices	Get the result of the searching command and retrieve the slave's I/O information.

Table 4.1.6 Functions Table (I/O Functions)

No.	Function Name	Description
1	I8124_ReadInputData	Read the input data via I/O connection such as Poll, Strobe, COS, Cyclic.
2	I8124_WriteOutputData	Write the output data via I/O connection such as Poll, COS, Cyclic. The Strobe doesn't support this operation.
3	I8124_ReadbackOutputData	Read back the output data via I/O connection such as Poll, COS, Cyclic. The Strobe doesn't support this operation.
4	I8124_ReadInputArea	Read the bulk data from the input area memory.
5	I8124_WriteOutputArea	Write the bulk data to the output area memory.
6	I8124_ReadbackOutputArea	Read back the bulk data from the output area memory.

4.2 Function Return Code

Table 4.2.1 Interpretation of the return code (General Error) 1/2

Return Code	Error ID	Comment
0	I8124_NoError	No error
10003	I8120_SlotNumberError	The slot number is incorrect.
10007	I8120_InitError	Hardware initialize error
10021	I8120_SoftBufferIsEmpty	CAN buffer has no data
10022	I8120_SoftBufferIsFull	CAN buffer is full
10023	I8120_TimeOut	Firmware response timeout
10024	I8120_SetCyclicMsgFailure	Cyclic Message Error
10025	I8120_DpramOverRange	Dual Port RAM over range
10026	I8120_NoDpramCmd	No command within Dual Port RAM
10027	I8120_ModeError	Mode Error
10030	I8120_NoFileInside	No firmware exist
10031	I8120_DownloadFailure	Download Fail
10032	I8120_EEPROMDamage	EEPROM is out of order
10033	I8120_NotEnoughSpace	EEPROM is full
10034	I8120_StillDownloading	Downloading firmware
10035	I8120_BoardModeError	Mode Error
10036	I8120_SetDateTimeFailure	Can not update the clock.
10040	I8120_SlotNotConfig	The slot has not been configured
10041	I8120_SlotNotInit	The slot has not been initialized
10042	I8120_ReplyError	The slot replied error

Table 4.2.1 Interpretation of the return code (General Error) 2/2

Return Code	Error ID	Comment
5000	DNMXS_UnKnowError	The DeviceNet has some unknown errors.
1000	DNMXS_BoardNotActive	The I-8124W has not been activated.
1001	DNMXS_OnlineError	The master MAC ID collides with other slave device in the DeviceNet network.
1002	DNMXS_CANBusError	The CAN port can't send message. Please check the baud rate or the port of the CAN bus.
1003	DNMXS_Booting	The I-8124W is still booting.
1050	DNMXS_MACIDError	The MAC ID is exceed the range(0 ~ 63)
1051	DNMXS_BaudRateError	The baud rate is exceed the range(0 ~ 2)
1052	DNMXS_ConnectionTypeError	The connection type is exceed the range (0 ~ 4)
1053	DNMXS_DuplicMasterMACID	The MAC ID is the same with the master's ID.
1054	DNMXS_EEPROMError	The EEPROM is out of order.
1055	DNMXS_NowScanning	The I-8124W is searching the slave.
1056	DNMXS_ScanListError	The Scan List has some errors.
1057	DNMXS_DeviceExist	The information of the slave device already exists.
1058	DNMXS_DeviceNotExist	The information of the slave device doesn't exist.
1059	DNMXS_MapTableError	The MapTable has some errors.

Table 4.2.2 Interpretation of the return code (I/O Error)

Return Code	MapTable Error	Comment
1100	DNMXS_ExplicitNotAllocate	The Explicit connection is not established.
1101	DNMXS_PollNotAllocate	The Poll connection is not established.
1102	DNMXS_BitStrobeNotAllocate	The Strobe connection is not established.
1103	DNMXS_COSNotAllocate	The COS connection is not established.
1104	DNMXS_CyclicNotAllocate	The Cyclic connection is not established.
1105	DNMXS_PollAlreadyExist	The Poll connection has been established.
1106	DNMXS_BitStrobeAlreadyExist	The Poll connection has been established.
1107	DNMXS_COSAlreadyExist	The COS connection has been established.
1108	DNMXS_CyclicAlreadyExist	The Cyclic connection has been established.
1109	DNMXS_CommunicationPause	The communication among I-8124W and all slave devices has been suspended.

Table 4.2.3 Interpretation of the return code (Slave Error)

Return Code	DeviceNet Error	Comment
1150	DNMXS_SlaveNoResp	The slave has no any response.
1151	DNMXS_WaitForSlaveResp	The I-8124W is waiting for the response form the slave device.
1152	DNMXS_SlaveRespError	The slave replied some errors.
1153	DNMXS_OutputDataLenError	The output length of the I/O connection doesn't match the device's output length.
1154	DNMXS_InputDataLenError	The input length of the I/O connection doesn't match the device's input length.
1200	DNMXS_OutofRange	The specific memory address is out of range.

4.3 Function Description

4.3.1 I8124_TotalI8124Module

- **Description:**

The function can get the count of total I-8124W modules in the user's WP-8000 or XPAC-8000 series MCU.

- **Syntax:**

```
DWORD I8124_Total I8124Module (BYTE *TotalModules ,  
                                BYTE *SlotNoList)
```

- **Parameter:**

TotalModules: [output] The amount of total modules.

SlotNoList: [output] The list of all slot No. of each modules.

- **Return:**

Please refer to the chapter 4.2 for the function return code.

4.3.2 I8124_ActiveModule

4.3.2 I8124_ActiveModule

- **Description:**

The function is used to activate the entire I-8124W module. The user should wait at least two seconds before calling any other I-8124W functions. The DeviceNet master costs two seconds to check the duplicate MAC ID. It must be called once before using the other functions of I-8124W APIs.

- **Syntax:**

DWORD I8124_ActiveModule (BYTE cSlot)

- **Parameter:**

cSlot: [input] The slot number which the I-8124W is plugged in.

- **Return:**

Please refer to the chapter 4.2 for the function return code.

4.3.3 I8124_CloseModule

4.3.3 I8124_CloseModule

- **Description:**

The function is used to stop and close the I-8124W driver. This method must be called once before exiting the user's application program.

- **Syntax:**

DWORD I8124_CloseModule (BYTE cSlot)

- **Parameter:**

cSlot: [input] The slot number which the I-8124W is plugged in.

- **Return:**

Please refer to the chapter 4.2 for the function return code.

4.3.4 I8124_GetDLLVersion

- **Description:**

The function can obtain the version information of I8124_eVC.DLL or I8124_DotNET.DLL

- **Syntax:**

DWORD I8124_GetDLLVersion (void)

- **Parameter:**

None

- **Return:**

The DLL version information. For example: If 100(hex) is returned, it means DLL version is 1.00.

- **Error Return:**

Please refer to the chapter 4.2 for the function return code.

4.3.5 I8124_GetFirmwareVersion

- **Description:**

The function can obtain the version information of the firmware inside the I-8124W module.

- **Syntax:**

DWORD I8124_GetFirmwareVersion (BYTE cSlot)

- **Parameter:**

cSlot: [input] The slot number which the I-8124W is plugged in.

- **Return:**

The firmware version information. For example: If 100(hex) is returned, it means firmware version is 1.00.

- **Error Return:**

Please refer to the chapter 4.2 for the function return code.

4.3.6 I8124_ResetFirmware

4.3.6 I8124_ResetFirmware

- **Description:**

The function is used to reset the I-8124W firmware. When users have changed the baud rate of CAN bus or changed the Master's MAC ID, the function must be called to make the modification enable. After calling this function, users should wait for 2 seconds to make the firmware boot up completely.

- **Syntax:**

DWORD I8124_ResetFirmware (BYTE cSlot)

- **Parameter:**

cSlot: [input] The slot number which the I-8124W is plugged in.

- **Return:**

Please refer to the chapter 4.2 for the function return code.

4.3.7 I8124_GetMasterMACID

4.3.7 I8124_GetMasterMACID

- **Description:**

The function can get the MAC ID of the DeviceNet master (I-8124W).

- **Syntax:**

DWORD I8124_GetMasterMACID (BYTE cSlot)

- **Parameter:**

cSlot: [input] The slot number which the I-8124W is plugged in.

- **Return:**

The MAC ID information (0 ~ 64).

- **Error Return:**

Please refer to the chapter 4.2 for the function return code.

4.3.8 I8124_SetMasterMACID

4.3.8 I8124_SetMasterMACID

- **Description:**

The function can set the MAC ID of the DeviceNet master (I-8124W). After calling this function, users must call I8124_ResetFirmware to make the modification enabled. It will save the information in the EEPROM of the I-8124W.

- **Syntax:**

DWORD I8124_SetMasterMACID (BYTE cSlot, BYTE MasterMACID)

- **Parameter:**

cSlot: [input] The slot number which the I-8124W is plugged in.

MasterMACID: [input] The new MAC ID of the master. (0 ~ 63)

- **Return:**

Please refer to the chapter 4.2 for the function return code.

4.3.9 I8124_GetBaudRate

- **Description:**

This function can help you to get the DeviceNet baud rate information of the I-8124W.

- **Syntax:**

DWORD I8124_GetBaudRate (BYTE cSlot)

- **Parameter:**

cSlot: [input] The slot number which the I-8124W is plugged in.

- **Return:**

The CAN bus baud rate information in the I-8124W.

If the value is 0, the baud rate is 125Kbps.

If the value is 1, the baud rate is 250Kbps.

If the value is 2, the baud rate is 500Kbps.

- **Error Return:**

Please refer to the chapter 4.2 for the function return code.

4.3.10 I8124_SetBaudRate

- **Description:**

This function can set the DeviceNet baud rate of the I-8124W. After calling this function, you must call I8124_ResetFirmware to reset the firmware to make change enabled.

- **Syntax:**

DWORD I8124_SetBaudRate (BYTE cSlot, BYTE BaudRate)

- **Parameter:**

cSlot: [input] The slot number which the I-8124W is plugged in.

BaudRate: [input] The new baud rate value.

0 : 125K bps

1 : 250K bps

2 : 500K bps

- **Return:**

Please refer to the chapter 4.2 for the function return code.

4.3.11 I8124_GetMasterStatus

- **Description:**

The function is used to obtain the firmware status inside the I-8124W. The users can call this function to make sure that the DeviceNet master is online successfully.

- **Syntax:**

DWORD I8124_GetMasterStatus (BYTE cSlot)

- **Parameter:**

cSlot: [input] The slot number which the I-8124W is plugged in.

- **Return:**

Please refer to the chapter 4.2 for the function return code.

4.3.12 I8124_GetSlaveStatus

- **Description:**

This function gets the remote the communication status of the specific slave device.

- **Syntax:**

DWORD I8124_GetSlaveStatus (BYTE cSlot, BYTE DesMACID)

- **Parameter:**

cSlot: [input] The slot number which the I-8124W is plugged in.

DesMACID: [input] The remote slave's MAC ID. (0~63)

- **Return:**

Please refer to the chapter 4.2 for the function return code.

4.3.13 I8124_StartDevice

- **Description:**

This function is used to start to communicate with the specific device which is applied by users.

- **Syntax:**

DWORD I8124_StartDevice (BYTE cSlot, BYTE DesMACID)

- **Parameter:**

cSlot: [input] The slot number which the I-8124W is plugged in.

DesMACID: [input] The remote slave's MAC ID. (0~63)

- **Return:**

Please refer to the chapter 4.2 for the function return code.

4.3.14 I8124_StopDevice

- **Description:**

This function is used to stop to communicate with the destination device which is appointed by users.

- **Syntax:**

DWORD I8124_StopDevice (BYTE cSlot, BYTE DesMACID)

- **Parameter:**

cSlot: [input] The slot number which the I-8124W is plugged in.

DestMACID: [input] The remote slave device's MAC ID (0~63)

- **Return:**

Please refer to the chapter 4.2 for the function return code.

4.3.15 I8124_StartAllDevice

- **Description:**

This function is used to start to communicate with all slave devices in the ScanList.

- **Syntax:**

DWORD I8124_StartAllDevice (BYTE cSlot)

- **Parameter:**

cSlot: [input] The slot number which the I-8124W is plugged in.

- **Return:**

Please refer to the chapter 4.2 for the function return code.

4.3.16 I8124_StopAllDevice

- **Description:**

This function is used to stop to communicate with all destination devices in the ScanList.

- **Syntax:**

DWORD I8124_StopAllDevice (BYTE cSlot)

- **Parameter:**

cSlot: [input] The slot number which the I-8124W is plugged in.

- **Return:**

Please refer to the chapter 4.2 for the function return code.

4.3.17 I8124_AddDevice

- **Description:**

This function can add the slave devices into the ScanList of the I-8124W and save the information into the EEPROM. Before communicating with any slave device, users should call this function to add the slave device.

- **Syntax:**

DWORD I8124_AddDevice (BYTE cSlot, BYTE DesMACID,
WORD Explicit_EPR)

- **Parameter:**

cSlot: [input] The slot number which the I-8124W is plugged in.

DestMACID: [input] The remote slave device's MAC ID (0~63)

Explicit_EPR: [input] The Expected Packet Rate. (Usually is 2500).

- **Return:**

Please refer to the chapter 4.2 for the function return code.

4.3.18 I8124_RemoveDevice

4.3.18 I8124_RemoveDevice

- **Description:**

This function is used to remove the specified slave device from the ScanList in the I-8124W, and the information of the device in the EEPROM is erased at the same time.

- **Syntax:**

DWORD I8124_RemoveDevice (BYTE cSlot, BYTE DesMACID)

- **Parameter:**

cSlot: [input] The slot number which the I-8124W is plugged in.

DestMACID: [input] The remote slave device's MAC ID (0~63)

- **Return:**

Please refer to the chapter 4.2 for the function return code.

4.3.19 I8124_AddIOConnection

- **Description:**

This method is used to configure the I/O connection of the device which has specific MAC ID. The I-8124W can get/set the data via the connection, which is applied to the specific slave, according to the produced / consumed connection path of this slave device. This configuration data will be saved into EEPROM of the I-8124W.

- **Syntax:**

DWORD I8124_AddIOConnection (BYTE cSlot, BYTE DesMACID,
BYTE ConType,
WORD DeviceInputLen,
WORD DeviceOutputLen,
WORD EPR)

- **Parameter:**

cSlot: [input] The slot number which the I-8124W is plugged in.

DestMACID: [input] The remote slave device's MAC ID (0~63)

ConType: [input] The remote slave device's I/O connection type

0 : Explicit connection type

1 : Poll connection type

2 : Bit-Strobe connection type

3 : COS connection type

4 : Cyclic connection type

DeviceInputLen: [input] The remote slave device's input length. (Byte)

DeviceOutputLen: [input] The remote slave device's output length. (Byte)

EPR: [input] The expected packet rate. (mSec)

- **Return:**

Please refer to the chapter 4.2 for the function return code.

4.3.20 I8124_RemoveIOConnection

4.3.20 I8124_RemoveIOConnection

- **Description:**

The function is used to remove the I/O connection configuration.

- **Syntax:**

DWORD I8124_RemoveIOConnection (BYTE cSlot, BYTE DesMACID,
BYTE ConType)

- **Parameter:**

cSlot: [input] The slot number which the I-8124W is plugged in.

DestMACID: [input] The remote slave device's MAC ID (0~63)

ConType: [input] The remote slave device's I/O connection type

0 : Explicit connection type

1 : Poll connection type

2 : Bit-Strobe connection type

3 : COS connection type

4 : Cyclic connection type

- **Return:**

Please refer to the chapter 4.2 for the function return code.

4.3.21 I8124_GetAttribute

4.3.21 I8124_GetAttribute

- **Description:**

This function is used to send the request command to retrieve the attribute value of the specific device's instance. Before calling this function, you must start the device. After calling this function, you should execute the "I8124_GetAttributeValue" to get the response message returned from the remote slave device.

This old function will be removed in the future. Please use the new function which is "I8124_GetAttributeW".

- **Syntax:**

DWORD I8124_GetAttribute (BYTE cSlot, BYTE DesMACID,
BYTE ClassID, BYTE InstanceID,
BYTE AttributeID)

- **Parameter:**

cSlot: [input] The slot number which the I-8124W is plugged in.

DestMACID: [input] The remote slave device's MAC ID (0~63)

ClassID: [input] The remote slave device's ClassID(BYTE)

InstanceID: [input] The remote slave device's InstanceID(BYTE)

AttributeID: [input] The remote slave device's AttributeID

- **Return:**

Please refer to the chapter 4.2 for the function return code.

4.3.22 I8124_GetAttributeW

- **Description:**

This function is used to send the request command to retrieve the attribute value of the specific device's instance. Before calling this function, you must start the device. After calling this function, you should execute the "I8124_GetAttributeValue" to get the response message returned from the remote slave device.

This function could totally complain with the old function which has the same name without the "W". The user could use this function instead of the "I8124_GetAttribute".

- **Syntax:**

DWORD I8124_GetAttributeW (BYTE cSlot, BYTE DesMACID,
WORD ClassID, WORD InstanceID,
BYTE AttributeID)

- **Parameter:**

cSlot: [input] The slot number which the I-8124W is plugged in.

DestMACID: [input] The remote slave device's MAC ID (0~63)

ClassID: [input] The remote slave device's ClassID(WORD)

InstanceID: [input] The remote slave device's InstanceID(WORD)

AttributeID: [input] The remote slave device's AttributeID

- **Return:**

Please refer to the chapter 4.2 for the function return code.

4.3.23 I8124_IsGetAttributeOK

- **Description:**

This function is used to check whether the I-8124W has received the response message or not. After checking the response message, you should execute the “I8124_GetAttributeValue” to get the response message returned from the remote slave device.

- **Syntax:**

DWORD I8124_IsGetAttributeOK (BYTE cSlot, BYTE DesMACID)

- **Parameter:**

cSlot: [input] The slot number which the I-8124W is plugged in.

DestMACID: [input] The remote slave device’s MAC ID (0~63)

- **Return:**

Please refer to the chapter 4.2 for the function return code.

4.3.24 I8124_GetAttributeValue

4.3.24 I8124_GetAttributeValue

- **Description:**

This function is used to get the attribute value of the specific device's instance from the remote slave device. Before calling this function, users should call I8124_GetAttributeW to send request command first.

- **Syntax:**

```
DWORD I8124_GetAttributeValue (BYTE cSlot, BYTE DesMACID,  
                               WORD *DataLen, BYTE *DATA)
```

- **Parameter:**

cSlot: [input] The slot number which the I-8124W is plugged in.

DestMACID: [input] The remote slave device's MAC ID (0~63)

DataLen: [output] The length of the attribute value (in byte).

DATA: [output] The attribute value that returned from the slave device.

- **Return:**

Please refer to the chapter 4.2 for the function return code.

4.3.25 I8124_SetAttribute

4.3.25 I8124_SetAttribute

- **Description:**

The method is used to set the attribute of the specific device's instance. Before calling this function, you must start the device. After calling this function, you should execute the "I8124_IsSetAttributeOK" to check the response message returned from the remote slave device.

This old function will be removed in the future. Please use the new function which is "I8124_SetAttributeW".

- **Syntax:**

DWORD I8124_SetAttribute (BYTE cSlot, BYTE DesMACID,
BYTE ClassID, BYTE InstanceID,
BYTE AttributeID, WORD DataLen,
BYTE *DATA)

- **Parameter:**

cSlot: [input] The slot number which the I-8124W is plugged in.

DestMACID: [input] The remote slave device's MAC ID (0~63)

ClassID: [input] The remote slave device's ClassID(BYTE)

InstanceID: [input] The remote slave device's InstanceID(BYTE)

AttributeID: [input] The remote slave device's AttributeID

DataLen: [input] The length of the attribute value (in byte).

DATA: [input] The attribute value that the users want to send.

- **Return:**

Please refer to the chapter 4.2 for the function return code.

4.3.26 I8124_SetAttributeW

- **Description:**

The method is used to set the attribute of the specific device's instance. Before calling this function, you must start the device. After calling this function, you should execute the "I8124_IsSetAttributeOK" to check the response message returned from the remote slave device.

This function could totally complain with the old function which has the same name without the "W". The user could use this function instead of the "I8124_SetAttribute".

- **Syntax:**

```
DWORD I8124_SetAttributeW (BYTE cSlot, BYTE DesMACID,  
                          WORD ClassID, WORD InstanceID,  
                          BYTE AttributeID, WORD DataLen,  
                          BYTE *DATA)
```

- **Parameter:**

cSlot: [input] The slot number which the I-8124W is plugged in.

DestMACID: [input] The remote slave device's MAC ID (0~63)

ClassID: [input] The remote slave device's ClassID(**WORD**)

InstanceID: [input] The remote slave device's InstanceID(**WORD**)

AttributeID: [input] The remote slave device's AttributeID

DataLen: [input] The length of the attribute value (in byte).

DATA: [input] The attribute value that the users want to send.

- **Return:**

Please refer to the chapter 4.2 for the function return code.

4.3.27 I8124_IsSetAttributeOK

4.3.27 I8124_IsSetAttributeOK

- **Description:**

This function is used to get the response value after executing the “I8124_SetAttributeW” function.

- **Syntax:**

DWORD I8124_IsSetAttributeOK (BYTE cSlot, BYTE DesMACID)

- **Parameter:**

cSlot: [input] The slot number which the I-8124W is plugged in.

DestMACID: [input] The remote slave device’s MAC ID (0~63)

- **Return:**

Please refer to the chapter 4.2 for the function return code.

4.3.28 I8124_ClearAllConfig

4.3.28 I8124_ClearAllConfig

- **Description:**

This function will clear all configurations in the EEPROM of the I-8124W.

- **Syntax:**

DWORD I8124_ClearAllConfig (BYTE cSlot)

- **Parameter:**

cSlot: [input] The slot number which the I-8124W is plugged in.

- **Return:**

Please refer to the chapter 4.2 for the function return code.

4.3.29 I8124_SearchAllDevices

4.3.29 I8124_SearchAllDevices

- **Description:**

This function is used to retrieve all devices in DeviceNet network. This function makes the I-8124W to start the searching process. The users need to check whether the process is complete or not by calling the “I8124_IsSearchOK”. After completing the search process, the users could call the “I8124_GetSearchedDevices” to get the searched devices. Attention that this function will terminate all communications with remote devices. This function is usually used to develop or debug applications.

- **Syntax:**

DWORD I8124_SearchAllDevices (BYTE cSlot)

- **Parameter:**

cSlot: [input] The slot number which the I-8124W is plugged in.

- **Return:**

Please refer to the chapter 4.2 for the function return code.

4.3.30 I8124_SearchSpecificDevice

4.3.30 I8124_SearchSpecificDevice

- **Description:**

This function is used to retrieve some devices which specified by the users. This function makes the I-8124W to start the searching process. The users need to check whether the process is complete or not by calling the “I8124_IsSearchOK”. After completing the search process, the users could call the “I8124_GetSearchedDevices“ to get the searched devices. Attention! This function will terminate all communications with remote devices. This function is usually used to develop or debug the applications.

- **Syntax:**

DWORD I8124_SearchSpecificDevice (BYTE cSlot,WORD ListCount,
BYTE *DesMACIDList)

- **Parameter:**

cSlot: [input] The slot number which the I-8124W is plugged in.

ListCount: [input] The amount of the slave’s ID.

DestMACIDList: [input] The list of all slave’s MAC ID.

- **Return:**

Please refer to the chapter 4.2 for the function return code.

4.3.31 I8124_IsSearchOK

4.3.31 I8124_IsSearchOK

- **Description:**

This function will check whether the searching process has finished or not.

- **Syntax:**

DWORD I8124_IsSearchOK (BYTE cSlot)

- **Parameter:**

cSlot: [input] The slot number which the I-8124W is plugged in.

- **Return:**

Please refer to the chapter 4.2 for the function return code.

4.3.32 I8124_GetSearchedDevices

4.3.32 I8124_GetSearchedDevices

- **Description:**

This function will get the information of the device which has been searched in the network.

- **Syntax:**

```
DWORD I8124_GetSearchedDevices (BYTE cSlot,  
                                WORD *TotalDevices,  
                                BYTE *DesMACID,  
                                BYTE *Type,  
                                WORD *DeviceInputLen,  
                                WORD *DeviceOutputLen)
```

- **Parameter:**

cSlot: [input] The slot number which the I-8124W is plugged in the PAC.

TotalDevices: [output] The amount of all slave device which were found.

DesMACID: [output] The list of slave's MAC ID which were found.

Type: [output] The list of slave's connection type which were found.

0 : Explicit connection type

1 : Poll connection type

2 : Bit-Strobe connection type

3 : COS connection type

4 : Cyclic connection type

DeviceInputLen: [output] The list of slave's input length which were found.

DeviceOutputLen: [output] The list of slave's output length which were found.

- **Return:**

Please refer to the chapter 4.2 for the function return code.

4.3.33 I8124_GetDeviceInfoFromScanList

4.3.33 I8124_GetDeviceInfoFromScanList

- **Description:**

This function will obtain the ScanList data of the specific device in the I-8124W.

- **Syntax:**

```
DWORD I8124_GetDeviceInfoFromScanList  
    (BYTE cSlot, BYTE DesMACID, WORD *ListCount,  
     BYTE *ConnectionTypeList, WORD *InputDataLenList,  
     WORD *OutputDataLenList,WORD *EPRList)
```

- **Parameter:**

cSlot: [input] The slot number which the I-8124W is plugged in.

DesMACID: [input] The MAC ID number which the users want to get the information.

ListCount: [output] The amount of all information items.

ConnectionTypeList: [output] The list of slave's connection type.

0 : Explicit connection type

1 : Poll connection type

2 : Bit-Strobe connection type

3 : COS connection type

4 : Cyclic connection type

InputDataLenList: [output] The list of slave's input length.

OutputDataLenList: [output] The list of slave's output length.

EPRList: [output] The list of slave's expected packet rate.

- **Return:**

Please refer to the chapter 4.2 for the function return code.

4.3.34 I8124_GetScanList

4.3.34 I8124_GetScanList

- **Description:**

This function will get all the ScanList data in the I-8124W.

- **Syntax:**

```
DWORD I8124_GetScanList (BYTE cSlot, WORD *TotalDevices,  
                        BYTE *DesMACIDList,  
                        BYTE *ConnectionTypeList,  
                        WORD *InputDataLenList,  
                        WORD *OutputDataLenList,  
                        WORD *EPR_List)
```

- **Parameter:**

cSlot: [input] The slot number which the I-8124W is plugged in.

TotalDevices: [output] The data count of all the information.

DestMACIDList: [output] The MAC ID of all the slave devices in the ScanList.

ConnectionTypeList: [output] The connection type of all the slave devices in the ScanList.

0 : Explicit connection type

1 : Poll connection type

2 : Bit-Strobe connection type

3 : COS connection type

4 : Cyclic connection type

InputDataLenList: [output] The input data length of all the slave devices in the ScanList.

OutputDataLenList: [output] The output data length of all the slave devices in the ScanList.

EPR_List: [output] The EPR value of all the slave devices in the ScanList.

- **Return:**

Please refer to the chapter 4.2 for the function return code.

4.3.35 I8124_ImportEEPROM

4.3.35 I8124_ImportEEPROM

- **Description:**

This function provides a convenient method which could write a great amount of devices' information into the EEPROM.

- **Syntax:**

```
DWORD I8124_ImportEEPROM (BYTE cSlot,WORD ListCount,  
                           BYTE *DesMACIDList,  
                           BYTE *ConnectionTypeList,  
                           WORD *InputDataLenList,  
                           WORD *OutputDataLenList,  
                           WORD *EPR_List)
```

- **Parameter:**

cSlot: [input] The slot number which the I-8124W is plugged in.

ListCount: [input] The data count of all the information.

DestMACIDList: [input] The MAC ID of all the slave devices.

ConnectionTypeList: [input] The connection type of all slave devices.

0 : Explicit connection type

1 : Poll connection type

2 : Bit-Strobe connection type

3 : COS connection type

4 : Cyclic connection type

InputDataLenList: [input] The input data length of all slave devices.

OutputDataLenList: [input] The output data length of all slave devices.

EPR_List: [input] The EPR value of all slave devices.

- **Return:**

Please refer to the chapter 4.2 for the function return code.

4.3.36 I8124_ReadInputData

4.3.36 I8124_ReadInputData

- **Description:**

This function is used to get the data according with the produced connection path of the specific MAC ID device via the I/O connection.

- **Syntax:**

DWORD I8124_ReadInputData (BYTE cSlot, BYTE DesMACID,
BYTE ConType, WORD *IOLen,
BYTE *IODATA)

- **Parameter:**

cSlot: [input] The slot number which the I-8124W is plugged in.

DestMACID: [input] The remote slave device's MAC ID (0~63)

ConType: [input] The connection type of the remote slave.

0 : Explicit connection type

1 : Poll connection type

2 : Bit-Strobe connection type

3 : COS connection type

4 : Cyclic connection type

IOLen: [output] The length of the I/O data (In byte).

IODATA: [output] The remote I/O data.

- **Return:**

Please refer to the chapter 4.2 for the function return code.

4.3.37 I8124_WriteOutputData

4.3.37 I8124_WriteOutputData

- **Description:**

The function will set the data according with the consumed connection path of the specific MAC ID device via the I/O connection.

- **Syntax:**

DWORD I8124_WriteOutputData (BYTE cSlot, BYTE DesMACID,
BYTE ConType, WORD IOLen,
BYTE *IODATA)

- **Parameter:**

cSlot: [input] The slot number which the I-8124W is plugged in.

DestMACID: [input] The remote slave device's MAC ID (0~63)

ConType: [input] The connection type of the remote slave.

0 : Explicit connection type

1 : Poll connection type

2 : Bit-Strobe connection type

3 : COS connection type

4 : Cyclic connection type

IOLen: [Input] The length of the I/O data (In byte).

IODATA: [Input] The remote I/O data.

- **Return:**

Please refer to the chapter 4.2 for the function return code.

4.3.38 I8124_SendExplicitMSG

- **Description:**

This function is used to send the explicit request command to retrieve or configure the attribute value of the specific device's instance. Before calling this function, you must start the device. After calling this function, you should execute the "I8124_GetExplicitMSGRespValue" to get the response message returned from the remote slave device.

This old function will be removed in the future. Please use the new function which is "I8124_SendExplicitMSG_W".

- **Syntax:**

DWORD I8124_SendExplicitMSG (BYTE cSlot, BYTE DesMACID,
BYTE ServiceID, BYTE ClassID,
BYTE InstanceID, WORD DataLen,
BYTE *DATA)

- **Parameter:**

cSlot: [input] The slot number which the I-8124W is plugged in.

DestMACID: [input] The remote slave device's MAC ID (0~63)

ServiceID: [input] The remote slave device's ServiceID.

ClassID: [input] The remote slave device's ClassID(BYTE).

InstanceID: [input] The remote slave device's InstanceID(BYTE).

DataLen: [input] The length of the attribute value (in byte).

DATA: [input] The attribute value that the users want to send.

- **Return:**

Please refer to the chapter 4.2 for the function return code.

4.3.39 I8124_SendExplicitMSG_W

- **Description:**

This function is used to send the explicit request command to retrieve or configure the attribute value of the specific device's instance. Before calling this function, you must start the device. After calling this function, you should execute the "I8124_GetExplicitMSGRespValue" to get the response message returned from the remote slave device.

This function could totally complain with the old function which has the same name without the "_W". The user could use this function instead of the "I8124_SendExplicitMSG".

- **Syntax:**

DWORD I8124_SendExplicitMSG_W (BYTE cSlot, BYTE DesMACID, BYTE ServiceID, WORD ClassID, WORD InstanceID, WORD DataLen, BYTE *DATA)

- **Parameter:**

cSlot: [input] The slot number which the I-8124W is plugged in.

DestMACID: [input] The remote slave device's MAC ID (0~63)

ServiceID: [input] The remote slave device's ServiceID.

ClassID: [input] The remote slave device's ClassID(WORD).

InstanceID: [input] The remote slave device's InstanceID(WORD).

DataLen: [input] The length of the attribute value (in byte).

DATA: [input] The attribute value that the users want to send.

- **Return:**

Please refer to the chapter 4.2 for the function return code.

4.3.40 I8124_IsExplicitMSGRespOK

- **Description:**

This function is used to check whether the I-8124W has received the response message or not. After checking the response message, you should execute the “I8124_GetExplicitMSGRespValue” to get the response message returned from the remote slave device.

- **Syntax:**

DWORD I8124_IsExplicitMSGRespOK (BYTE cSlot, BYTE DesMACID)

- **Parameter:**

cSlot: [input] The slot number which the I-8124W is plugged in.

DestMACID: [input] The remote slave device’s MAC ID (0~63)

- **Return:**

Please refer to the chapter 4.2 for the function return code.

4.3.41 I8124_GetExplicitMSGRespValue

- **Description:**

This function is used to get the attribute value of the specific device's instance from the remote slave device. Before calling this function, users should call I8124_SendExplicitMSG_W to send request command first.

- **Syntax:**

```
DWORD I8124_GetExplicitMSGRespValue (BYTE cSlot,  
                                     BYTE DesMACID,  
                                     WORD *DataLen ,  
                                     BYTE *DATA)
```

- **Parameter:**

cSlot: [input] The slot number which the I-8124W is plugged in.

DestMACID: [input] The remote slave device's MAC ID (0~63)

DataLen: [output] The length of the attribute value (in byte).

DATA: [output] The attribute value that returned from the slave device.

- **Return:**

Please refer to the chapter 4.2 for the function return code.

4.3.42 I8124_ReadbackOutputData

- **Description:**

The function will read the data according with the consumed connection path of the specific MAC ID device via the I/O connection.

- **Syntax:**

```
DWORD I8124_ReadbackOutputData (BYTE cSlot,  
                                BYTE DesMACID,  
                                BYTE ConType,  
                                WORD *IOLen,  
                                BYTE *IODATA)
```

- **Parameter:**

cSlot: [input] The slot number which the I-8124W is plugged in.

DestMACID: [input] The remote slave device's MAC ID (0~63)

ConType: [input] The connection type of the remote slave.

0 : Explicit connection type

1 : Poll connection type

2 : Bit-Strobe connection type

3 : COS connection type

4 : Cyclic connection type

IOLen: [output] The length of the I/O data (In byte).

IODATA: [output] The remote I/O data.

- **Return:**

Please refer to the chapter 4.2 for the function return code.

4.3.43 I8124_ReadInputArea (Advanced Option)

- **Description:**

This function reads the bulk data from the input area memory. Users can use this function to read all the input data quickly. It provides an effective method to read the bulk data in one command. If the users need to read the input data of all slave devices, they need to call the "I8124_ReadInputData" for each slave device in general. By calling the advanced function "I8124_ReadInputArea", the whole input data would be read once in this function call. Please refer to the section 3.7 for more description.

- **Syntax:**

```
DWORD I8124_ReadInputArea (BYTE cSlot,  
                           WORD Offset,  
                           WORD DataLen,  
                           BYTE *DataArray)
```

- **Parameter:**

cSlot: [input] The slot number which the I-8124W is plugged in.

Offset: [input] The offset of the input area memory.

DataLen: [input] The length in byte which the users want to read.

DataArray: [output] The data pointer of the obtained data from the input area memory.

- **Return:**

Please refer to the section 4.2 for the return code.

- **Example:**

Example 1 :

ID = 2 Input = 4 bytes Output = 5 bytes	ID = 3 Input = 4 bytes Output = 4 bytes	ID = 5 Input = 4 bytes Output = 5 bytes	ID = 8 Input = 6 bytes Output = 8 bytes	ID = 9 Input = 6 bytes Output = 7 bytes
---	---	---	---	---

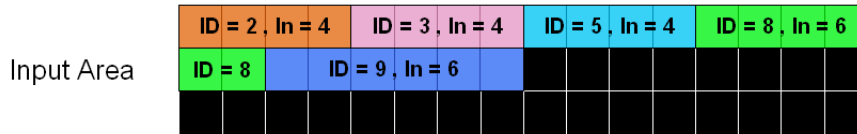

```

BYTE cSlot = 0; //Assume that the I-8124 was plugged in the slot 0.
WORD Offset = 0;
WORD DataLen = 0;
BYTE dataArray[512] = {0};

```

```

//Read whole input data of all slave devices.
Offset = 0; //Read the data from the beginning of the input area.
DataLen = 4 + 4 + 4 + 6 + 6; //The sum of all slave's input length.
I8124_ReadInputArea (cSlot, Offset, DataLen, dataArray);
dataArray = [The whole input data of all slave devices];

```

```

//Read input data of the slave device which ID = 5.
Offset = 4 + 4; //Read the data from the beginning of the ID = 5.
DataLen = 4; //The input length of the ID = 5.
I8124_ReadInputArea (cSlot, Offset, DataLen, dataArray);
dataArray = [The input data of the slave device which ID = 5];

```

4.3.44 I8124_WriteOutputArea (Advanced Option)

- **Description:**

This function can write the bulk data to the output area memory. The DeviceNet slave will change the output status of the DeviceNet slaves according to the data located in the output area memory. Users can use this function to write a large amount of the output data. It provides effective method to change bulk data in one command. If the users need to write the output data of all slave devices, they need to call the "I8124_WriteOutputData" for each slave device in general. By calling the advanced function "I8124_WriteOutputArea", the whole output data would be wrote once in this function call. Please refer to the section 3.7 for more description.

- **Syntax:**

```
DWORD I8124_WriteOutputArea (BYTE cSlot,  
                             WORD Offset,  
                             WORD DataLen,  
                             BYTE *dataArray)
```

- **Parameter:**

cSlot: [input] The slot number which the I-8124W is plugged in.

Offset: [input] The offset of the input area memory.

DataLen: [input] The length in byte which the users want to write.

DataArray: [input] The data pointer pointed the data written to the output data area.

- **Return:**

Please refer to the section 4.2 for the return code.

- **Example:**

Example 1 :

ID = 2 Input = 4 bytes Output = 5 bytes	ID = 3 Input = 4 bytes Output = 4 bytes	ID = 5 Input = 4 bytes Output = 5 bytes	ID = 8 Input = 6 bytes Output = 8 bytes	ID = 9 Input = 6 bytes Output = 7 bytes
---	---	---	---	---

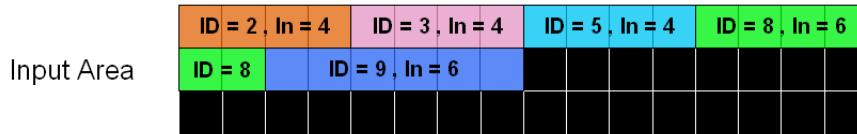

```

BYTE cSlot = 0; //Assume that the I-8124 was plugged in the slot 0.
WORD Offset = 0;
WORD DataLen = 0;
BYTE DataArray[512] = {0};

```

```

//Write the whole output data of all slave devices.
Offset = 0; //Write the data from the beginning of the output area.
DataLen = 5 + 4 + 5 + 8 + 7; //The sum of all slave's output length.
DataArray = [The whole output data];
I8124_WriteOutputArea (cSlot, Offset, DataLen, DataArray);

```

```

//Write the output data of the slave device which ID = 5.
Offset = 5 + 4; //Write the data from the beginning of the ID = 5.
DataLen = 5; //The output length of the ID = 5.
DataArray = [The output data of the ID = 5];
I8124_WriteOutputArea (cSlot, Offset, DataLen, DataArray);

```

4.3.45 I8124_ReadbackOutputArea (Advanced Option)

- **Description:**

This function reads the bulk data from the output area memory. It does not change the output data located in the output area memory. Users can use this function to read back a large amount of the output data, but the data may be different with the real output statuses of the DeviceNet slaves. It provides effective method to read bulk data in one command. If the users need to read back the output data of all slave devices, they need to call the “I8124_ReadbackOutputData” for each slave device in general. By calling the advanced function “I8124_ReadbackOutputArea”, the whole output data would be wrote once in this function call. Please refer to the section 3.7 for more description.

- **Syntax:**

```
DWORD I8124_ReadbackOutputArea (BYTE cSlot,  
                                WORD Offset,  
                                WORD DataLen,  
                                BYTE *DataArray)
```

- **Parameter:**

cSlot: [input] The slot number which the I-8124W is plugged in.

Offset: [input] The offset of the output area memory.

DataLen: [input] The length in byte which the users want to read.

DataArray: [output] The data pointer pointed the observed data form the output area memory.

- **Return:**

Please refer to the section 4.2 for the return code.

- **Example:**

Example 1 :

ID = 2 Input = 4 bytes Output = 5 bytes	ID = 3 Input = 4 bytes Output = 4 bytes	ID = 5 Input = 4 bytes Output = 5 bytes	ID = 8 Input = 6 bytes Output = 8 bytes	ID = 9 Input = 6 bytes Output = 7 bytes
---	---	---	---	---

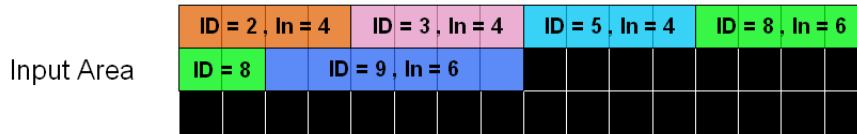

```

BYTE cSlot = 0; //Assume that the I-8124 was plugged in the slot 0.
WORD Offset = 0;
WORD DataLen = 0;
BYTE dataArray[512] = {0};

```

```

//Read back the whole output data of all slave devices.
Offset = 0; //Read back the data from the beginning of the output area.
DataLen = 5 + 4 + 5 + 8 + 7; //The sum of all slave's output length.
I8124_ReadbackOutputArea (cSlot, Offset, DataLen, dataArray);
dataArray = [The whole output data];

```

```

//Read back the output data of the slave device which ID = 5.
Offset = 5 + 4; //Read back the data from the beginning of the ID = 5.
DataLen = 5; //The output length of the ID = 5.
I8124_WriteOutputArea (cSlot, Offset, DataLen, dataArray);
dataArray = [The output data of the ID = 5];

```

4.3.46 I8124_DisableKeepAliveMsg (Advanced Option)

- **Description:**

The I-8124W will read periodically certain explicit attribute to keep the explicit connection alive. This function can disable the read process. For some slave devices, the keep explicit connection is not necessary. The users can call this function after the I8124_ActiveModule(). This disable will NOT keep in I-8124W. The users need to call this for every boot-up.

- **Syntax:**

DWORD I8124_DisableKeepAliveMsg (BYTE cSlot,
BYTE DesMACID)

- **Parameter:**

cSlot: [input] The slot number which the I-8124W is plugged in.

DestMACID: [input] The remote slave device's MAC ID (0~63)

- **Return:**

Please refer to the section 4.2 for the return code.

5. DNM_UtilityCE for WP-8000

The utility does not work normally if the DeviceNet master series hardware driver is not installed correctly.

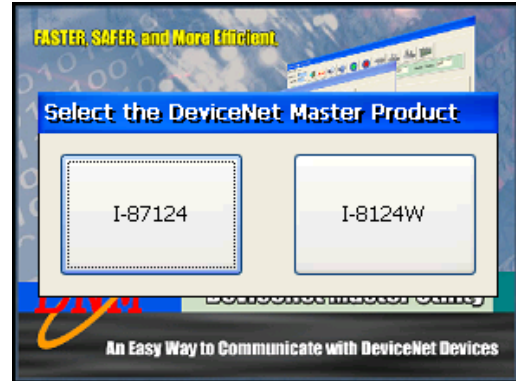

After selecting the I-8124W modules, the screen shoot is shown below.

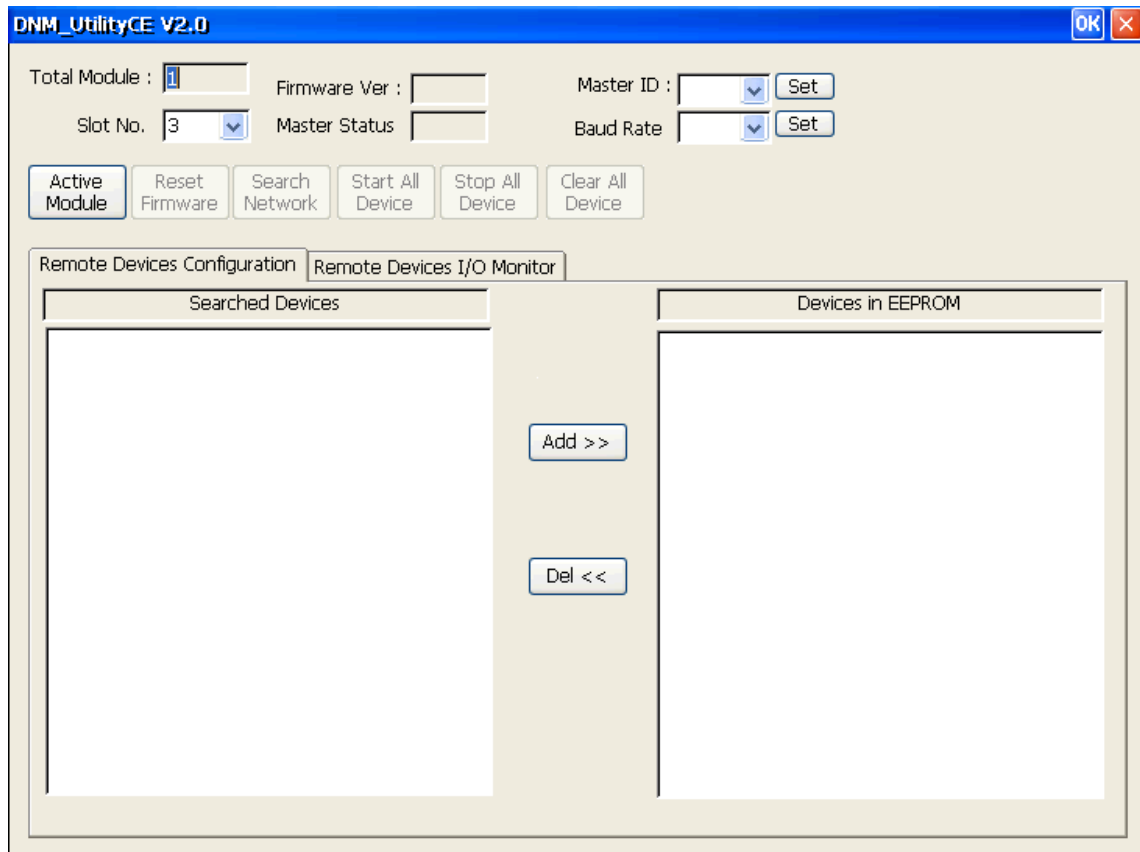

5.1 Introduction

The software utility includes various useful functions. These functions help users to diagnose and access the DeviceNet devices. There are three main parts of these functions.

- Diagnosis

This utility supports searching all devices and the specific devices in the network. These functions help users to configure the connection of the slave devices. Moreover, the software also can diagnose the remote slave devices when building the DeviceNet network.

- Configuration

This software could configure the I/O connection of the devices. After configuring the I/O connection, the information would be saved into the EEPROM of the I-8124W.

- Remote I/O access

The software utility can easily access the I/O data of all slave devices. Users can monitor the input data of the specific slave device and change the output data to the remote slave device with this utility.

5.2 Tutorial Demos

5.2.1 Where to find the Hardware Information

1. The utility would search how many modules in WP-8000 automatically. It shows the count of the modules which have been found.
2. The utility also lists the slot numbers of all modules in the “Slot No” field.

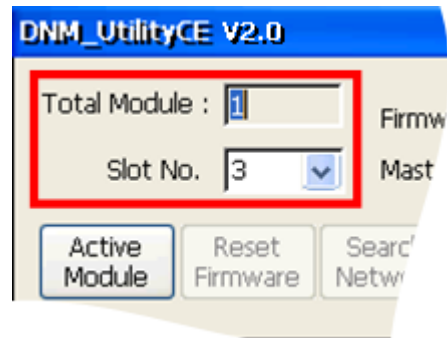

5.2.2 How to start using the utility

1. Before using this utility, users should click “ActiveModule” button to activate the DeviceNet master device hardware. That would initialize the DeviceNet master device which you have selected in the “Slot No” field.

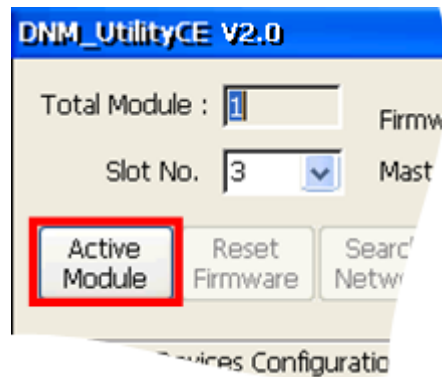

2. After activating the specific I-8124W, the utility will read all configurations from the EEPROM of the I-8124W. After reading the configuration from EEPROM of the DeviceNet master device successfully, the utility shows the information in the “Devices in EEPROM” field.

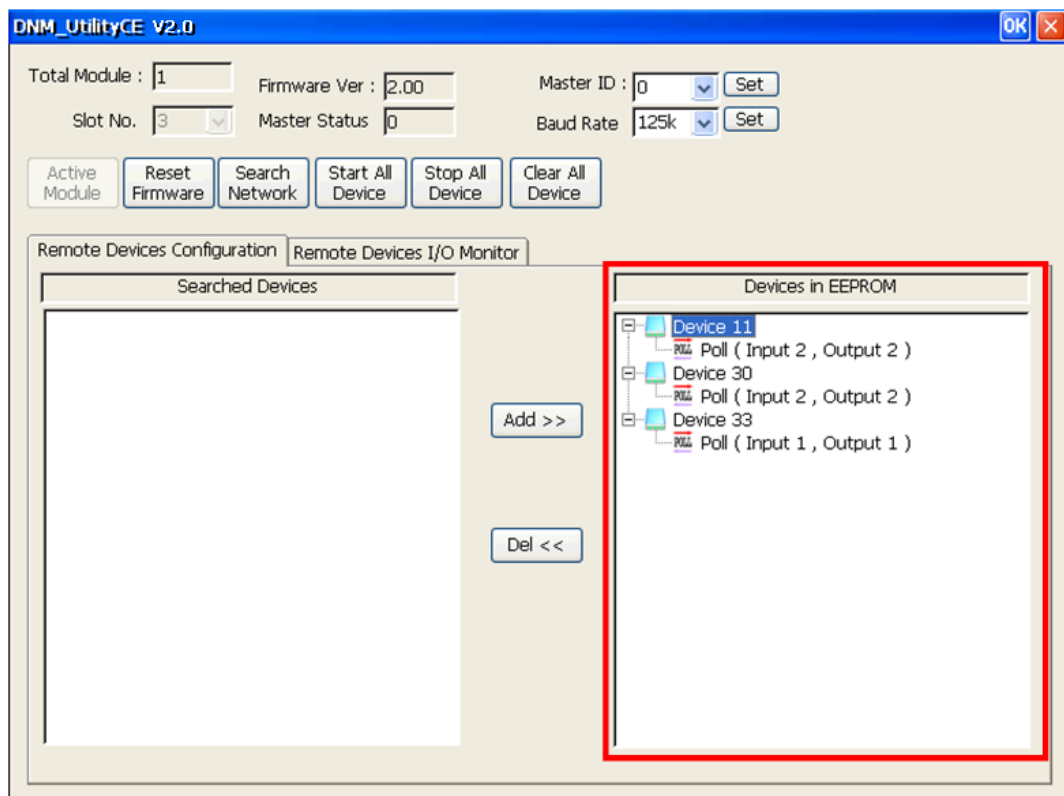

5.2.3 How to search the slave devices

1. After the module has been activated, users can press the “Search all Devices” button shown below. As users press the button, the DeviceNet master device would search the devices. It takes about 30 seconds to search the whole slave devices in the network. The numbers of scanned device is 64.

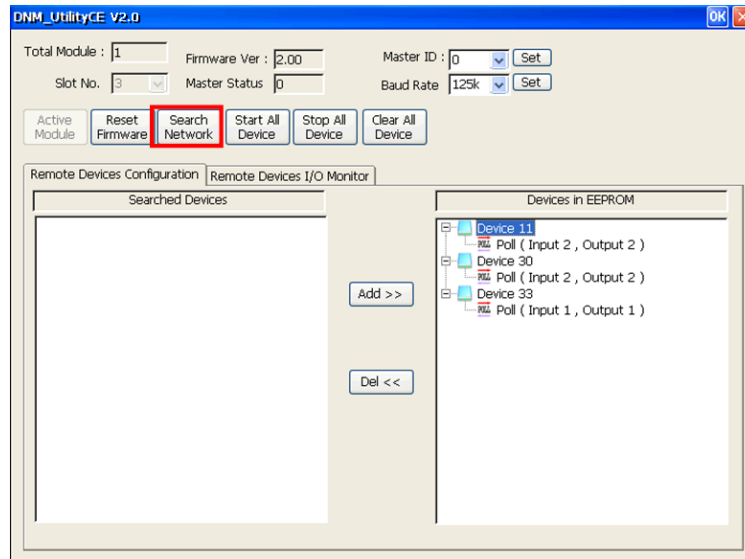

2. After finishing the searching procedure, the utility shows the information of all slave devices in the “Searched Devices” field.

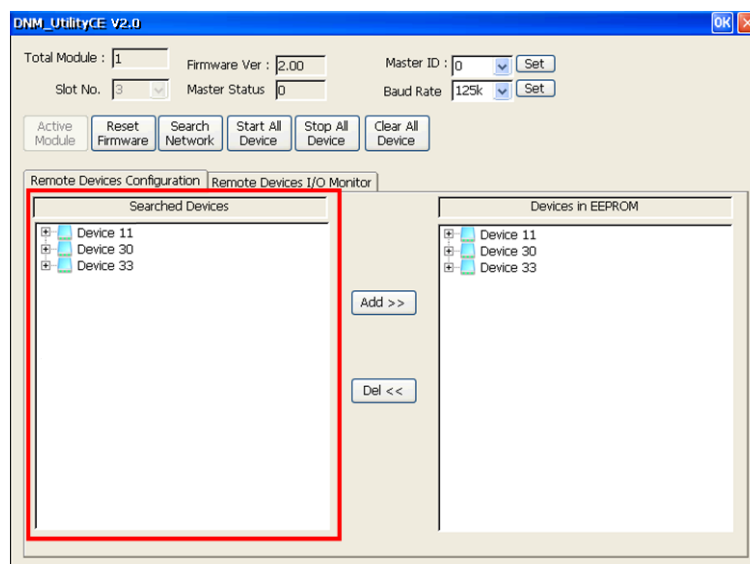

3. Users can expand the device to find out more I/O connection information of those devices.

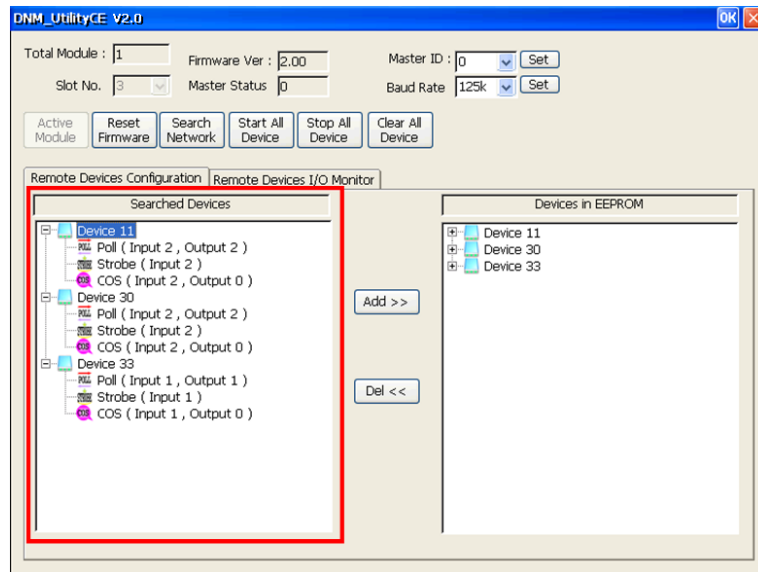

5.2.4 How to add I/O information into the EEPROM

1. Please activate your module. Refer to section 5.2.2 for more information.
2. Please search all devices. Refer to section 5.2.3 for more information.
3. Please select one of the I/O connection items in the “Searched Devices” field, and click the “Add>>” button to add the item into the “EEPROM” field.

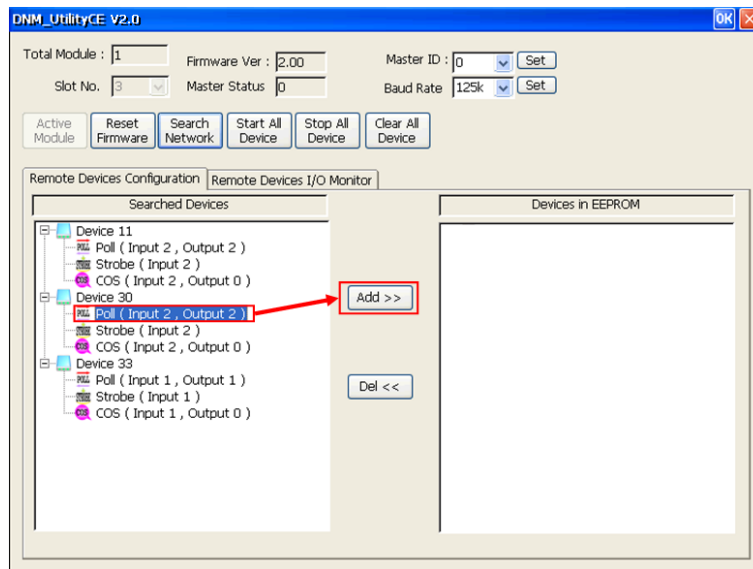

4. If the procedure is successful, users would see the successful message below. You can find the selected item which has been added into the “EEPROM” field.

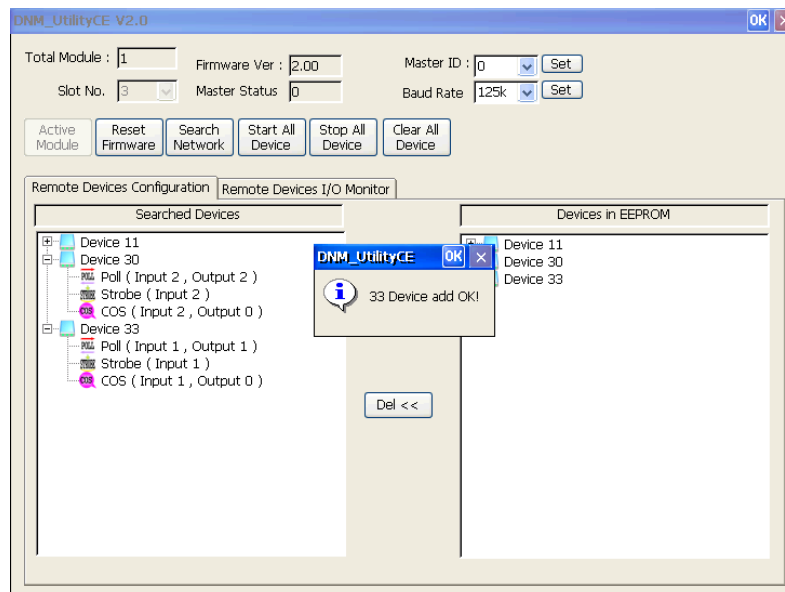

5.2.5 How to remove I/O information from the EEPROM

1. Please activate your module. Refer to section 5.2.2 for more information.
2. Please select one of the device items in the “EEPROM” field, and then click the “Del<<” button.

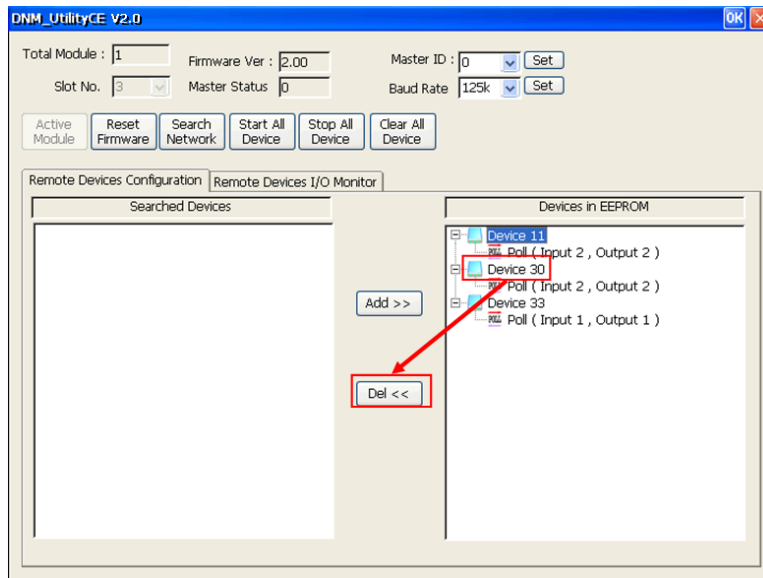

5.2.6 How to read/write the I/O data form/to the slave device

1. If users have no I/O configuration in the EEPROM, please refer to section 5.2.4 to add at least one I/O configuration.
2. Please press “Start all Device” button to communicate with all slave devices. The warning message would pop-up. In this example, please click “Yes”.

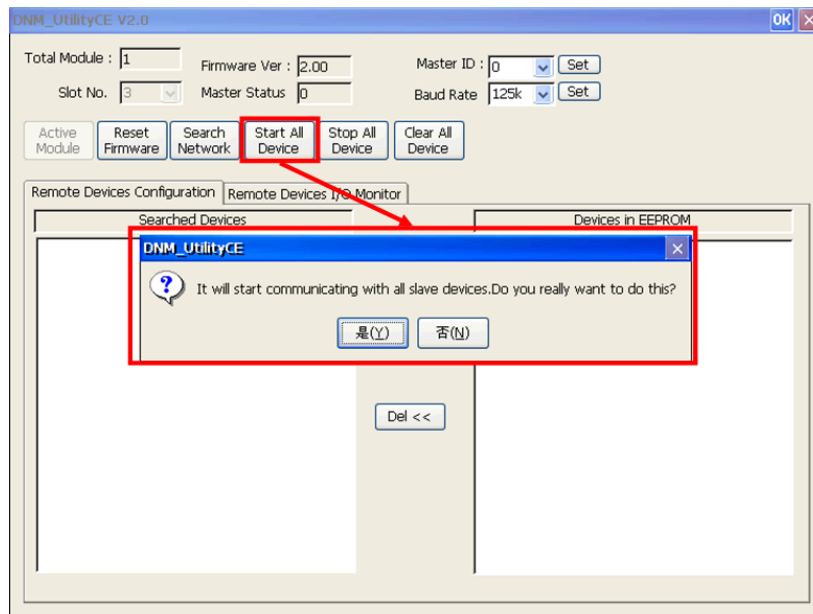

3. The users can click “Remote Device I/O Monitor” tag to view the I/O data of the slave devices.

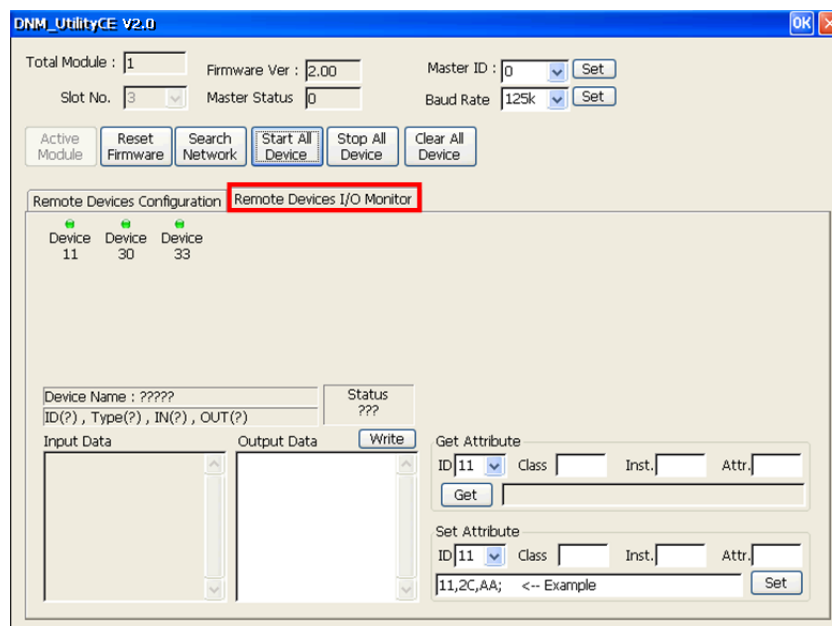

- Users can press the device No. to display the device information, including the device name and input data.

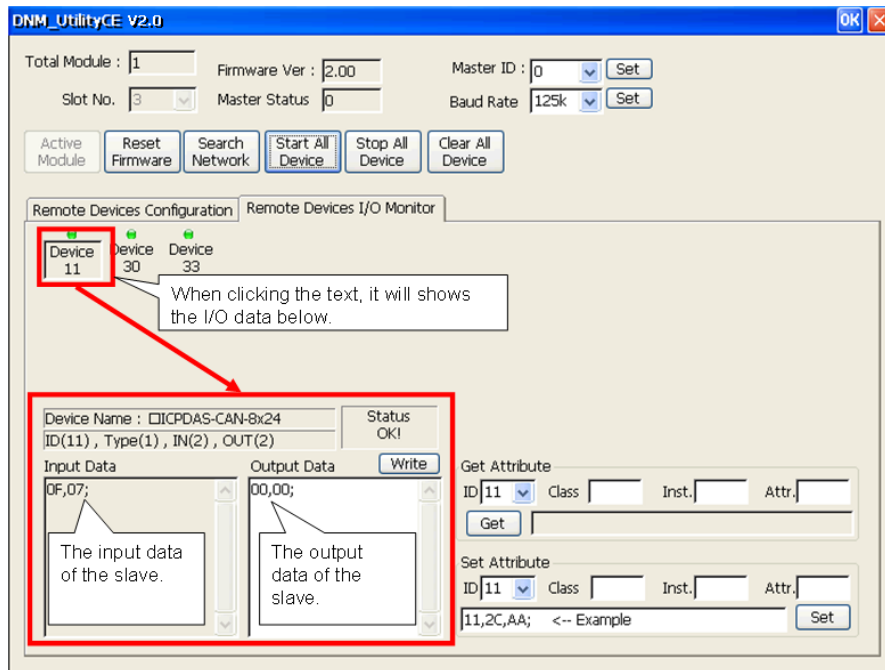

- Users can press “Write” button to send the output data to the slave device.

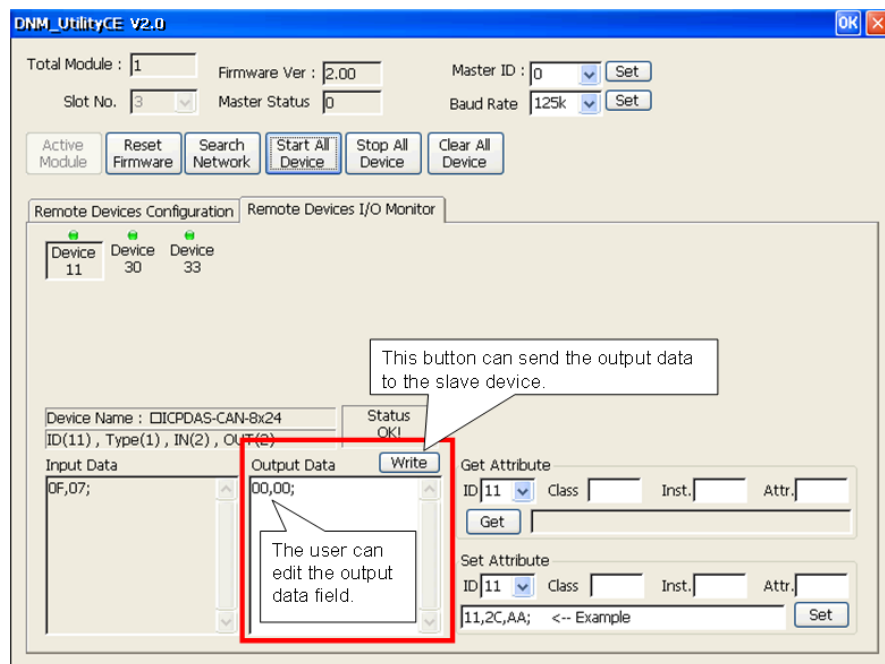

5.3 Description of the Buttons and Fields

Here is the description of the buttons in the software utility.

5.3.1 Total Module Number

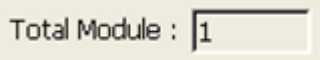

This field shows the total number of the I-8124W module in the WP-8000. The utility will detect the I-8124W hardware automatically when starting up. If the number is 0, users can not use this software. Please check the installation of the I-8124W module.

5.3.2 Slot Number



This shows which slot the I-8124W has been plugged in. The drop-down list will show the entire slots which the I-8124W module plugged in the WP-8000.

5.3.3 Active Module



This button could activate the I-8124W hardware which is selected in the “Slot No” field. Users should click this button before using other functions.

5.3.4 Reset Firmware



This button can restart the firmware of the I-8124W. If users have changed the baud rate or the MAC ID of the I-8124W, you must restart firmware to make the modification enable.

5.3.5 Search All Device



This button can search all the slave devices in the network.

Note: When the master is communicating with the slave devices, please don't use this function to avoid breaking the connection among the slave devices.

5.3.6 Start All Device



This button can start to communicate with all slave devices which have configured in the EEPROM.

Note: If the slave device contains output channels and the initial output value is not used, the master will send default value (0) to the output channels.

5.3.7 Stop All Device



This button would disconnect the communication with all slave devices which have configured in the EEPROM. All remote slave devices will change to the "off-line" state.

5.3.8 Clear All Device



This button can clear all configuration data in the EEPROM. The MAC ID of the master would be reset to 0 and the baud rate reset to 125K bps.

5.3.9 Write Output Data

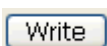

If users have started to communicate with the slave device, you can edit the "Output Data" field to change the value to the output channel. Finish the value modification, and press the "Write" button to send the new data to the slave device.

5.3.10 Change Master ID



If users want to change the MAC ID of the DeviceNet Master, you can select your own setting and then press the “Set” button. After changing the MAC ID, please reset firmware to make the modification enable.

5.3.11 Change Baud Rate



If users want to change the baud rate of the network, you can select your own setting and then press the “Set” button. After changing the baud rate, please reset firmware to make the modification enable.

5.3.12 Firmware Version

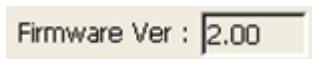

This field shows the firmware version.

5.3.13 Master Status

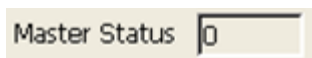

This field shows the current status of the I-8124W. Please refer to the chapter 4.2, the function return code, to explain the meanings of this field.