

# A71

## 4MP Outdoor Dome with D/N, Adaptive IR, Extreme WDR, SLLS, Fixed Lens



- 4 Megapixel
- Day & Night with Superior Low Light Sensitivity and Adaptive IR LED
- Fixed Lens with f2.8mm/F1.6
- Extreme WDR
- H.265 Compression
- Super wide angle
- Event trigger, response and notification

### ► Specifications

#### Device

Product Type	Dome
Maximum Resolution	4MP
Application Environment	Outdoor
Image Sensor	Progressive Scan CMOS
Sensor Size	1/2.7 "
Day / Night	Yes
Low Light Sensitivity	Superior
Minimum Illumination	Color: 0.01 lux; BW: 0.018 lux (IR LED on)
Color to B/W Switch	ISP based switch, configurable
Mechanical IR Cut Filter	Yes
IR LED	Adaptive IR LED (850 nm)
IR Working Distance	65m (1.0 lux)
Electronic Shutter	1/5-1/64000 second (manual mode); 1/5-1/64000 second (auto mode)

#### Lens

Focal Length	Fixed focal, f2.8mm
Aperture	F1.6

Iris	Fixed iris
Focus	Fixed focus
Lens Mount	Board mount
Horizontal Viewing Angle	103°
Vertical Viewing Angle	58°
Viewing Angle Adjustment	Pan: 0°-355°, Tilt: 0°-75°, Rotation: 0°-355°

## Video

Compression	H.265, H.264 (Main/ High profile), MJPEG
Maximum Frame Rate vs. Resolution	25 fps at 2688 x 1520 30 fps at 2560 x 1440 30 fps at 1920 x 1080 30 fps at 1280 x 960 30 fps at 1280 x 720 30 fps at 640 x 480
Multi-Streaming	Simultaneous quad streams
Bit Rate	128Kbps - 12Mbps (per stream)
Bit Rate Mode	Constant, Variable
Wide Dynamic Range	Extreme WDR (150 dB)
Image Enhancement	White Balance, Backlight compensation, Brightness, Contrast, Sharpness, Automatic gain control, Defogging
Digital Noise Reduction	3D DNR
Privacy Mask	Yes
Text Overlay	Yes
Built-in Analytics	Tampering Detection*, Face Detection*, Object Line Crossing Detection*, Object Enter Area Detection*
Server-based Analytics	Object Line Counting, People Counting, Face Detection, Object Based Motion Detection, Tamper, Object Line Crossing Detection, Object Enter Area Detection, Missing Object Detection, Unattended Object Detection, Smoke Detection, Heat Map, Dwell Time, Direction Detection, Automatic License Plate Recognition, People Queue Detection, (Require PC-based or standalone IVS or ALPR Server. Contact ACTi support for recommendations on how to maximize analytical accuracy)
Image Orientation	Flip, Mirror, Rotation

## Audio

Audio Type	2-way, Line-in, Mic-in, Line-out
Audio Compression	G.711

## Network

Network Protocol & Service	IPv4/v6, TCP, UDP, DHCP, PPPoE, HTTP, HTTPS, DNS, DDNS, NTP, RTP, RTSP, RTCP, SMTP, FTP, IGMP, ICMP, Bonjour, UPnP, QoS, SNMP, IEEE 802.1X
Ethernet Port	1, Ethernet (10/100 Base-T), RJ-45 connector
Security	IP address filtering, HTTPS encryption, Password protected user level, Anonymous login, IEEE 802.1X network access control

## Event

Event Trigger	Video motion detection (3 regions), External device through digital input, Sound detection, Tampering detection,
---------------	--

## Integration

GPS Position	Manual setting
ONVIF Compliant	Yes, Profile S, Profile G, Profile Q, Profile T

Web Browser	IE 11
Auto Firmware Upgrade	Yes

**Interface**

Audio Interface	1/1, Terminal block
Local Storage	MicroSD, MicroSDHC, MicroSDXC Memory Card Slot (card not included, up to 128GB)
Digital Input/Output	1/1 (Terminal block)

**General**

Power Source	DC 12V, PoE Class 3 (IEEE802.3af)
Power Consumption	6 W (DC), 7.5 W (PoE)
Weight	610g (1.3lb)
Dimensions	( $\varnothing$ x H): 111mm x 82.4mm (4.4" x 3.2")
Environmental Casing	Weatherproof (IP67), Vandal proof (IK10)
Operating Temperature	-30°C ~ 60°C (-22°F ~ 140°F)
Warranty	3 Year(s)

\* To be available through future firmware upgrade



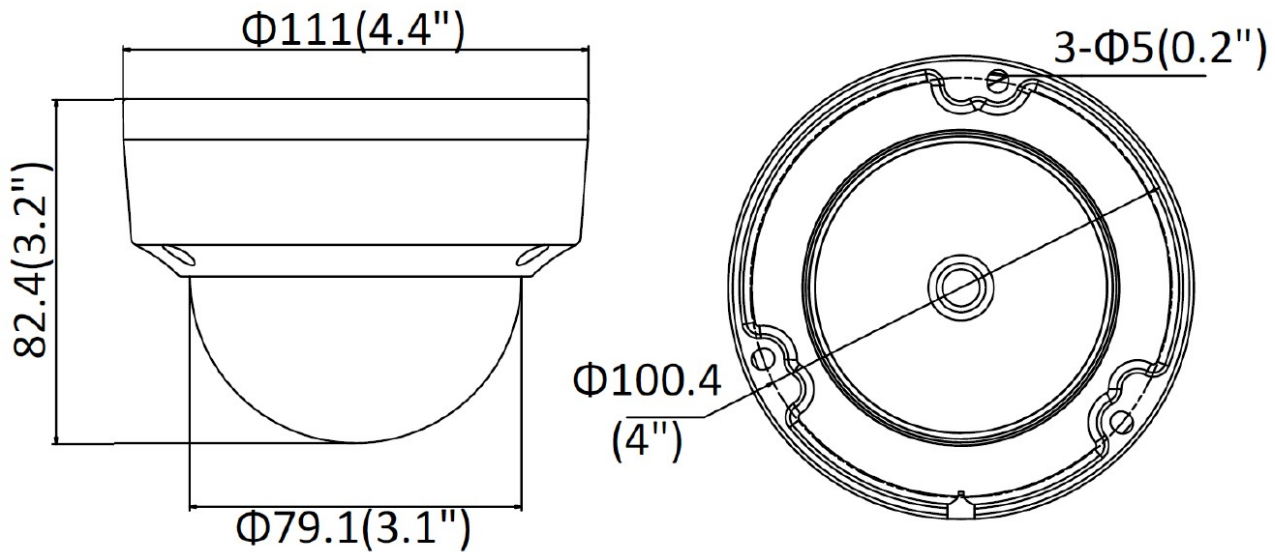



► **Dimension Diagram**



Unit: mm [inch]

## ▶ Related Products

### Mounting Accessories - Camera Mount

PMAX-0122		Straight Tube (for A71, A88, A9x,)
PMAX-0123		Extension Tube (for A71, A88, A9x,)
PMAX-0318		Wall Mount (for A91, A92, Z91, A61, A62)
PMAX-0523		Pole Mount (for A31, PMAX-0318), supports 2" to 3" Poles
PMAX-0718		Junction Box (for A71)
PMAX-0816		Converter Ring, 1.0" NPT for Third-Party Mounting Accessories, White
PMAX-1402		Mount Kit (for A91, A92, Z91, A61, A62, A71)

**Note:** Some mounting accessories may need additional accessories for installation. Please check [www.acti.com/mountingselector](http://www.acti.com/mountingselector) for more information.