



**NEXCOM International Co., Ltd.**

# **Intelligent Platform & Services Business Unit**

## **Wide Screen Touch Computer**

### **XPPC 10-200**

#### User Manual

# CONTENTS

## Preface

Copyright .....	iv
Disclaimer .....	iv
Acknowledgements .....	iv
Regulatory Compliance Statements .....	iv
Declaration of Conformity .....	iv
RoHS Compliance .....	v
Warranty and RMA .....	vi
Safety Information .....	viii
Installation Recommendations .....	viii
Safety Precautions .....	ix
Technical Support and Assistance .....	x
Conventions Used in this Manual .....	x
Global Service Contact Information .....	xi
Package Contents .....	xiii
Ordering Information .....	xiv

## Chapter 1: Product Introduction

XPPC 10-200 .....	1
Overview .....	1
Key Features .....	1
Hardware Specifications .....	2
Knowing Your XPPC 10-200 .....	4
Rear Bottom .....	4
Rear Top .....	4
Mechanical Dimensions .....	5

## Chapter 2: Jumpers and Connectors

Before You Begin .....	6
Precautions .....	6
Jumper Settings .....	7
Locations of the Jumpers and Connectors for XPPC 10-200 .....	8
Top View .....	8
Jumpers .....	9
LCD Panel Voltage Select .....	9
Clear CMOS .....	9
ATX/AT Mode Select .....	10
Connector Pin Definitions .....	11
External I/O Interfaces .....	11
MIC and Line Out Connector .....	11
Speaker Connector .....	11
System Power Button .....	12
Fan Connector .....	12
COM Port Connector .....	13
DC Power Input Jack (+12V only) .....	13
SATA Connector .....	14
HDMI .....	14
Connector type: HDMI port .....	14
Connector location: HDMI .....	14
LAN Connector .....	15
Connector type: RJ45 port with LEDs .....	15
Connector location: LAN1 .....	15
USB 3.0 Connector .....	15



- Connector type: Dual USB 3.0 ports ..... 15
- Connector location: USB3\_1 & USB3\_2 ..... 15
- Internal Connectors ..... 16
  - System Reset Button ..... 16
  - HDD LED Connector..... 16
  - Power LED Connector ..... 17
  - RI Connector..... 17
  - Battery Connector ..... 18
    - 12V Header..... 18
- USB 2.0 ..... 19
  - GPIO Connector..... 19
  - SATA Power Connector ..... 20
  - 80 Debug Port Connector ..... 20
  - eDP Connector..... 21
  - M.2 2280/2242 M-key ..... 22
  - M.2 2230 E-key ..... 23
- Block Diagram ..... 24

- Legends ..... 31
- BIOS Setup Utility ..... 33
  - Main ..... 33
  - Advanced ..... 34
  - Security ..... 42
  - Boot ..... 43
  - Save & Exit ..... 44

### Chapter 3: System Setup

- Removing the Top Cover from the Chassis ..... 25
- Installing DDR, SSD, WiFi module..... 25
- Installing VESA Mount Kit ..... 26
- Installing Open Frame Kit..... 26
- System Dimensions with Open Frame Kit ..... 27
- Panel Mounting ..... 28

### Chapter 4: BIOS Setup

- About BIOS Setup ..... 30
- When to Configure the BIOS..... 30
- Default Configuration ..... 31
- Entering Setup ..... 31

# PREFACE

## Copyright

This publication, including all photographs, illustrations and software, is protected under international copyright laws, with all rights reserved. No part of this manual may be reproduced, copied, translated or transmitted in any form or by any means without the prior written consent from NEXCOM International Co., Ltd.

## Disclaimer

The information in this document is subject to change without prior notice and does not represent commitment from NEXCOM International Co., Ltd. However, users may update their knowledge of any product in use by constantly checking its manual posted on our website: <http://www.nexcom.com>. NEXCOM shall not be liable for direct, indirect, special, incidental, or consequential damages arising out of the use of any product, nor for any infringements upon the rights of third parties, which may result from such use. Any implied warranties of merchantability or fitness for any particular purpose is also disclaimed.

## Acknowledgements

XPPC 10-200 is a trademark of NEXCOM International Co., Ltd. All other product names mentioned herein are registered trademarks of their respective owners.

## Regulatory Compliance Statements

This section provides the FCC compliance statement for Class A devices and describes how to keep the system CE compliant.

## Declaration of Conformity

### FCC

This equipment has been tested and verified to comply with the limits for a Class A digital device, pursuant to Part 15 of FCC Rules. These limits are designed to provide reasonable protection against harmful interference when the equipment is operated in a commercial environment. This equipment generates, uses, and can radiate radio frequency energy and, if not installed and used in accordance with the instructions, may cause harmful interference to radio communications. Operation of this equipment in a residential area (domestic environment) is likely to cause harmful interference, in which case the user will be required to correct the interference (take adequate measures) at their own expense.

### CE

The product(s) described in this manual complies with all applicable European Union (CE) directives if it has a CE marking. For computer systems to remain CE compliant, only CE-compliant parts may be used. Maintaining CE compliance also requires proper cable and cabling techniques.

## RoHS Compliance



### **NEXCOM RoHS Environmental Policy and Status Update**

NEXCOM is a global citizen for building the digital infrastructure. We are committed to providing green products and services, which are compliant with European Union RoHS (Restriction on Use of Hazardous Substance in Electronic Equipment) directive 2011/65/EU, to be your trusted green partner and to protect our environment.

RoHS restricts the use of Lead (Pb) < 0.1% or 1,000ppm, Mercury (Hg) < 0.1% or 1,000ppm, Cadmium (Cd) < 0.01% or 100ppm, Hexavalent Chromium (Cr6+) < 0.1% or 1,000ppm, Polybrominated biphenyls (PBB) < 0.1% or 1,000ppm, and Polybrominated diphenyl Ethers (PBDE) < 0.1% or 1,000ppm.

In order to meet the RoHS compliant directives, NEXCOM has established an engineering and manufacturing task force to implement the introduction of green products. The task force will ensure that we follow the standard NEXCOM development procedure and that all the new RoHS components and new manufacturing processes maintain the highest industry quality levels for which NEXCOM are renowned.

The model selection criteria will be based on market demand. Vendors and suppliers will ensure that all designed components will be RoHS compliant.

### **How to recognize NEXCOM RoHS Products?**

For existing products where there are non-RoHS and RoHS versions, the suffix "(LF)" will be added to the compliant product name.

All new product models launched after January 2013 will be RoHS compliant. They will use the usual NEXCOM naming convention.

## Warranty and RMA

### NEXCOM Warranty Period

NEXCOM manufactures products that are new or equivalent to new in accordance with industry standard. NEXCOM warrants that products will be free from defect in material and workmanship for 2 years, beginning on the date of invoice by NEXCOM.

### NEXCOM Return Merchandise Authorization (RMA)

- Customers shall enclose the “NEXCOM RMA Service Form” with the returned packages.
- Customers must collect all the information about the problems encountered and note anything abnormal or, print out any on-screen messages, and describe the problems on the “NEXCOM RMA Service Form” for the RMA number apply process.
- Customers can send back the faulty products with or without accessories (manuals, cable, etc.) and any components from the card, such as CPU and RAM. If the components were suspected as part of the problems, please note clearly which components are included. Otherwise, NEXCOM is not responsible for the devices/parts.
- Customers are responsible for the safe packaging of defective products, making sure it is durable enough to be resistant against further damage and deterioration during transportation. In case of damages occurred during transportation, the repair is treated as “Out of Warranty.”
- Any products returned by NEXCOM to other locations besides the customers’ site will bear an extra charge and will be billed to the customer.

### Repair Service Charges for Out-of-Warranty Products

NEXCOM will charge for out-of-warranty products in two categories, one is basic diagnostic fee and another is component (product) fee.

#### System Level

- Component fee: NEXCOM will only charge for main components such as SMD chip, BGA chip, etc. Passive components will be repaired for free, ex: resistor, capacitor.
- Items will be replaced with NEXCOM products if the original one cannot be repaired. Ex: motherboard, power supply, etc.
- Replace with 3rd party products if needed.
- If RMA goods can not be repaired, NEXCOM will return it to the customer without any charge.

#### Board Level

- Component fee: NEXCOM will only charge for main components, such as SMD chip, BGA chip, etc. Passive components will be repaired for free, ex: resistors, capacitors.
- If RMA goods can not be repaired, NEXCOM will return it to the customer without any charge.

## Warnings

Read and adhere to all warnings, cautions, and notices in this guide and the documentation supplied with the chassis, power supply, and accessory modules. If the instructions for the chassis and power supply are inconsistent with these instructions or the instructions for accessory modules, contact the supplier to find out how you can ensure that your computer meets safety and regulatory requirements.

## Cautions

Electrostatic discharge (ESD) can damage system components. Do the described procedures only at an ESD workstation. If no such station is available, you can provide some ESD protection by wearing an antistatic wrist strap and attaching it to a metal part of the computer chassis.

## Safety Information

Before installing and using the device, note the following precautions:

- Read all instructions carefully.
- Do not place the unit on an unstable surface, cart, or stand.
- Follow all warnings and cautions in this manual.
- When replacing parts, ensure that your service technician uses parts specified by the manufacturer.
- Avoid using the system near water, in direct sunlight, or near a heating device.
- The load of the system unit does not solely rely for support from the rackmounts located on the sides. Firm support from the bottom is highly necessary in order to provide balance stability.
- The computer is provided with a battery-powered real-time clock circuit. There is a danger of explosion if battery is incorrectly replaced. Replace only with the same or equivalent type recommended by the manufacturer. Discard used batteries according to the manufacturer's instructions.

## Installation Recommendations

Ensure you have a stable, clean working environment. Dust and dirt can get into components and cause a malfunction. Use containers to keep small components separated.

Adequate lighting and proper tools can prevent you from accidentally damaging the internal components. Most of the procedures that follow require only a few simple tools, including the following:

- A Philips screwdriver
- A flat-tipped screwdriver
- A grounding strap
- An anti-static pad

Using your fingers can disconnect most of the connections. It is recommended that you do not use needle-nose pliers to disconnect connections as these can damage the soft metal or plastic parts of the connectors.



## Safety Precautions

1. Read these safety instructions carefully.
2. Keep this User Manual for later reference.
3. Disconnect this equipment from any AC outlet before cleaning. Use a damp cloth. Do not use liquid or spray detergents for cleaning.
4. For plug-in equipment, the power outlet socket must be located near the equipment and must be easily accessible.
5. Keep this equipment away from humidity.
6. Put this equipment on a stable surface during installation. Dropping it or letting it fall may cause damage.
7. The openings on the enclosure are for air convection to protect the equipment from overheating. DO NOT COVER THE OPENINGS.
8. Make sure the voltage of the power source is correct before connecting the equipment to the power outlet.
9. Place the power cord in a way so that people will not step on it. Do not place anything on top of the power cord. Use a power cord that has been approved for use with the product and that it matches the voltage and current marked on the product's electrical range label. The voltage and current rating of the cord must be greater than the voltage and current rating marked on the product.
10. All cautions and warnings on the equipment should be noted.
11. If the equipment is not used for a long time, disconnect it from the power source to avoid damage by transient overvoltage.
12. Never pour any liquid into an opening. This may cause fire or electrical shock.
13. Never open the equipment. For safety reasons, the equipment should be opened only by qualified service personnel.
14. If one of the following situations arises, get the equipment checked by service personnel:
  - a. The power cord or plug is damaged.
  - b. Liquid has penetrated into the equipment.
  - c. The equipment has been exposed to moisture.
  - d. The equipment does not work well, or you cannot get it to work according to the user's manual.
  - e. The equipment has been dropped and damaged.
  - f. The equipment has obvious signs of breakage.
15. Do not place heavy objects on the equipment.
16. The unit uses a three-wire ground cable which is equipped with a third pin to ground the unit and prevent electric shock. Do not defeat the purpose of this pin. If your outlet does not support this kind of plug, contact your electrician to replace your obsolete outlet.
17. **ATTENTION:** Risque d'explosion si la batterie est remplacée par un type incorrect. Mettre au rebus les batteries usagées selon les instructions.

**CAUTION:** Risk of explosion if battery is replaced by an incorrect type. Dispose of used batteries according to the instructions.

## Technical Support and Assistance

1. For the most updated information of NEXCOM products, visit NEXCOM's website at [www.nexcom.com](http://www.nexcom.com).
2. For technical issues that require contacting our technical support team or sales representative, please have the following information ready before calling:
  - Product name and serial number
  - Detailed information of the peripheral devices
  - Detailed information of the installed software (operating system, version, application software, etc.)
  - A complete description of the problem
  - The exact wordings of the error messages

### Warning!

1. Handling the unit: carry the unit with both hands and handle it with care.
2. Maintenance: to keep the unit clean, use only approved cleaning products or clean with a dry cloth.

## Conventions Used in this Manual



### Warning:

Information about certain situations, which if not observed, can cause personal injury. This will prevent injury to yourself when performing a task.



### Caution:

Information to avoid damaging components or losing data.



### Note:

Provides additional information to complete a task easily.

## Global Service Contact Information

### Headquarters

#### **NEXCOM International Co., Ltd.**

9F, No. 920, Chung-Cheng Rd.,  
ZhongHe District, New Taipei City, 23586,  
Taiwan, R.O.C.

Tel: +886-2-8226-7786

Fax: +886-2-8226-7782

[www.nexcom.com](http://www.nexcom.com)

### Asia

#### Taiwan

#### **NexAIoT Co., Ltd.**

#### **Taipei Office**

13F, No.920, Chung-Cheng Rd.,  
ZhongHe District,  
New Taipei City, 23586, Taiwan, R.O.C.

Tel: +886-2-8226-7796

Fax: +886-2-8226-7792

Email: [sales@nexcom.com.tw](mailto:sales@nexcom.com.tw)

[www.nexcom.com.tw](http://www.nexcom.com.tw)

#### **NexAIoT Co., Ltd.**

#### **Taichung Office**

16F, No.250, Sec. 2, Chongde Rd.,  
Beitun Dist.,

Taichung City 406, R.O.C.

Tel: +886-4-2249-1179

Fax: +886-4-2249-1172

Email: [sales@nexcom.com.tw](mailto:sales@nexcom.com.tw)

[www.nexcom.com.tw](http://www.nexcom.com.tw)

#### **NexCOBOT Taiwan Co., Ltd.**

13F, No.916, Chung-Cheng Rd.,  
ZhongHe District,  
New Taipei City, 23586, Taiwan, R.O.C.

Tel: +886-2-8226-7796

Fax: +886-2-8226-7792

Email: [sales@nexcom.com.tw](mailto:sales@nexcom.com.tw)

[www.nexcom.com.tw](http://www.nexcom.com.tw)

#### **GreenBase Technology Corp.**

13F, No.922, Chung-Cheng Rd.,  
Zhonghe Dist.,  
New Taipei City, 23586, Taiwan, R.O.C.

Tel: +886-2-8226-7786

Fax: +886-2-8226-7900

Email: [sales@nexcom.com.tw](mailto:sales@nexcom.com.tw)

[www.nexcom.com.tw](http://www.nexcom.com.tw)

### China

#### **NEXSEC Incorporated**

Floor 5, No.4, No.7 fengxian middle Rd.,  
(Beike Industrial Park), Haidian District,  
Beijing, 100094, China

Tel: +86-10-5704-2680

Fax: +86-10-5704-2681

Email: [sales@nexcom.cn](mailto:sales@nexcom.cn)

[www.nexcom.cn](http://www.nexcom.cn)

**NEXCOM Shanghai**

Room 603/604, Huiyinmingzun Plaza Bldg., 1,  
No. 609, Yunlin East Rd.,  
Shanghai, 200062, China  
Tel: +86-21-5278-5868  
Fax: +86-21-3251-6358  
Email: sales@nexcom.cn  
www.nexcom.cn

**NEXCOM Surveillance Technology Corp.**

Floor 5, Building C, ZhenHan Industrial Zone,  
GanKeng Community, Buji Street,  
LongGang District,  
ShenZhen, 518112, China  
Tel: +86-755-8364-7768  
Fax: +86-755-8364-7738  
Email: steveyang@nexcom.com.tw  
www.nexcom.cn

**NEXCOM United System Service**

Room 603/604, Huiyinmingzun Plaza Bldg. 1,  
No. 609, Yunlin East Rd.,  
Shanghai, 200062, China  
Tel: +86-21-5278-5868  
Fax: +86-21-3251-6358  
Email: renwang@nexcom.com.tw  
www.nexcom.cn

**NEXGOL**

1st Floor, Building B4, Electronic 2nd Area,  
(Phoenix Lake Industrial Park), Yongchuan Dist.,  
Chongqing City, 402160, China  
Tel: +86-23-4960-9080  
Fax: +86-23-4966-5855  
Email: sales@nexcobot.com  
www.nexgol.com/NexGoL

**Beijing NexGemo Technology Co.,Ltd.**

5th Floor, Gemotech Building, No.1, Development Rd.,  
Changping International Information Industry Base,  
Changping District,  
Beijing, 102206, China  
Tel: +86-10-8190-9399  
Fax: +86-10-8190-9456

**Japan****NEXCOM Japan**

9F, Tamachi Hara Bldg.,  
4-11-5, Shiba Minato-ku,  
Tokyo, 108-0014, Japan  
Tel: +81-3-5419-7830  
Fax: +81-3-5419-7832  
Email: sales@nexcom-jp.com  
www.nexcom-jp.com

**Europe****United Kingdom  
NEXCOM EUROPE**

10 Vincent Avenue,  
Crownhill Business Centre,  
Milton Keynes, Buckinghamshire  
MK8 0AB, United Kingdom  
Tel: +44-1908-267121  
Fax: +44-1908-262042  
Email: sales.uk@nexcom.eu  
www.nexcom.eu

**America****USA  
NEXCOM USA**

46665 Fremont Blvd.,  
Fremont CA 94538, USA  
Tel: +1-510-656-2248  
Fax: +1-510-656-2158  
Email: sales@nexcom.com  
www.nexcomusa.com

## Package Contents

Before continuing, verify that the XPPC 10-200 package that you received is complete. Your package should have all the items listed in the following table.

Item	Part Number	Name	Qty
1	10W30XPPC19X0	XPPC10-200-i3 ASSY	1
2	7400060049X00	Power Adapter FSP:FSP060-DHAN3(9NA0608046)	1

Item	Part Number	Name	Qty
1	10W30XPPC20X0	XPPC16-200-i5 ASSY	1
2	7400060049X00	Power Adapter FSP:FSP060-DHAN3(9NA0608064)	1

### Optional Accessories 1

Item	Part Number	Name	Description	Qty
1	5040420202X00	Panel Mount Bracket	Panel Mount BKT for XPPC Series VER:A SIN 30x20x6mm SPCC T=1.6mm NI	10
2	50311F0326X00	Screw	Flat Head Screw Long Fei:F3x5 Nylok NI+Heat Treatment	10

### Optional Accessories 2

Item	Part Number	Name	Description	Qty
1	5040420219X00	Open Frame Bracket	Open Frame Bracket for XPPC 16-100 VER:A	2
2	50311F0326X00	Screw	Flat Head Screw Long Fei:F3x5 Nylok NI+Heat Treatment	4

## Ordering Information

The following below provides ordering information for XPPC 10-200.

### **XPPC 10-200-i3 (P/N:10W30XPPC19X0)**

10.1" WXGA LED P-CAP touch computer, Intel® Tiger Lake  
Core i3-1115G4E

### **XPPC 10-200-i5 (P/N:10W30XPPC20X0 )**

10.1" WXGA LED P-CAP touch computer, Intel® Tiger Lake  
Core i5-1145G7E

### **Panel Mount Kit (P/N: 88W30XPPC02X0)**

### **Open Frame Kit (P/N: 88W30XPPC03X0)**

# CHAPTER 1: PRODUCT INTRODUCTION

## XPPC 10-200

### Overview



### Key Features

- 10.1" TFT WXGA 16:10 panel
- 10 points P-Cap multi-touch with slim bezel design
- IP65 protection on the front
- Support: VESA/panel/open frame mount
- 11th Generation Intel® Tiger Lake-UP3 Core™ processor SoC
- 1 x 260-pin DDR4 SO-DIMM up to 32G
- Onboard M.2 2280 Key M with PCIe x4 signal for storage module
- Onboard M.2 2230 Key E for optional Wi-Fi modules
- Support power input 12 VDC

## Hardware Specifications

### Panel

- LCD size: AUO G-series 10.1", 16:10
- Resolution: WXGA 1280 x 800
- Luminance
  - LCD panel: 400cd/m<sup>2</sup>
  - XPPC PCAP touch: 360cd/m<sup>2</sup>
- Contrast ratio: 800
- LCD color: 16.7M
- Viewing angle: 89 (U), 89 (D), 89 (L), 89 (R)

### Touch Screen

- 10 points P-Cap (projected capacitive touch)
- Optical bonding
- Glass surface treatment: AS (Anti-Smudge Coating for easy cleaning)

### System

- Onboard 11th Generation Intel® Core™ i3-1115G4E processor, dual core, 2.2 GHz base frequency, 6M cache (formerly Tiger Lake-UP3 )
- Intel® UHD graphics 630 on i3 processor
- Onboard 11th Generation Intel® Core™ i5-1145G7E processor, dual core, 1.5 GHz base frequency, 8M cache (by request)
- Intel® Iris® Xe graphics on i5 processor

### Main Memory

- 1 x 260-pin DDR4 SO-DIMM, supports non-ECC, un-buffered memory up to 32G

### Storage Device

- 1 x M.2 M key 2280 (support PCIe x4)

### Expansion

- 1 x M.2 2230 Key E, support optional Wi-Fi modules

### Rear I/O

- 1 x RS232/422/485
- 1 x 12V DC Jack
- 2 x RJ45 Intel® Gigabit LAN port
- 1 x HDMI 2.0
- 4 x USB 3.0
- 1 x Line-out
- LED for power on/off
- Power switch

### Front I/O

- 2 x Antenna holes

### Mechanical

- Color/material: black silver/metal sheet
- Support
  - VESA mount 100mm x 100mm
  - Panel mount
  - Open frame

### Environment

- Vibration
  - IEC 68 2-64
  - 2Grms @ sine, 5~500Hz, 1hr/axis
  - 2.2Grms @ random condition, 5~500Hz, 0.5hr/axis (non-operating)



- Shock
  - IEC 68 2-27
  - 50g peak acceleration (11 msec. duration)
- Temperature
  - Operating temperature: 0°C~50°C
  - Storage temperature: -20°C~60°C
- Operating humidity: 10%~90% relative humidity, non-condensing limits to be at 90%

### Dimensions

- System: 260.3mm x 178.3mm x 50.4mm
- System weight: 2.0kg
- Package: 335mm x 302mm x 160mm
- Package weight: 3kg

### Power Supply

- 1 x External 60W AC/DC power adapter with lock (power adapter is included in accessory)
- Input: 100VAC to 240VAC
- Output: DC+12VDC

### Certification

- CE (EN55035 + EN55032)
- FCC Class A (EMI part 15B)
- LVD (EN62368-1)

### Operating System Support

- Windows 10 64-bit
- Linux

## Knowing Your XPPC 10-200

### Rear Top

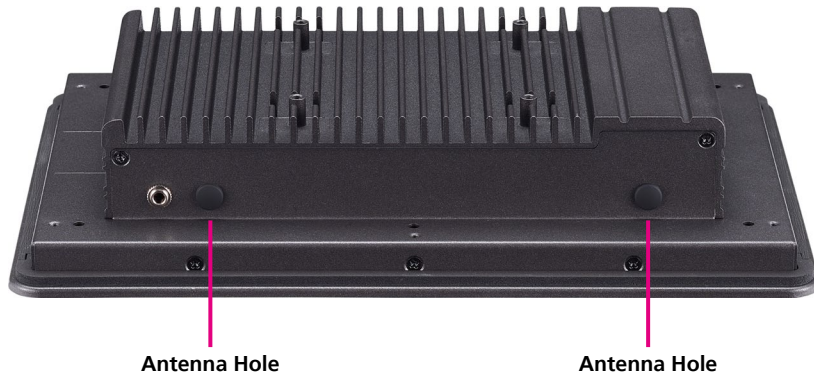

### Rear Bottom

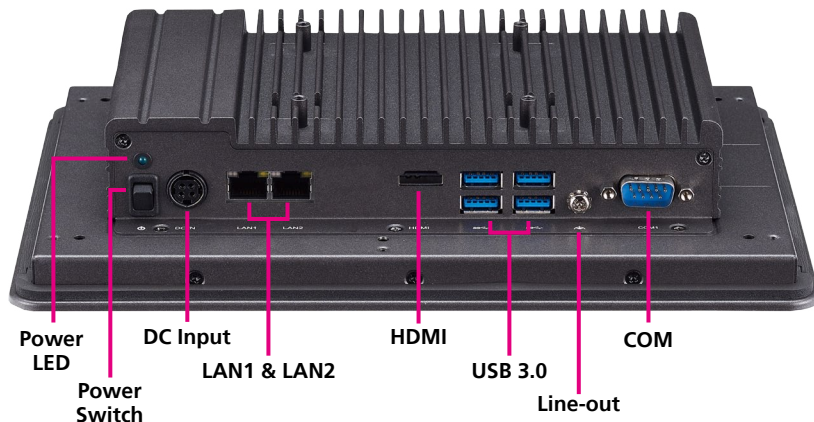

#### Antenna Holes

The external antenna mounting holes are used to mount and connect optional Wi-Fi antennas.

#### Power LED

Used to indicate the power status of the system.

#### Power Switch

Press to power-on or power-off the system.

#### 12V DC Input

Used to plug a DC power cord.

#### LAN1 & LAN2

Used to connect the system to a local area network.

#### HDMI 2.0

Used to connect an HDMI interface monitor.

#### USB 3.0

Used to connect USB 3.0/2.0 devices.

#### Line-out

Used to connect a headphone or a speaker.

#### COM

DB9 port used to connect RS232/422/485 compatible devices.

# Mechanical Dimensions

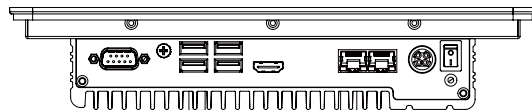
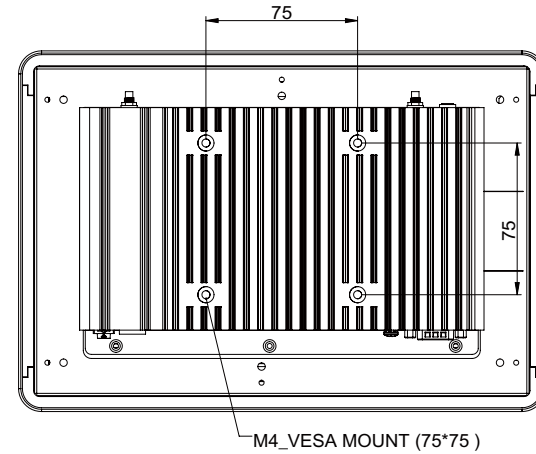
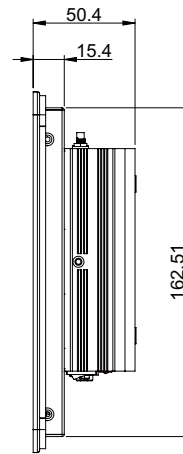
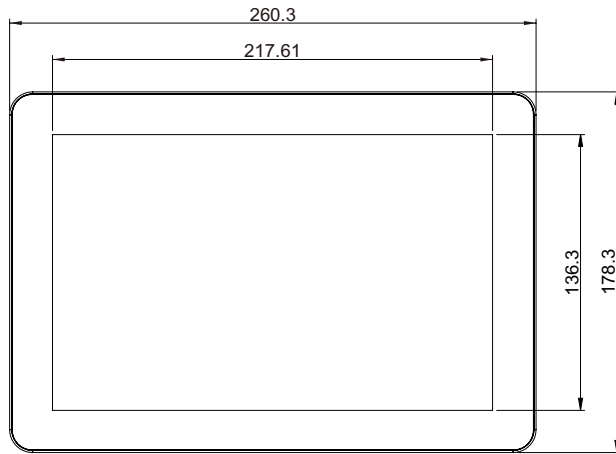
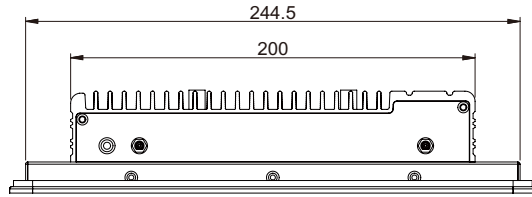

## CHAPTER 2: JUMPERS AND CONNECTORS

This chapter describes how to set the jumpers and connectors on the XPPC 10-200 motherboard.

### Before You Begin

- Ensure you have a stable, clean working environment. Dust and dirt can get into components and cause a malfunction. Use containers to keep small components separated.
- Adequate lighting and proper tools can prevent you from accidentally damaging the internal components. Most of the procedures that follow require only a few simple tools, including the following:
  - A Philips screwdriver
  - A flat-tipped screwdriver
  - A set of jewelers screwdrivers
  - A grounding strap
  - An anti-static pad
- Using your fingers can disconnect most of the connections. It is recommended that you do not use needle-nosed pliers to disconnect connections as these can damage the soft metal or plastic parts of the connectors.
- Before working on internal components, make sure that the power is off. Ground yourself before touching any internal components, by touching a metal object. Static electricity can damage many of the electronic components. Humid environments tend to have less static electricity than

dry environments. A grounding strap is warranted whenever danger of static electricity exists.

### Precautions

Computer components and electronic circuit boards can be damaged by discharges of static electricity. Working on computers that are still connected to a power supply can be extremely dangerous.

Follow the guidelines below to avoid damage to your computer or yourself:

- Always disconnect the unit from the power outlet whenever you are working inside the case.
- If possible, wear a grounded wrist strap when you are working inside the computer case. Alternatively, discharge any static electricity by touching the bare metal chassis of the unit case, or the bare metal body of any other grounded appliance.
- Hold electronic circuit boards by the edges only. Do not touch the components on the board unless it is necessary to do so. Don't flex or stress the circuit board.
- Leave all components inside the static-proof packaging that they shipped with until they are ready for installation.
- Use correct screws and do not over tighten screws.

## Jumper Settings

A jumper is the simplest kind of electric switch. It consists of two metal pins and a cap. When setting the jumpers, ensure that the jumper caps are placed on the correct pins. When the jumper cap is placed on both pins, the jumper is short. If you remove the jumper cap, or place the jumper cap on just one pin, the jumper is open.

Refer to the illustrations below for examples of what the 2-pin and 3-pin jumpers look like when they are short (on) and open (off).

Two-Pin Jumpers: Open (Left) and Short (Right)

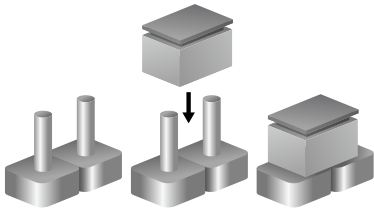

Three-Pin Jumpers: Pins 1 and 2 are Short

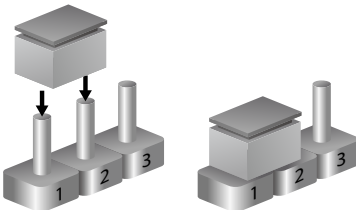

## Locations of the Jumpers and Connectors for XPPC 10-200

The figure below is the top and bottom view of the mainboard used in XPPC 10-200. It shows the locations of the jumpers and connectors.

Top View

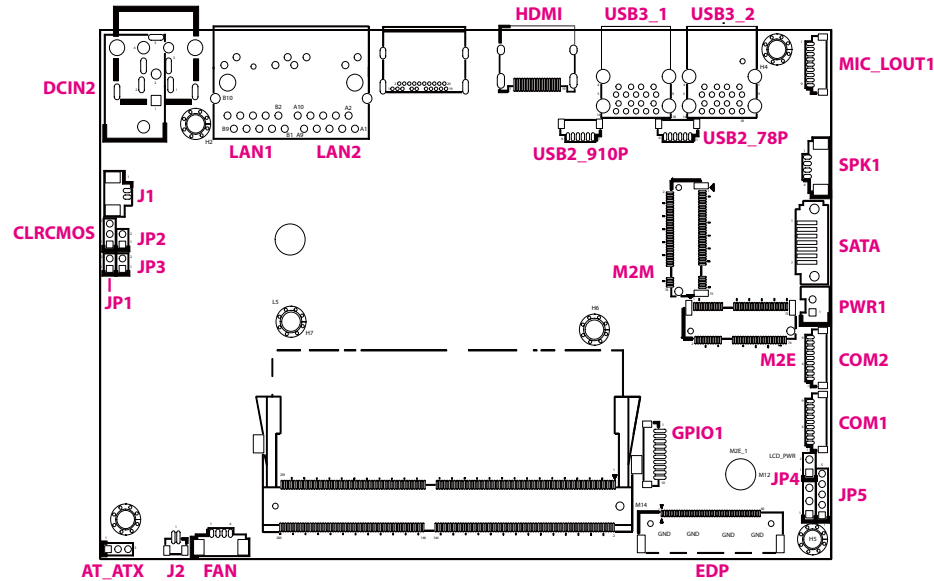

## Jumpers

### LCD Panel Voltage Select

Connector type: 1x3 3-pin header, 2.54mm pitch

Connector location: LCD\_PWR



Pin	Settings
1-2 On	3.3V
2-3 On	5V

1-2 On: default

### Clear CMOS

Connector type: 1x3 3-pin header, 2.0mm pitch

Connector location: CLR CMOS

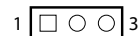

Pin	Settings
1-2 On	Normal
2-3 On	Clear CMOS

1-2 On: default

## ATX/AT Mode Select

Connector type: 1x3 3-pin header, 2.0mm pitch  
Connector location: AT\_ATX



Pin	Settings
1-2 On	AT
2-3 On	ATX

2-3 On: default



## Connector Pin Definitions

### External I/O Interfaces

#### MIC and Line Out Connector

Connector location: MIC\_LOUT1

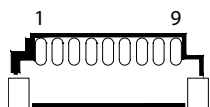

Pin	Definition	Pin	Definition
1	LOUT_R	2	LOUT_JD
3	GND	4	LOUT_L
5	GND	6	MIC_R
7	MIC_JD	8	MIC_L
9	GND		

#### Speaker Connector

Connector location: SPK1

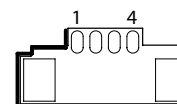

Pin	Definition	Pin	Definition
1	OUT_L+	2	OUT_L-
3	OUT_R+	4	OUT_R-

## System Power Button

Connector type: 1x2 2-pin header

Connector location: J2

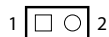

Pin	Settings
1	GND
2	PWRBTN#

## Fan Connector

Connector type: 1x4 4-pin header, 1.25mm pitch

Connector location: FAN1

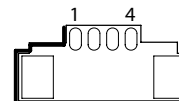

Pin	Definition	Pin	Definition
1	GND	2	+12V
3	FAN SPEED DETECT	4	FAN SPEED CONTROL

## COM Port Connector

Connector type: 1x9 9-pin header, 1.0mm pitch  
Connector location: COM1 & COM2

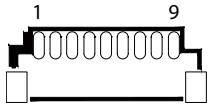

Pin	Definition	Pin	Definition
1	RI	2	CTS
3	RTS	4	DSR
5	GND	6	DTR
7	TXD	8	RXD
9	DCD		

## DC Power Input Jack (+12V only)

Connector location: DCIN2

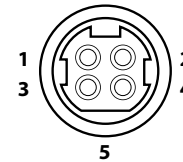

Pin	Definition	Pin	Definition
1	+12VSUS	2	+12VSUS
3	GND	4	GND
5	CGND		

## SATA Connector

Connector location: SATA

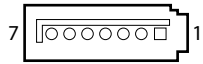

Pin	Definition	Pin	Definition
1	GND	2	SATA_TXP
3	SATA_TXN	4	GND
5	SATA_RXN	6	SATA_RXP
7	GND		

## HDMI

Connector type: HDMI port

Connector location: HDMI

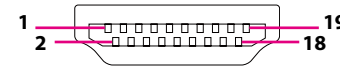

Pin	Definition	Pin	Definition
1	TX2P	2	GND
3	TX2N	4	TX1P
5	GND	6	TX1N
7	TX0P	8	GND
9	TX0N	10	CLKP
11	GND	12	CLKN
13	NC	14	NC
15	SCL	16	SDA
17	GND	18	+5V
19	HPD		

## LAN Connector

Connector type: RJ45 port with LEDs  
Connector location: LAN1

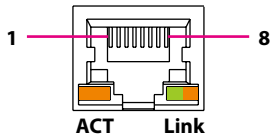

Pin	Definition	Pin	Definition
1	MDI_OP	2	MDI_ON
3	MDI_1P	4	MDI_1N
5	MDI_2P	6	MDI_2N
7	MDI_3P	8	MDI_3N
9	CT	10	GND
11	LINK1000#	12	LINK100#
13	ACTLED#	14	+3VSB

## USB 3.0 Connector

Connector type: Dual USB 3.0 ports  
Connector location: USB3\_1 & USB3\_2

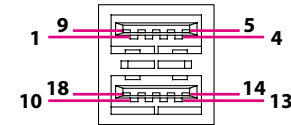

Pin	Definition	Pin	Definition
1	+5V	2	USB2_1N
3	USB2_1P	4	GND
5	USB3_RX1N	6	USB3_RX1P
7	GND	8	USB3_TX1N
9	USB3_TX1P	10	+5V
11	USB2_2N	12	USB2_2P
13	GND	14	USB3_RX2N
15	USB3_RX2P	16	GND
17	USB3_TX2N	18	USB3_TX2P

## Internal Connectors

### System Reset Button

Connector type: 1x2 2-pin header, 2.0mm pitch

Connector location: JP3

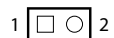

Pin	Settings
1	GND
2	RESET#

### HDD LED Connector

Connector type: 1x2 2-pin header, 2.0mm pitch

Connector location: JP2

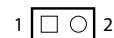

Pin	Settings
1	HDD_LED+
2	HDD_LED-

## Power LED Connector

Connector type: 1x2 2-pin header, 2.0mm pitch

Connector location: JP1

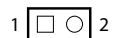

Pin	Settings
1	PWR_LED-
2	PWR_LED+

## RI Connector

Connector type: 1x5 5-pin header, 2.0mm pitch

Connector location: JP5

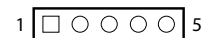

Pin	Definition	Pin	Definition
1	RI1	2	COM1_RI
3	+5V	4	COM1_RI
5	+12V		

## Battery Connector

Connector type: 1x2 2-pin header, 1.25mm pitch

Connector location: J1

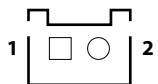

Pin	Settings
1	GND
2	BAT

## 12V Header

Connector type: 1x2 2-pin header, 2.0mm pitch

Connector location: JP4

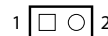

Pin	Settings
1	12V
2	GND



## USB 2.0

Connector type: Internal dual USB 2.0 ports

Connector location: USB2\_78P1 & USB2\_910P1

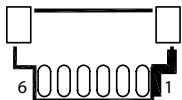

Pin	Definition	Pin	Definition
1	GND	2	USB2N
3	USB2P	4	USB1N
5	USB1P	6	+5V

## GPIO Connector

Connector location: GPIO1

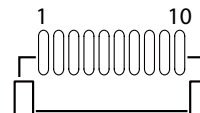

Pin	Definition	Pin	Definition
1	+5V	2	GND
3	12C_CLK	4	I2C_DATA
5	GPIO_PIN5	6	GPIO_PIN6
7	GPIO_PIN7	8	GPIO_PIN8
9	GPIO_PIN9	10	GPIO_PIN10

## SATA Power Connector

Connector type: 1x2 2-pin header, 2.5mm pitch

Connector location: PWR1

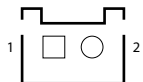

Pin	Definition
1	+5V
2	GND

## 80 Debug Port Connector

Connector type: 1x10 10-pin header, 1.0mm pitch

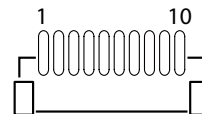

Pin	Definition	Pin	Definition
1	GND	2	PLTRST#
3	EPSI_CLK	4	ESPI_CS#
5	ESPI_IO3	6	ESPI_IO2
7	ESPI_IO2	8	ESPI_IO0
9	ESPI_RST#	10	3.3V

## eDP Connector

Connector location: EDP1

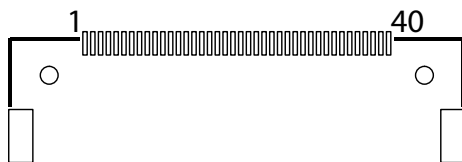

Pin	Definition	Pin	Definition
1	EDP_D3-	2	EDP_D3+
3	GND	4	EDP_D2-
5	EDP_D2+	6	GND
7	EDP_D1-	8	EDP_D1+
9	GND	10	EDP_D0-
11	EDP_D0+	12	GND
13	NC	14	NC
15	NC	16	NC
17	GND	18	+V_PANEL (3.3V or 5V)
19	+V_PANEL (3.3V or 5V)	20	+V_PANEL (3.3V or 5V)
21	GND	22	NC
23	GND	24	GND
25	GND	26	EDP_AUXP
27	EDP_AUXN	28	GND
29	GND	30	GND
31	HPD	32	EDP_BKLT_EN

Pin	Definition	Pin	Definition
33	EDP_BKLT_CTRL	34	NC
35	NC	36	+12V
37	+12V	38	+12V
39	+12V	40	NC

## M.2 2280/2242 M-key

Connector location: M2M1

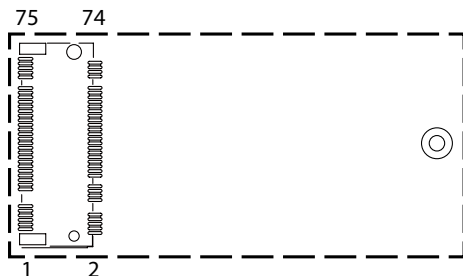

Pin	Definition	Pin	Definition
1	GND	2	+3VSB
3	GND	4	+3VSB
5	PCIE4_RXN	6	NC
7	PCIE4_RXP	8	NC
9	GND	10	M2M_LED#
11	PCIE4_RXN	12	+3VSB
13	PCIE4_RXP	14	+3VSB
15	GND	16	+3VSB
17	PCIE3_RXN	18	+3VSB
19	PCIE3_RXP	20	NC
21	GND	22	NC
23	PCIE3_RXN	24	NC
25	PCIE3_RXP	26	NC
27	GND	28	NC
29	PCIE2_RXN	30	NC
31	PCIE2_RXP	32	NC

Pin	Definition	Pin	Definition
33	GND	34	NC
35	PCIE2_RXN	36	NC
37	PCIE2_RXP	38	DEVSLP
39	GND	40	NC
41	PCIE1_RXP	42	NC
43	PCIE1_RXN	44	NC
45	GND	46	NC
47	PCIE1_TXN	48	NC
49	PCIE1_TXP	50	RESET#
51	GND	52	CLKREQ#
53	CLK_PCIEN	54	WAKE#
55	CLK_PCIEP	56	NC
57	GND	58	NC
67	NC	68	
69	M2M_PEDET	70	+3VSB
71	GND	72	+3VSB
73	GND	74	+3VSB
75	GND		

## M.2 2230 E-key

Connector location: M2E1

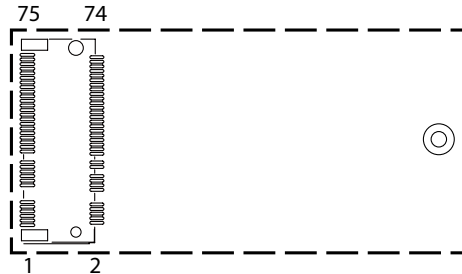

Pin	Definition	Pin	Definition
1	GND	2	3VSB
3	USBP	4	3VSB
5	USBN	6	NC
7	GND	8	NC
9	NC	10	NC
11	NC	12	NC
13	NC	14	NC
15	NC	16	NC
17	NC	18	NC
19	NC	20	NC
21	NC	22	NC
23	NC		
		32	NC
33	GND	34	NC
35	PCIE_TXP	36	NC

Pin	Definition	Pin	Definition
37	PCIE_TXN	38	NC
39	GND	40	NC
41	PCIE_RXP	42	NC
43	PCIE_RXN	44	NC
45	GND	46	NC
47	CLK_PCIEP	48	NC
49	CLK_PCIEN	50	SUSCLK
51	GND	52	PLTRST#
53	CLKREQ#	54	BT_DISABLE#
55	WAKE#	56	WIFI_DISABLE#
57	GND	58	NC
59	NC	60	NC
61	NC	62	NC
63	GND	64	NC
65	NC	66	NC
67	NC	68	NC
69	GND	70	NC
71	NC	72	3VSB
73	NC	74	3VSB
75	GND	76	

# Block Diagram

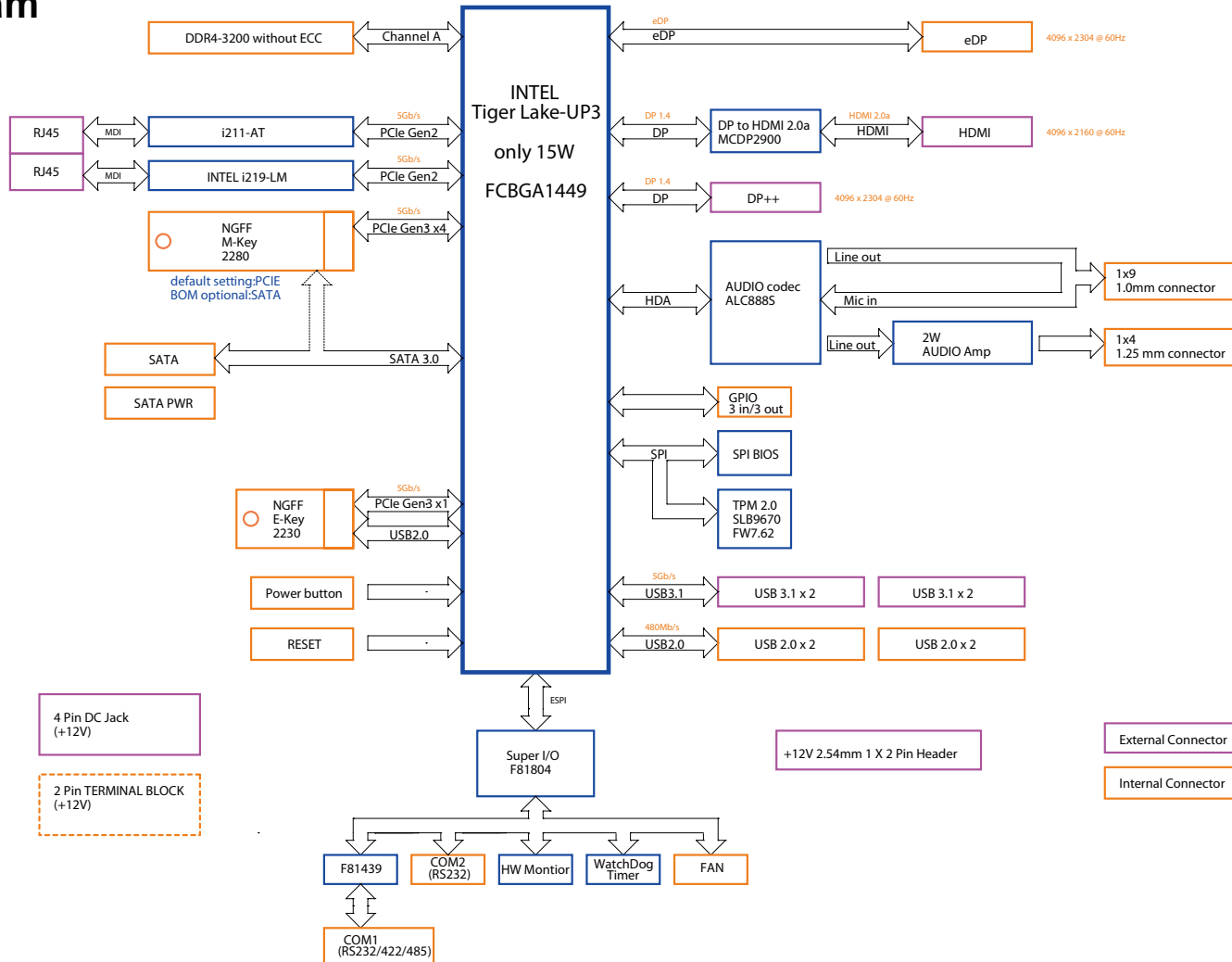

# CHAPTER 3: SYSTEM SETUP

## Removing the Top Cover from the Chassis

1. Remove the 7 screws from the top cover, then lift up the system chassis box to access the mainboard.

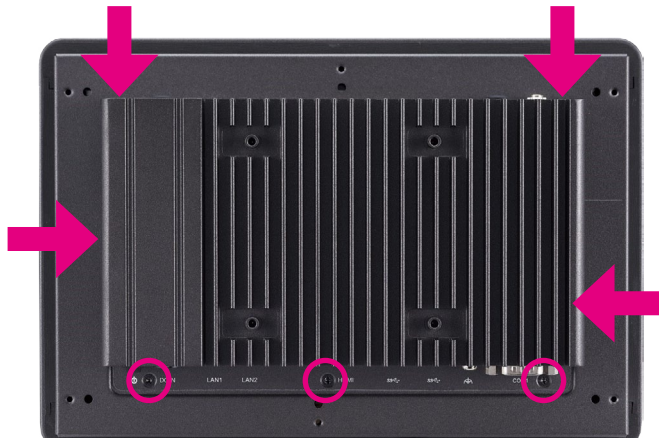

## Installing DDR, SSD, WiFi module

1. With the top cover removed, install DDR, SSD.

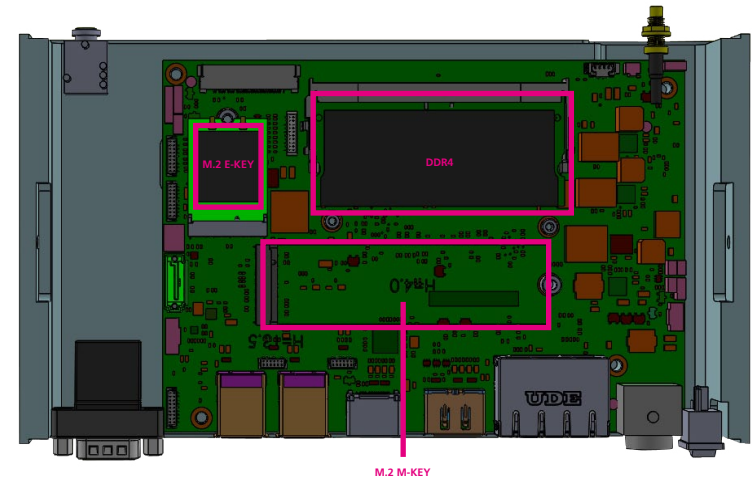

Prior to removing the top cover, make sure the unit's power is off and disconnected from the power sources to prevent electric shock or system damage.

## Installing VESA Mount Kit

1. Align the mounting holes on the VESA mount bracket to the VESA mounting holes on the back of the panel PC, then secure the VESA mount bracket with screws.

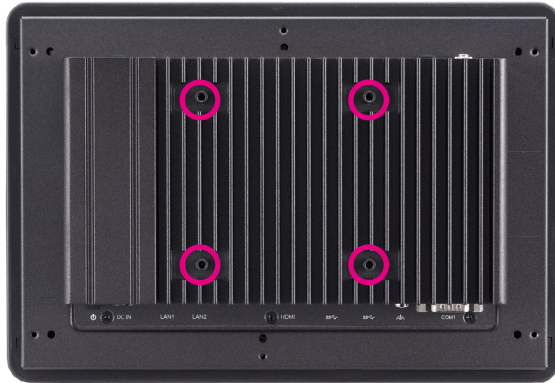

Recommended screws for the VESA mount kit:  
4 \* M4x8 screws.

## Installing Open Frame Kit

1. Turn to the rear side of the panel PC and align the mounting holes on the open frame bracket to the open frame mounting holes on the panel PC, then secure the open frame bracket with screws.



4 \* Screws (I3x5ISO+NYLOK)



## System Dimensions with Open Frame Kit

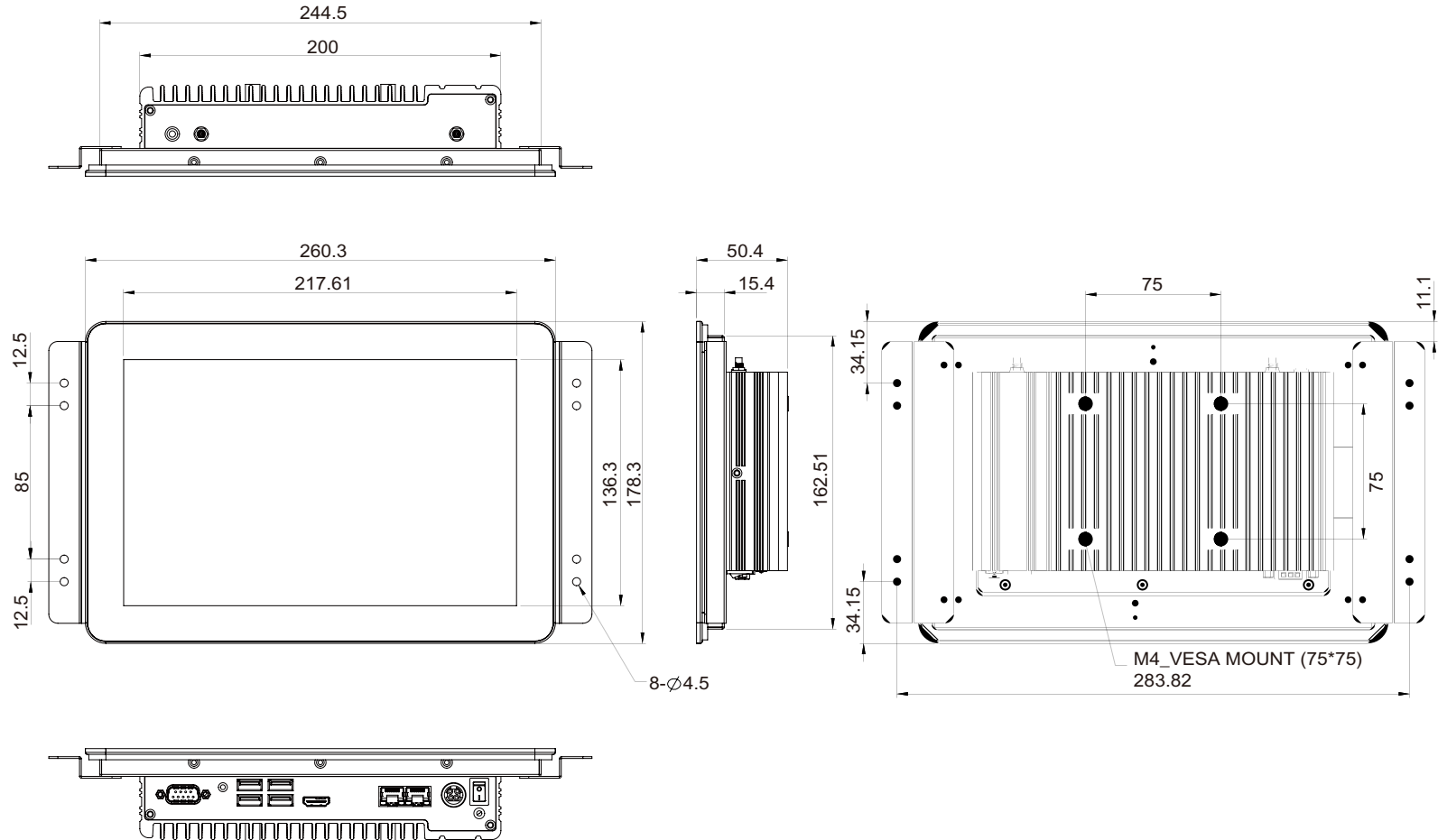

## Panel Mounting

1. Select a place on the panel where you will mount the panel PC.
2. Cut out a shape on the panel that corresponds to the panel PC's rear dimensions.

The thickness of the panel (e.g. steel board, plank, acrylic board, wall, etc.) where you will mount the panel PC must not exceed 9.5mm. If the distance between the front bezel and panel mount hole is too wide, it will not fit the panel mount kit.

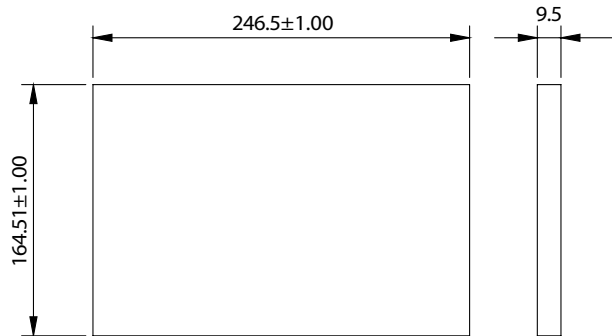

CUT OUT SIZE=9.5mm (MAX)

3. Slide the panel PC through the hole until it is properly fitted against the panel.

4. Position the mounting clamps along the rear edges of the panel PC. The first and second clamps must be positioned and secured diagonally prior to mounting the rest of the clamps.

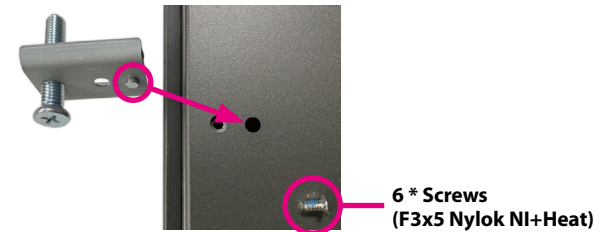
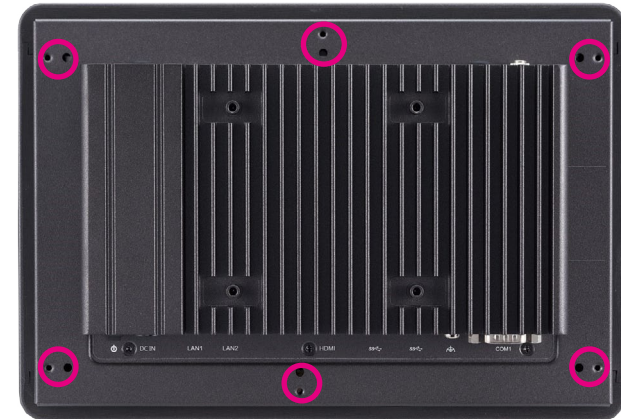

5. Tighten the clamp's screw until it touches the panel.

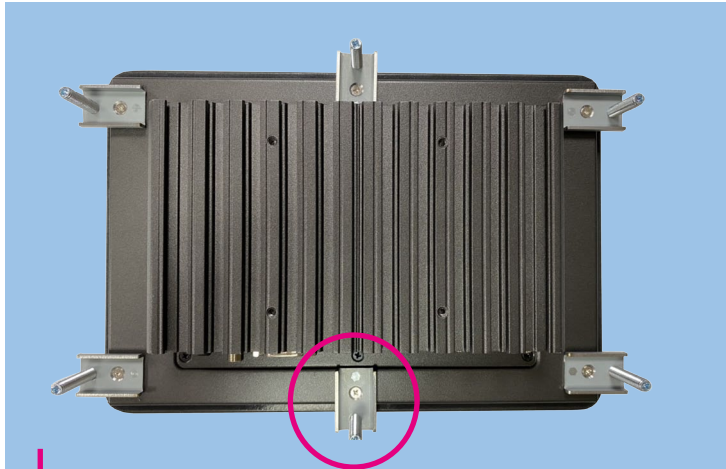

Panel

Clamp



Do not overtighten the screws to prevent damaging the Panel PC.

# CHAPTER 4: BIOS SETUP

This chapter describes how to use the BIOS setup program for XPPC 10-200. The BIOS screens provided in this chapter are for reference only and may change if the BIOS is updated in the future.

To check for the latest updates and revisions, visit the NEXCOM website at [www.nexcom.com.tw](http://www.nexcom.com.tw).

## About BIOS Setup

The BIOS (Basic Input and Output System) Setup program is a menu driven utility that enables you to make changes to the system configuration and tailor your system to suit your individual work needs. It is a ROM-based configuration utility that displays the system's configuration status and provides you with a tool to set system parameters.

These parameters are stored in non-volatile battery-backed-up CMOS RAM that saves this information even when the power is turned off. When the system is turned back on, the system is configured with the values found in CMOS.

With easy-to-use pull down menus, you can configure such items as:

- Hard drives, diskette drives, and peripherals
- Video display type and display options
- Password protection from unauthorized use
- Power management features

The settings made in the setup program affect how the computer performs. It is important, therefore, first to try to understand all the setup options, and second, to make settings appropriate for the way you use the computer.

## When to Configure the BIOS

- This program should be executed under the following conditions:
  - When changing the system configuration
  - When a configuration error is detected by the system and you are prompted to make changes to the setup program
  - When resetting the system clock
  - When redefining the communication ports to prevent any conflicts
  - When making changes to the Power Management configuration
  - When changing the password or making other changes to the security setup

Normally, CMOS setup is needed when the system hardware is not consistent with the information contained in the CMOS RAM, whenever the CMOS RAM has lost power, or the system features need to be changed.

## Default Configuration

Most of the configuration settings are either predefined according to the Load Optimal Defaults settings which are stored in the BIOS or are automatically detected and configured without requiring any actions. There are a few settings that you may need to change depending on your system configuration.

## Entering Setup











When the system is powered on, the BIOS will enter the Power-On Self Test (POST) routines. These routines perform various diagnostic checks; if an error is encountered, the error will be reported in one of two different ways:

- If the error occurs before the display device is initialized, a series of beeps will be transmitted.
- If the error occurs after the display device is initialized, the screen will display the error message.

Powering on the computer and immediately pressing <Del> allows you to enter Setup.

Press the  key to enter Setup:

## Legends

Key	Function
	Moves the highlight left or right to select a menu.
	Moves the highlight up or down between sub-menus or fields.
	Exits the BIOS Setup Utility.
	Scrolls forward through the values or options of the highlighted field.
	Scrolls backward through the values or options of the highlighted field.
	Selects a field.
	Displays General Help.
	Load previous values.
	Load optimized default values.
	Saves and exits the Setup program.
	Press <Enter> to enter the highlighted sub-menu

## Scroll Bar

When a scroll bar appears to the right of the setup screen, it indicates that there are more available fields not shown on the screen. Use the up and down arrow keys to scroll through all the available fields.

## Submenu

When “▶” appears on the left of a particular field, it indicates that a submenu which contains additional options are available for that field. To display the submenu, move the highlight to that field and press  .

## BIOS Setup Utility

Once you enter the AMI BIOS Setup Utility, the Main Menu will appear on the screen. The main menu allows you to select from several setup functions and one exit. Use arrow keys to select among the items and press  to accept or enter the submenu.

### Main

The Main menu is the first screen that you will see when you enter the BIOS Setup Utility.

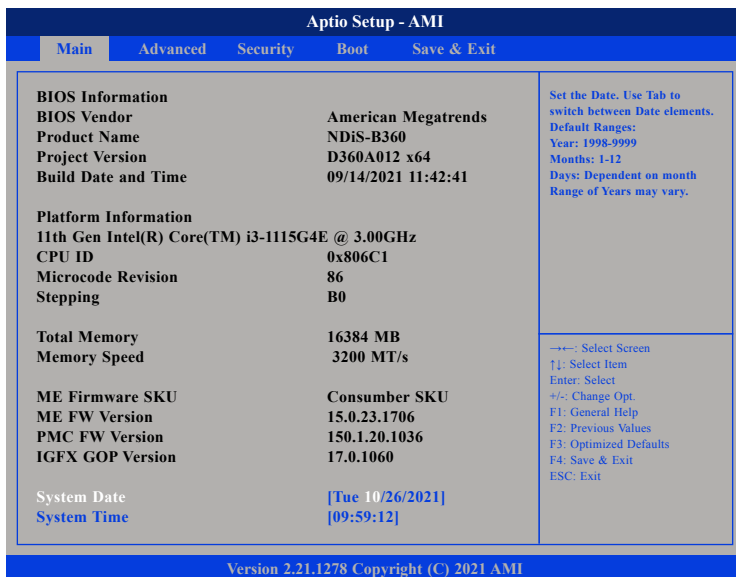

Aptio Setup - AMI				
Main	Advanced	Security	Boot	Save & Exit
<b>BIOS Information</b>				Set the Date. Use Tab to switch between Date elements. Default Ranges: Year: 1998-9999 Months: 1-12 Days: Dependent on month Range of Years may vary.
BIOS Vendor	American Megatrends			
Product Name	NDiS-B360			←→: Select Screen ↑↓: Select Item Enter: Select +/-: Change Opt. F1: General Help F2: Previous Values F3: Optimized Defaults F4: Save & Exit ESC: Exit
Project Version	D360A012 x64			
Build Date and Time	09/14/2021 11:42:41			
<b>Platform Information</b>				
11th Gen Intel(R) Core(TM) i3-1115G4E @ 3.00GHz				
CPU ID	0x806C1			
Microcode Revision	86			
Stepping	B0			
Total Memory	16384 MB			
Memory Speed	3200 MT/s			
<b>ME Firmware SKU</b>		Consumer SKU		
ME FW Version	15.0.23.1706			
PMC FW Version	150.1.20.1036			
IGFX GOP Version	17.0.1060			
System Date	[Tue 10/26/2021]			
System Time	[09:59:12]			
Version 2.21.1278 Copyright (C) 2021 AMI				

### System Date

The date format is <day>, <month>, <date>, <year>. Day displays a day, from Monday to Sunday. Month displays the month, from January to December. Date displays the date, from 1 to 31. Year displays the year, from 2005 to 2099.

### System Time

The time format is <hour>, <minute>, <second>. The time is based on the 24-hour military-time clock. For example, 1 p.m. is 13:00:00. Hour displays hours from 00 to 23. Minute displays minutes from 00 to 59. Second displays seconds from 00 to 59.

## Advanced

The Advanced menu allows you to configure your system for basic operation. Some entries are defaults required by the system board, while others, if enabled, will improve the performance of your system or let you set some features according to your preference.



Setting incorrect field values may cause the system to malfunction.

### State after G3

Configures which state to enter when power is re-applied after a power failure (G3 state).

### Wake on LAN Enable

Enables or disables integrated LAN to wake the system.

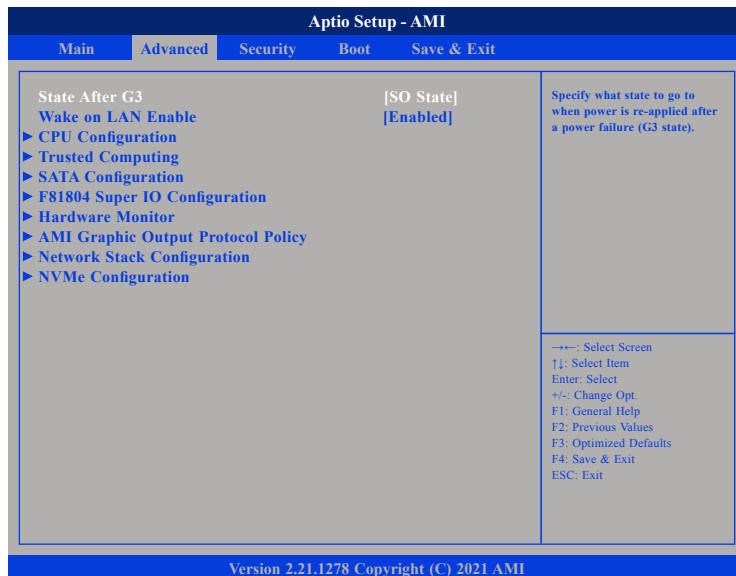



## CPU Configuration

This section is used to view CPU status and configure CPU parameters.

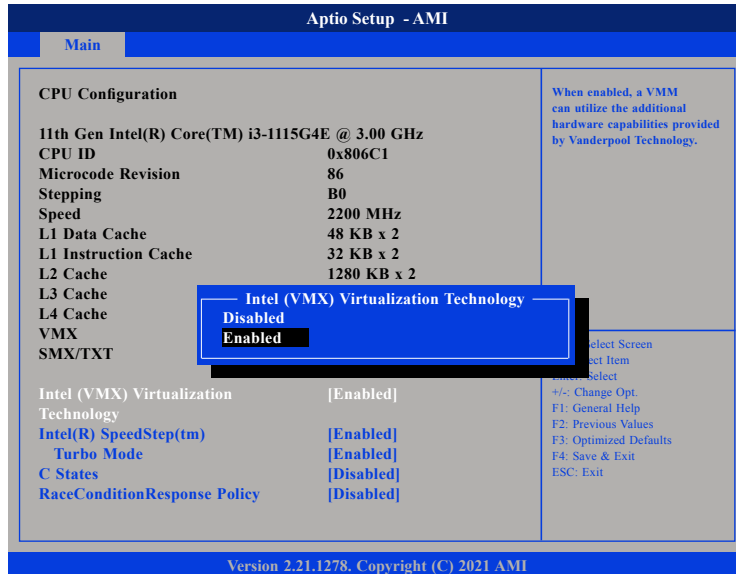

### Intel® Virtualization Technology

When this field is set to Enabled, the VMM can utilize the additional hardware capabilities provided by Vanderpool Technology.

### Intel® SpeedStep™

Enables or disables Intel SpeedStep.

### Turbo Mode

Enables or disables turbo mode.

### C States

Enables or disables CPU power management. Allows CPU to go to C states when it's not 100% utilized.

### RaceConditionResponse Policy

Enables or disables race condition response discovered.

## Trusted Computing

This section is used to configure Trusted Platform Module (TPM) settings.

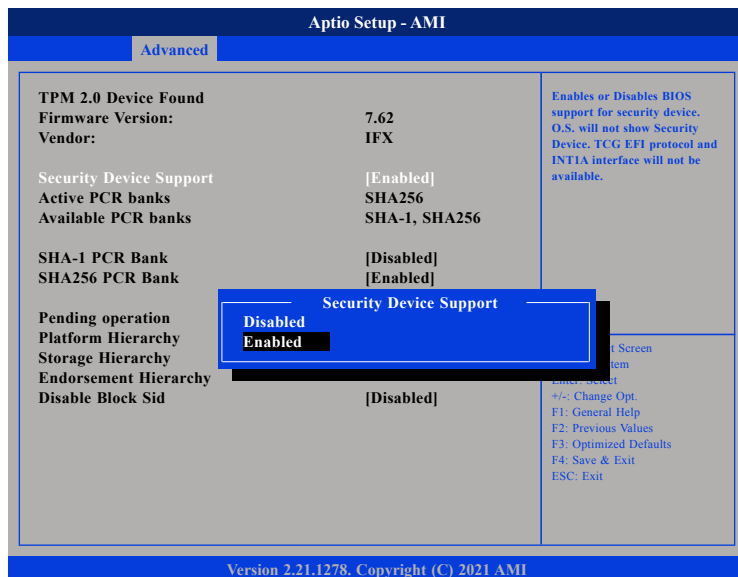

## Pending operation

Schedules an operation for the security device.

## Platform Hierarchy

Enables or disables Platform Hierarchy.

## Storage Hierarchy

Enables or disables Storage Hierarchy.

## Endorsement Hierarchy

Enables or disables Endorsement Hierarchy.

## Disable Block Sid

Override to allow SID authentication in TCG storage device.

## Security Device Support

Enables or disables BIOS support for security device. O.S will not show Security Device. TCG EFI protocol and INT1A interface will not be available.

## SHA-1 PCR Bank

Enables or disables SHA-1 PCR Bank.

## SHA256 PCR Bank

Enables or disables SHA256 PCR Bank

## SATA Configuration

This section is used to configure .

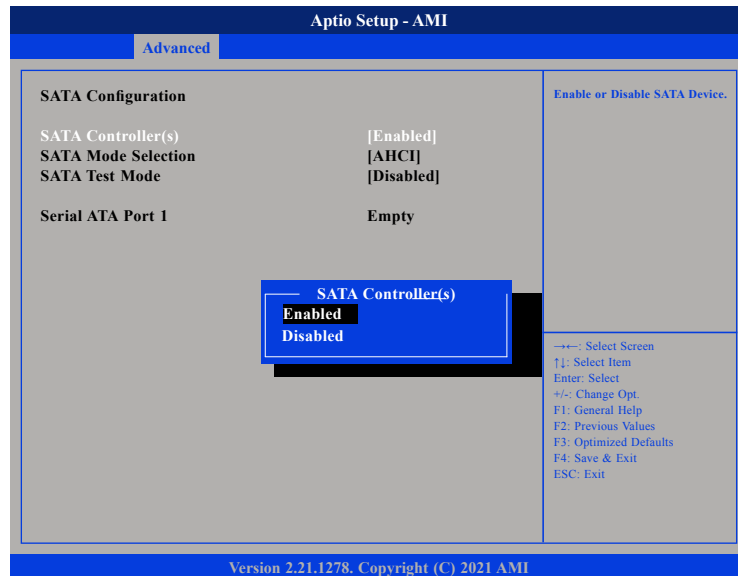

### SATA Controller(s)

Enables or disables the SATA controller.

### SATA Mode Selection

Configures the SATA as AHCI mode.

**AHCI** This option configures the Serial ATA drives to use AHCI (Advanced Host Controller Interface). AHCI allows the storage driver to enable the advanced Serial ATA features which will increase storage performance.

### SATA Test Mode

Enables or disables SATA test mode.

## F81804 Super IO Configuration

This section is used to configure the serial ports.

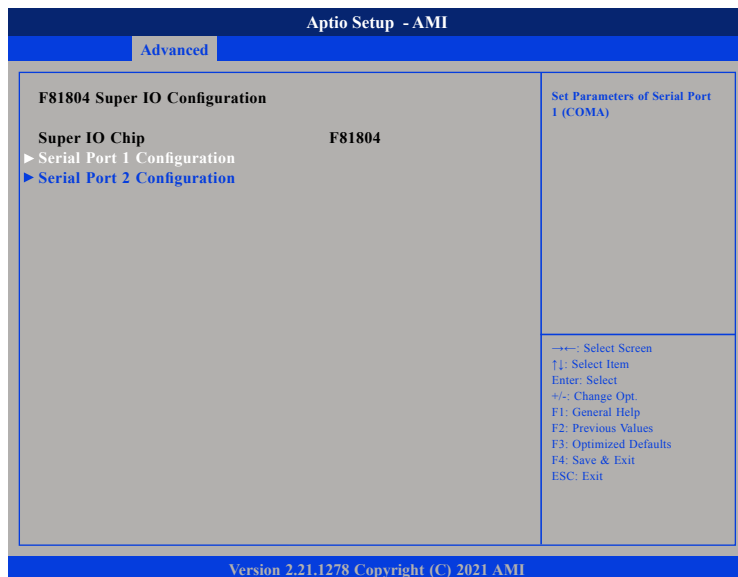

### Super IO Chip

Displays the Super I/O chip used on the board.

## Serial Port 1 Configuration

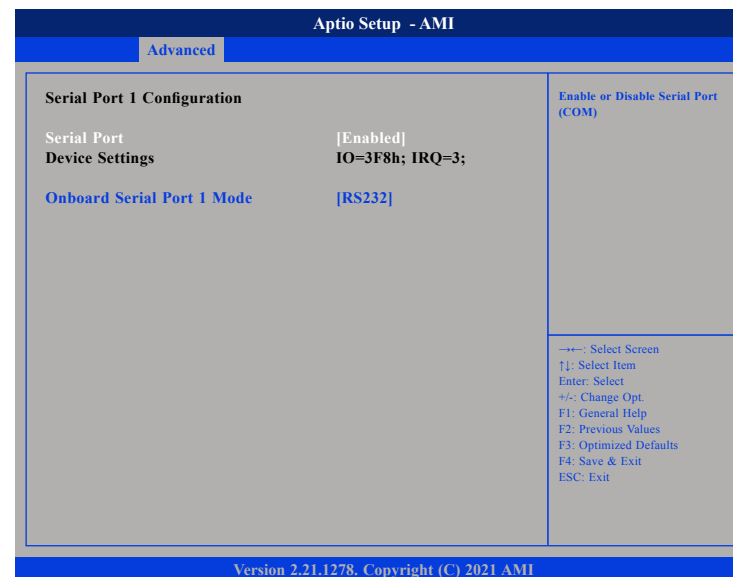

### Serial Port

Enables or disables the serial COM port.

### Device Settings

Displays the IO address and IRQ of the serial COM port.

### Onboard Serial Port Mode

Select this to change the serial port mode to RS232, RS422, RS485.

## Serial Port 2 Configuration

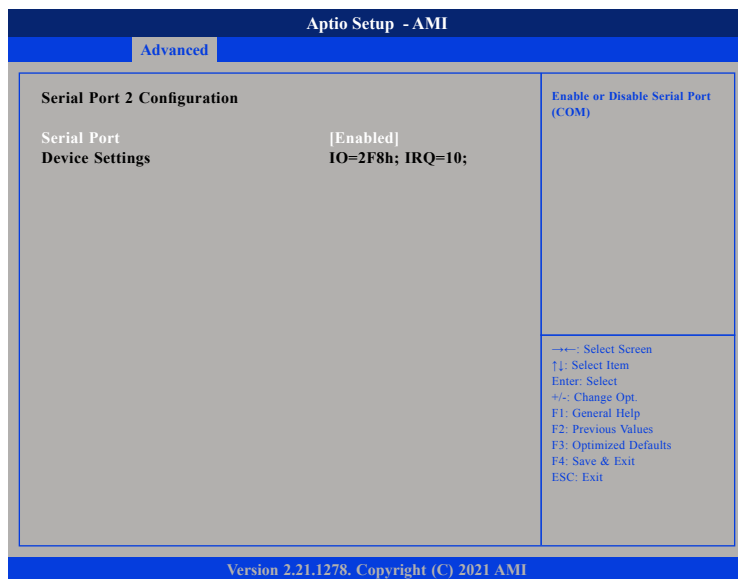

### Serial Port

Enables or disables the serial COM port.

### Device Settings

Displays the IO address and IRQ of the serial COM port.

## Hardware Monitor

This section is used to monitor hardware status such as temperature, fan speed and voltages.

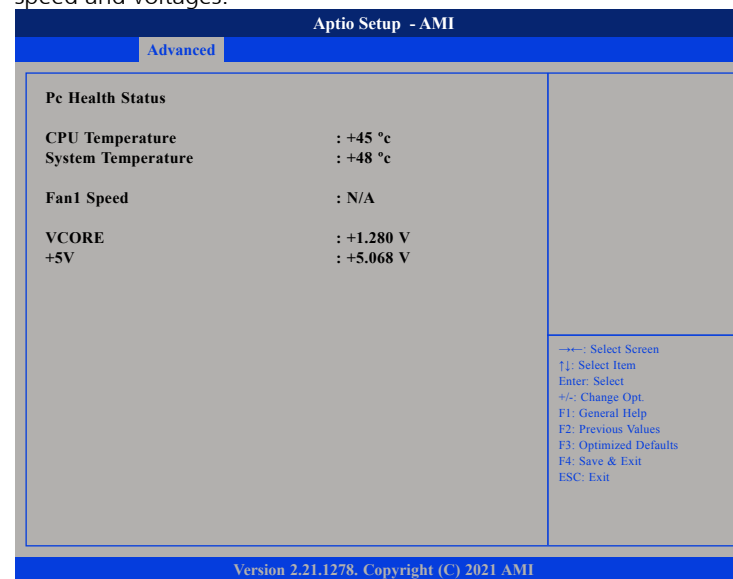

### CPU Temperature

Detects and displays the current CPU temperature.

### System Temperature

Detects and displays the current system temperature.

### Fan1 Speed

Detects and displays the current fan speed.

### Vcore

Detects and displays the Vcore voltage

### +5V

Detects and displays 5V voltage

### AMI Graphic Output Protocol Policy

This section is used to configure the graphics controller settings.

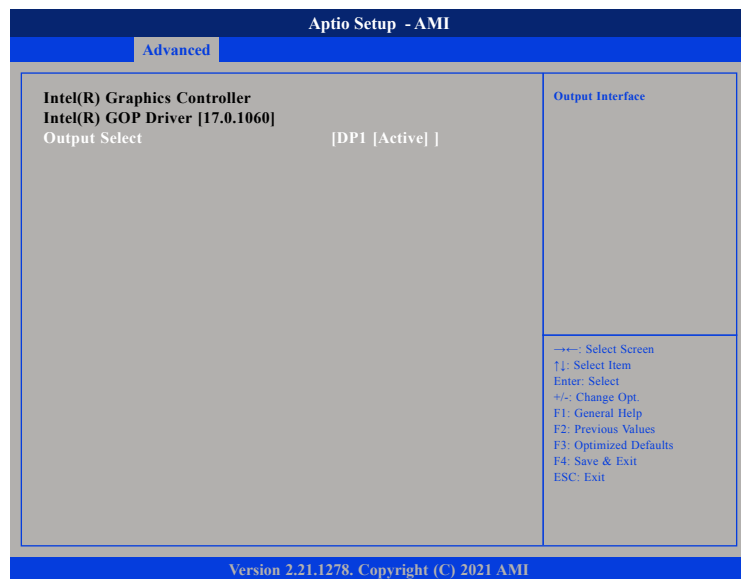

#### Output Select

Configures which display output to use upon boot.

### Network Stack Configuration

This section is used to configure the network stack settings.

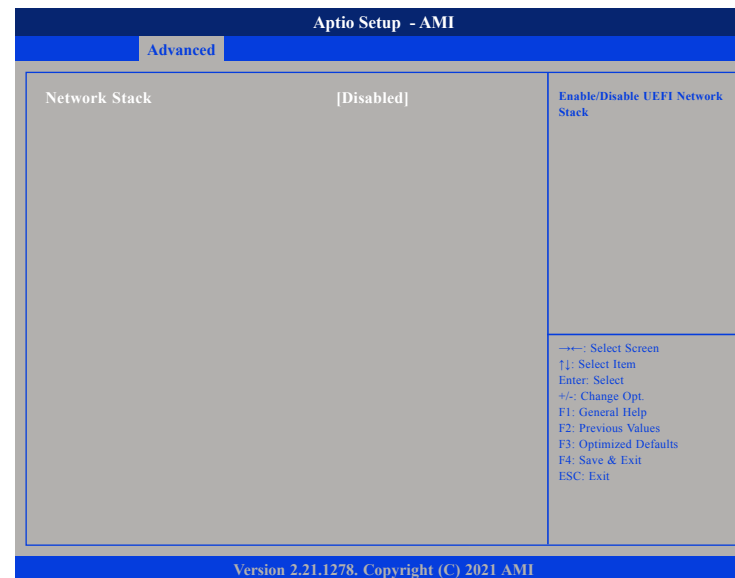

#### Network Stack

Enables or disables UEFI network stack.

## NVMe Configuration

This section is used to display information on the NVMe devices installed.

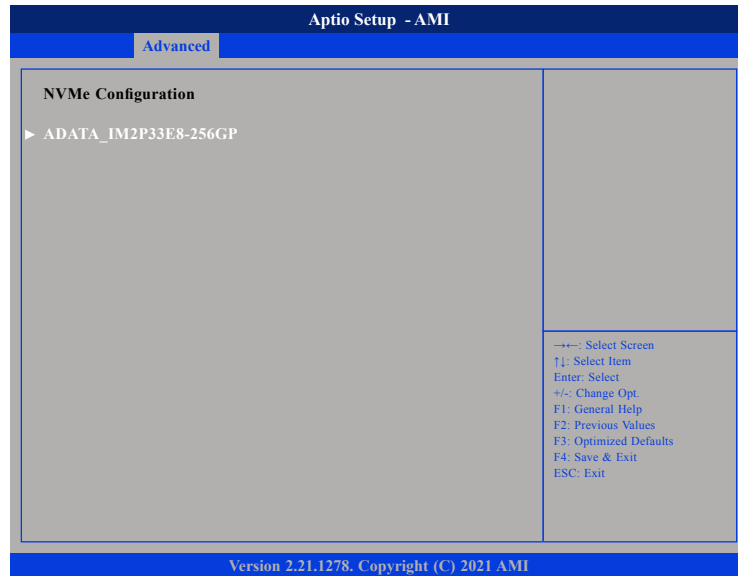

### Output Select

Configures which display output to use upon boot.

## NVMe Device

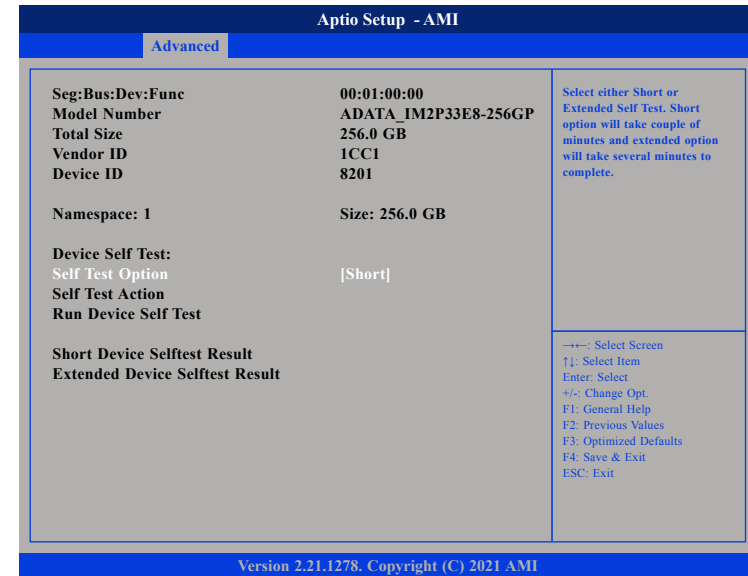

### Self Test Option

Configures the method used for self test.

Short                      Short option will take couple of minutes to complete.  
 Extended                  Extended option will take several minutes to complete.

### Self Test Action

Configures the items used for self test. Controller Only Test and Controller and NameSpace Test options are available. Selecting Controller and NameSpace Test will take longer to complete.

### Run Device Self Test

Run the device self test according to the self test option and action selected. Pressing the Esc key will abort the test.

## Security

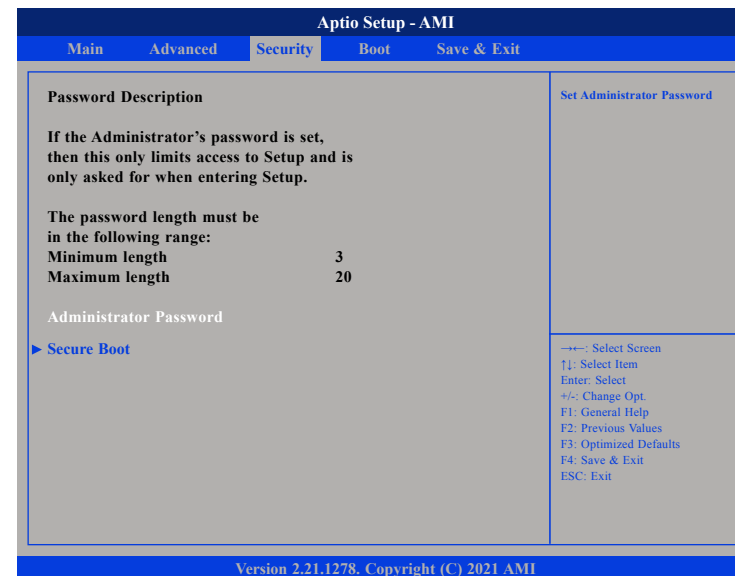

### Administrator Password

Select this to reconfigure the administrator's password.



## Secure Boot

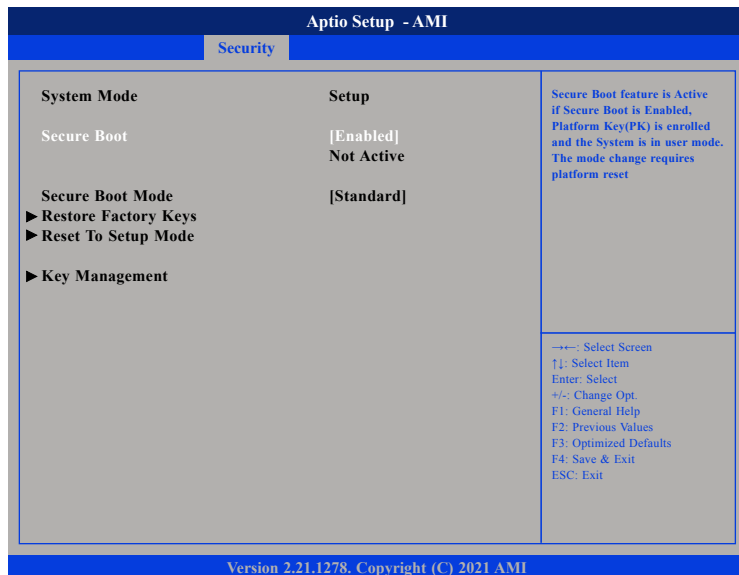

### Secure Boot

Select this to enable or disable Secure Boot. Secure Boot only works when the system runs in user mode.

### Secure Boot Mode

Select this to configure the Secure Boot mode.

Standard	Fixed secure boot policy.
Custom	Secure boot policy variables can be configured by a physically present user without full authentication.

## Boot

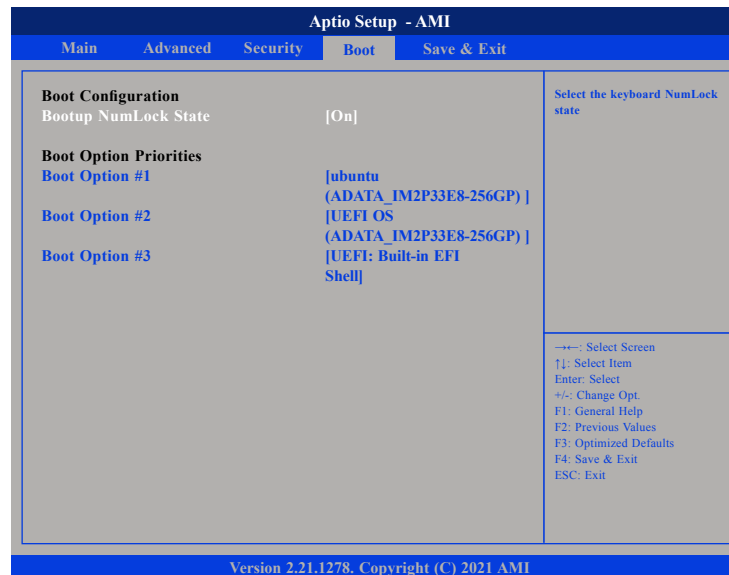

### Bootup NumLock State

This allows you to determine the default state of the numeric keypad. By default, the system boots up with NumLock on wherein the function of the numeric keypad is the number keys. When set to Off, the function of the numeric keypad is the arrow keys

### Boot Option Priorities

Adjust the boot sequence of the system. Boot Option #1 is the first boot device that the system will boot from, next will be #2 and so forth.

## Save & Exit

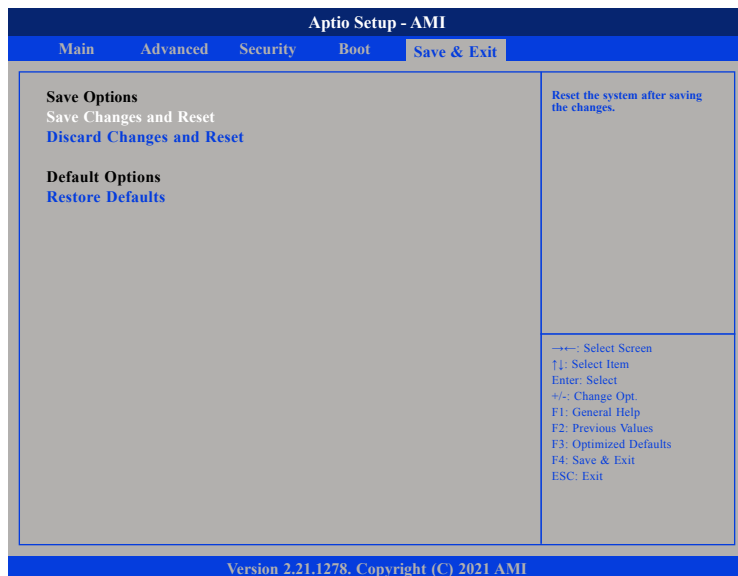

### Save Changes and Reset

To save the changes and reset, select this field then press <Enter>. A dialog box will appear. Confirm by selecting Yes.

### Discard Changes and Reset

To exit the Setup utility and reboot the system without saving the changes, select this field then press <Enter>. You may be prompted to confirm again before exiting.

### Restore Defaults

To restore the BIOS to default settings, select this field then press <Enter>. A dialog box will appear. Confirm by selecting Yes.