

# **EDS-G205A-4PoE Series Quick Installation Guide**

---

**Moxa EtherDevice Switch**

**Version 4.2, January 2021**

**Technical Support Contact Information**  
**[www.moxa.com/support](http://www.moxa.com/support)**

**MOXA<sup>®</sup>**

© 2021 Moxa Inc. All rights reserved.

**P/N: 1802002051026**



## Overview

The EDS-G205A-4PoE series industrial Ethernet switches are rugged entry-level industrial 5-port Gigabit PoE switches for environments that fall under the pollution degree 2 category. The industrial Ethernet switches support IEEE 802.3, IEEE 802.3u, and IEEE 802.3x with 10/100/1000M, full/half-duplex, MDI/MDIX auto-sensing, and IEEE 802.3af/IEEE 802.3at PoE standards.

The EDS-G205A-4PoE series provides 12/24/48 VDC redundant power inputs that can be connected simultaneously to a live DC power source. The switches are available with a standard operating temperature range from 0 to 60°C, or with a wide operating temperature range from -40 to 75°C, and their IP30 metal housing makes them rugged enough for any harsh industrial environment.

To provide greater versatility for use with applications from different industries, the EDS-G205A-4PoE switches also allow users to enable or disable broadcast storm protection, 802.3az, Jumbo frame, and PoE high power with DIP switches on the outer panel. The EDS-G205A-4PoE switches can be easily installed on a DIN-Rail or in distribution boxes. The DIN-Rail mounting capability and IP30 metal housing with LED indicators make the plug-and-play EDS-G205A-4PoE switches reliable and easy to use.

**NOTE** Throughout this Hardware Installation Guide, we use EDS as an abbreviation for Moxa EtherDevice Switch:

**EDS = Moxa EtherDevice Switch**

## Package Checklist

Your EDS is shipped with the following items. If any of these items is missing or damaged, please contact your customer service representative for assistance.

- Moxa EtherDevice™ Switch
- Quick Installation Guide (printed)
- Warranty card

## Features

### ***High-watt Power-over-Ethernet***

- Up to 30 watts output per PoE port (IEEE 802.3at)
- Supports PoE high power output up to 36 W
- Short circuit and over-current protection
- Auto detection for IEEE 802.3af and IEEE 802.3at

### ***High Performance Network Switching Technology***

- 10/100BaseT(X), 1000BaseT and 100/1000BaseX (SFP)
- 10/100/1000M, Full/Half-Duplex, MDI/MDIX auto-sensing
- IEEE 802.3/802.3u/802.3x
- Store and Forward switching process type, 8k MAC address entries
- 10k jumbo frames

### ***Rugged Design***

- Redundant dual 12/24/48 VDC power inputs
- Operating temperature range from 0 to 60°C, or extended operating temperature of -40 to 75°C for (T) models.

- IP30 metal housing
- DIN-rail or panel mounting ability

## EDS-G205A-4PoE Panel Layouts

### Front View

EDS-G205A-4PoE-1GSFP  
SFP Model

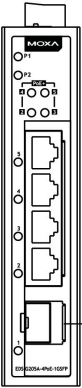

EDS-G205A-4PoE  
Copper Model

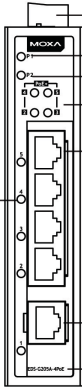

1. Terminal blocks for P1/P2 power inputs
2. Power input P1 LED
3. Power input P2 LED
4. PoE status LED
5. 10/100/1000BaseT(X) PoE ports (ports 2, 3, 4, 5)
6. TP port speed LED
7. 10/100/1000BaseT(X) port (port 1)
8. 100/1000BaseX SFP slot
9. Model name
10. Grounding screw
11. P1 power input terminal block
12. P2 power input terminal block
13. DIP switches
14. Screw holes for panel mounting kit
15. DIN-rail mounting kit

### Top View

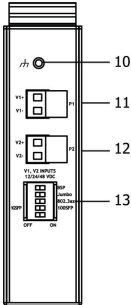

### Rear View

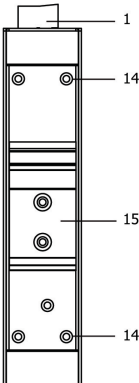

# Mounting Dimensions

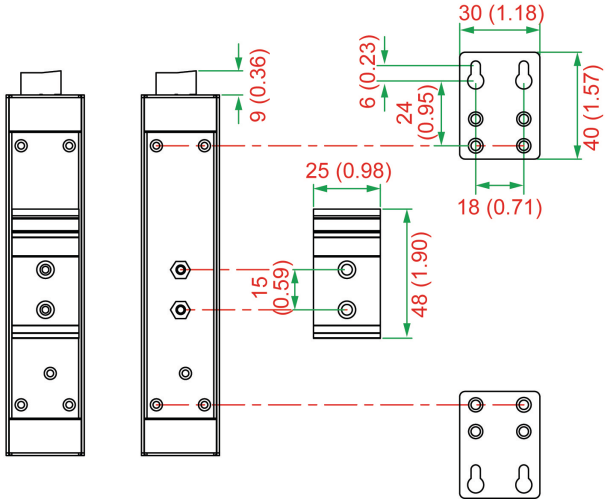
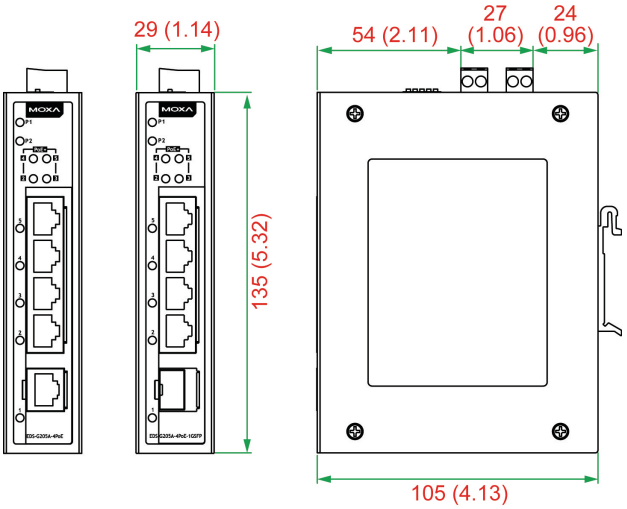

Unit = mm (inch)

## DIN-Rail Mounting

The aluminum DIN-rail attachment plate should already be fixed to the back panel of the EDS when you take it out of the box. If you need to reattach the DIN-rail attachment plate, make sure the stiff metal spring is situated towards the top, as shown in the figures below.

**STEP 1:** Insert the top of the DIN-rail into the slot just below the stiff metal spring.

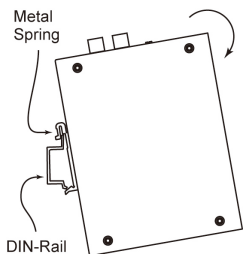

**STEP 2:** The DIN-Rail attachment unit will snap into place as shown below.

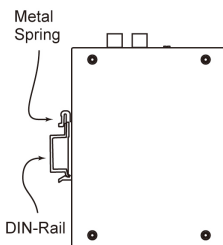

To remove the EDS from the DIN-rail, simply reverse Steps 1 and 2 above.

## Wall Mounting (optional)

For some applications, you will find it convenient to mount the EDS-G205A-4PoE on a wall, as shown in the following figures.

### STEP 1:

Remove the aluminum DIN-rail attachment plate from the EDS-G205A-4PoE's rear panel, and then attach the wall mount plates as shown in the diagram at the right.

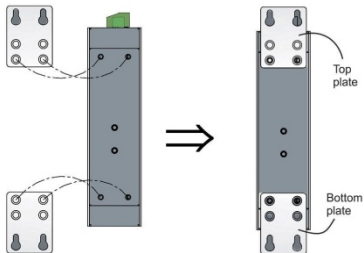

### STEP 2:

Mounting the EDS-G205A-4PoE on the wall requires 4 screws and the recommended tightening torque is  $3.5 \pm 0.5$  (kgf cm). Use the switch, with wall mount plates attached, as a guide to mark the correct locations of the 4 screws. The heads of the screws should be less than 6.0 mm in diameter, and the shafts should be less than 3.5 mm in diameter, as shown in the figure at the right.

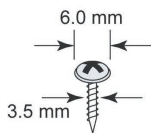

**NOTE** Before tightening the screws into the wall, make sure the screw head and shank size are suitable by inserting the screw into one of the keyhole-shaped apertures of the wall mounting plates. Do not screw the screws in completely—leave about 2 mm to allow room for sliding the wall mount panel between the wall and the screws

### STEP 3:

Once the screws are fixed on the wall, insert the four screw heads through the large parts of the keyhole-shaped apertures, and then slide the EDS downwards, as indicated. Tighten the four screws for added stability.

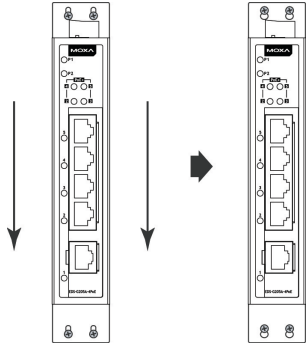

## Wiring Requirements



### WARNING

#### Safety First

Turn the power off before disconnecting modules or wires. The correct power supply voltage is listed on the product label. Check the voltage of your power source to make sure that you are using the correct voltage. Do NOT use a voltage greater than what is specified on the product label

Calculate the maximum possible current in each power wire and common wire. Observe all electrical codes dictating the maximum current allowable for each wire size. If the current goes above the maximum ratings, the wiring could overheat, causing serious damage to your equipment.

You should also pay attention to the following points:

- Use separate paths to route wiring for power and devices. If power wiring and device wiring paths must cross, make sure the wires are perpendicular at the intersection point.  
**NOTE:** Do not run signal or communications wiring and power wiring in the same wire conduit. To avoid interference, wires with different signal characteristics should be routed separately.
- You can use the type of signal transmitted through a wire to determine which wires should be kept separate. The rule of thumb is that wiring that shares similar electrical characteristics can be bundled together.
- Keep input wiring and output wiring separated.
- It is strongly advised that you label wiring to all devices in the system when necessary.
- Please use copper conductor only.

## Grounding the EtherDevice Switch

Grounding and wire routing help limit the effects of noise due to electromagnetic interference (EMI). Run the ground connection from the ground screw to the grounding surface prior to connecting devices.



### ATTENTION

This product is intended to be mounted to a well-grounded mounting surface such as a metal panel.

## Wiring the Redundant Power Inputs

The two 2-contact terminal block connectors on the EDS's top panel are used for the EDS's two DC power inputs. Top and front views of the terminal block connectors are shown here.

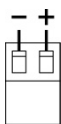

Top View

#### STEP 1:

Insert the negative/positive DC wires into the V-/V+ terminals.

#### STEP 2:

To keep the DC wires from pulling loose, use a small flat-blade screwdriver to tighten the wire-clamp screws on the front of the terminal block connector.

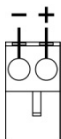

Front View

#### STEP 3:

Insert the plastic terminal block connector prongs into the terminal block receptor, which is located on the EDS's top panel.



### ATTENTION

Before connecting the EtherDevice Switch to the DC power inputs, make sure the DC power source voltage is stable and the DC power source is supplied by UL Listed Isolated Power Supply.

## Communication Connections

The EDS-G205A-4PoE switches have 4 10/100/1000Base-T(X) PoE Ethernet ports for connecting PoE devices, and 1 10/100/1000BaseT port or 1 100/1000BaseX SFP slot for uplink connection. For fiber connections, a field installed optical transceiver must be UL Recognized, in the Class I category, and contain the following CDRH Certification Marking: 'Complies with 21CFR 1040.10 and 1040.11'.

### 10/100/1000BaseT(X) Ethernet Port Connection

10/100/1000BaseT(X) ports located on the EDS's front panel are used to connect to Ethernet-enabled devices. Below we show pinouts for both MDI (NIC-type) ports and MDI-X (HUB/switch-type) ports, and also show cable wiring diagrams for straight-through and cross-over Ethernet cables.

## 10/100BaseT(x) RJ45 Pinouts

### MDI Port Pinouts

Pin	Signal
1	Tx+
2	Tx-
3	Rx+
6	Rx-

### MDI-X Port Pinouts

Pin	Signal
1	Rx+
2	Rx-
3	Tx+
6	Tx-

### 8-pin RJ45

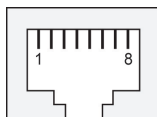

## 1000BaseT RJ45 Pinouts

Pin	MDI	MDI-X
1	BI_DA+	BI_DB+
2	BI_DA-	BI_DB-
3	BI_DB+	BI_DA+
4	BI_DC+	BI_DD+
5	BI_DC-	BI_DD-
6	BI_DB-	BI_DA-
7	BI_DD+	BI_DC+
8	BI_DD-	BI_DC-

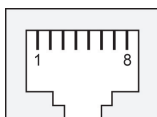

## PoE Ethernet Port Connection

PoE ports located on the EDS switch's front panel are used to connect to PoE-enabled devices. The pinout follows the Alternative A, MDI mode of 802.3af/802.3at standards. Details are shown below.

### PoE Port Pinouts

Pin	Power
1	V+
2	V+
3	V-
6	V-

### 8-pin RJ45

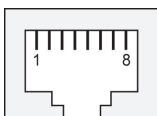

**NOTE** According to IEEE 802.3af/at standards, the PD shall be implemented to be insensitive to the polarity of the power supply and shall be able to operate per MDI mode and MDI-X mode. However, some PDs only support MDI mode or MDI-X mode only. The following figures show how to select the correct cable to connect between the PD and EDS-G205A-4PoE.

## RJ45 (8-pin) to RJ45 (8-pin) Straight-Through Cable Wiring

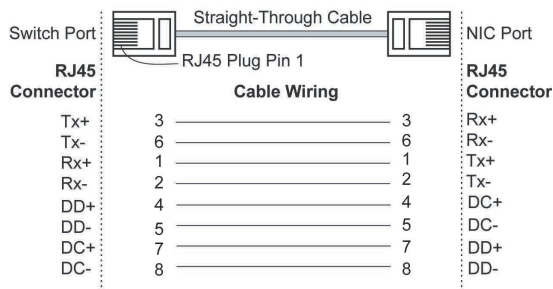



## RJ45 (8-pin) to RJ45 (8-pin) Cross-Over Cable Wiring

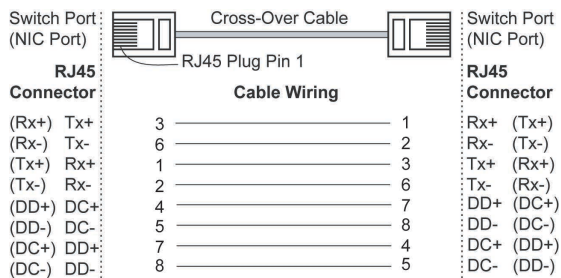

**NOTE** If the PD only supports PoE MDI mode (V+, V+, V-, V- for pins 1, 2, 3, 6), choose a cross-over Ethernet cable to connect the PD and the EDS switch. If the PD only supports PoE MDI-X mode (V-, V-, V+, V+ for pins 1, 2, 3, 6), choose a straight-through Ethernet cable between the PD and the EDS switch.

## Redundant Power Inputs

Both power inputs can be connected simultaneously to live DC power sources. If one power source fails, the other live source acts as a backup, and automatically supplies all of the EDS's power needs.

## DIP Switch Settings

The default setting for each DIP Switch is OFF. The following table explains the effect of setting the DIP Switches to the ON positions.

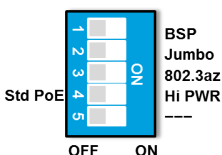

**EDS-G205A-4PoE  
(Copper Model)**

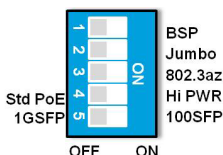

**EDS-G205A-4PoE-1GSFP  
(SFP Model)**

DIP Switch	Setting	Description
BSP	ON	Enable broadcast storm protection
	OFF	Disable broadcast storm protection
Jumbo Frame	ON	Enable jumbo frame function
	OFF	Disable jumbo frame function
802.3az	ON	Enable the energy-efficient Ethernet function
	OFF	Disable the energy-efficient Ethernet function
PoE High Power	ON	Supports PoE high power output up to 36 W. PoE high power is activated when an 802.3af or 802.3at connection is detected.
	OFF	Supports standard PoE power output up to 30 W
100/1G SFP (For SFP model only)	ON	Supports 100M SFP module
	OFF	Supports 1000M SFP module
---	-	Serves no function (reserved for future use)



## ATTENTION

To actively update DIP switch settings, power off and then power on the EDS.

## LED Indicators

The front panel of the EDS switches contain several LED indicators. The function of each LED is described in the following table.

LED	Color	State	Description
P1	AMBER	On	Power is being supplied to power input P1.
		Off	Power is <b>not</b> being supplied to power input P1.
P2	AMBER	On	Power is being supplied to power input P2.
		Off	Power is <b>not</b> being supplied to power input P2.
10/100/ 1000	AMBER	On	TP port's 10/100 Mbps or SFP port's 100 Mbps link is active.
		Blinking	Data is being transmitted at 10/100 Mbps.
		Off	TP port's 10/100 Mbps or SFP port's 100 Mbps link is inactive.
	GREEN	On	TP/SFP port's 1000 Mbps link is active.
		Blinking	Data is being transmitted at 1000 Mbps.
		Off	TP/SFP port's 1000 Mbps link is inactive.
PoE+	AMBER	On	The PoE device is connected by the IEEE 802.3af standard
		Blinking (1 time/s)	The PoE power has been shut off because the power budget is too low.
		Off	No PoE power output or no PoE connected PoE devices
	Green	On	The PoE device is connected by IEEE 802.3at standard or PoE High Power
		Off	No PoE power output or no PoE connected PoE devices
	Red	Blinking	- 1 time/s: PoE standard detection failure
			- 2 times/s: PoE current overload
Off	No PoE failure		

## Auto MDI/MDI-X Connection

The Auto MDI/MDI-X function allows users to connect the EDS's 10/100/1000BaseT(X) ports to any kind of Ethernet device, without needing to pay attention to the type of Ethernet cable being used for the connection. This means that you can use either a straight-through cable or cross-over cable to connect the EDS to Ethernet devices.

## Triple Speed Functionality and Switching

The Moxa EtherDevice Switch's 10/100/1000 Mbps switched RJ45 port auto negotiates with the connected device for the fastest data transmission rate supported by both devices. All models of Moxa EtherDevice Switch are plug-and-play devices, so that software configuration is not required at installation, or during maintenance. The half/full duplex mode for the switched RJ45 ports is user dependent and changes (by auto-negotiation) to full or half duplex, depending on which transmission speed is supported by the attached device.

## Jumbo Frame

The EDS-G205A-4PoE series supports Ethernet jumbo frames up to 10k, which is with more than 1500 bytes of payload. This function is by default disabled and can be enabled by turning on the DIP switch labeled "Jumbo" on the top cover. This is commonly used for large packet size applications such as video surveillance.

## Broadcast Storm Protection

The EDS-G205A-4PoE Series has a built-in algorithm for limiting the amount of broadcast packets through the switch. This function is by default disabled and can be enabled by turning on the DIP switch labeled "BSP" on the top cover. If the broadcast storm protection algorithm detects more than 2k broadcast frames per second, then the switch will be suppressed from receiving broadcast frames for a period of 2 ms to prevent any further flooding.

## Total Power Budget

For the total power budget, the EDS-G205A-4PoE will provide 62 W at 12 to 17 VDC input, 120 W at 18 to 35 VDC input, and 144 W at 36 to 57 VDC input. The total power budget is the total amount of reserved PoE power based on the PoE class of the PoE device. If a newly connected PoE device causes the total reserved power to exceed the total power budget, the newly connected PoE device will be denied power.

Input Voltage	Total Power Budget
12 VDC (12 to 17 VDC)	62 W
24 VDC (18 to 35 VDC)	120 W
48 VDC (36 to 57 VDC)	144 W

PoE Class	Reserved Power
0	15.4 W
1	4.0 W
2	7.0 W
3	15.4 W
4	30 W

## PoE High Power Application

PoE High Power can be enabled by DIP switch, and supply up to 36 W of PoE power when the PSE detects an 802.3af or 802.3at connection. Refer to the table below for the power budget at different input voltages, and for the number of PoE High Power Ports supported.

Input Voltage	Total Power Budget	Number of PoE High Power Ports
12 VDC (12 to 17 VDC)	62 W	Up to 1 PoE high power port (36 W)
24 VDC (18 to 35 VDC)	120 W	Up to 3 PoE high power port (36 W)
48 VDC (36 to 57 VDC)	144 W	Up to 4 PoE high power port (36 W)

## Specifications

Technology	
Standards	IEEE 802.3 for 10BaseT, IEEE 802.3u for 100BaseT(X) and 100BaseFX, IEEE 802.3ab for 1000BaseT IEEE 802.3z for 1000BaseX IEEE 802.3x for Flow Control IEEE 802.3af for PoE IEEE 802.3at for PoE+
Processing Type	Store and Forward
Interface	
RJ45 Ports	10/100/1000BaseT(X) auto negotiation speed, F/H duplex mode, and auto MDI/MDI-X connection
Fiber Ports	100/1000 BaseX ports (SFP Slot)
LED Indicators	Power: P1, P2 TP Port: 10/100/1000 Fiber Port: 100/1000 PoE Ports: PoE+ for Port 2, 3, 4, 5
DIP Switch	Broadcast Storm Protection, Jumbo Frame, 802.3az, Standard PoE/PoE High Power, 100/1G SFP
PoE	
Total Power Budget	62 W @ 12 VDC (12 to 17 VDC) 120 W @ 24 VDC (18 to 35 VDC) 144 W @ 48 VDC (36 to 57 VDC)
PoE Output Voltage	53 VDC @ 12/24/48 VDC power input
PoE Output Power	15.4 W in 802.3af, 30 W in 802.3at, 36 W in high power mode
PoE Output Current	350 mA in 802.3af, 600 mA in 802.3at, 720 mA in high power mode
Overload Current Protection at Port	Present
PoE Pinout	Mode A: Pair 1, 2 (V+); Pair 3, 6 (V-)

<b>Power</b>	
Input Voltage	12/24/48 VDC, redundant dual inputs
Operating Voltage	12 to 57 VDC
Rated Current	5.92 A @ 12 VDC 5.65 A @ 24 VDC 3.21 A @ 48 VDC
Power Consumption	11.73 W without PDs' consumption
Inrush Current	17.4 A @ 24 VDC (0.1 to 1 ms)
Electrical Isolation	2250 VDC to chassis for 60 s
Heat Dissipation	36.4 BTU/h
Overload Current Protection at Input	Present
Reverse Polarity Protection	Present
Connection	2 removable 2-contact terminal blocks
<b>Physical Characteristics</b>	
Housing	Aluminum, IP30 protection
Dimensions	29 x 135 x 105 mm
Weight	300 g
Installation	DIN-rail mounting, Wall mounting (with optional kit)
<b>Environmental Limits</b>	
Operating Temperature	Standard models: 0 to 60°C (32 to 140°F) Wide temp. models: -40 to 75°C (-40 to 167°F)
Storage Temperature	-40 to 85°C (-40 to 185°F)
Ambient Relative Humidity	5 to 95% (non-condensing)
<b>Standards and Certifications</b>	
Safety	UL 508
EMC	EN 55032/24
EMI	CISPR 32, FCC Part 15B Class A
EMS	IEC 61000-4-2 ESD: Contact: 6 kV; Air: 8 kV IEC 61000-4-3 RS: 80 MHz to 1 GHz: 10 V/m IEC 61000-4-4 EFT: Power: 2 kV; Signal: 2 kV IEC 61000-4-5 Surge: Power: 2 kV; Signal: 2 kV IEC 61000-4-6 CS: 10 V IEC 61000-4-8
Rail Traffic	EN 50121-4
Shock	IEC 60068-2-27
Freefall	IEC 60068-2-32
Vibration	IEC 60068-2-6
<b>WARRANTY</b>	
Time	5 years
Details	<a href="http://www.moxa.com/warranty">www.moxa.com/warranty</a>

Patent [http://www.moxa.com/doc/operations/Moxa\\_Patent\\_Marking.pdf](http://www.moxa.com/doc/operations/Moxa_Patent_Marking.pdf)